

PHILIPS

HD7900



www.philips.com/welcome



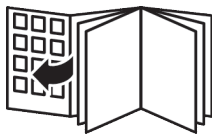

English 6
Čeština 32
Dansk 58
Deutsch 84
Español 111
Français 138
Italiano 164
Latviešu 191
Magyar 217
Nederlands 244
Norsk 271
Polski 297
Português 323
Română 350
Suomi 376
Svenska 402
Türkçe 428
Ελληνικά 454
Български 481
Українська 508
עברית 534

Introduction

Congratulations on your purchase and welcome to Philips!

To fully benefit from the support that Philips offers, register your product at www.philips.com/welcome.

General description

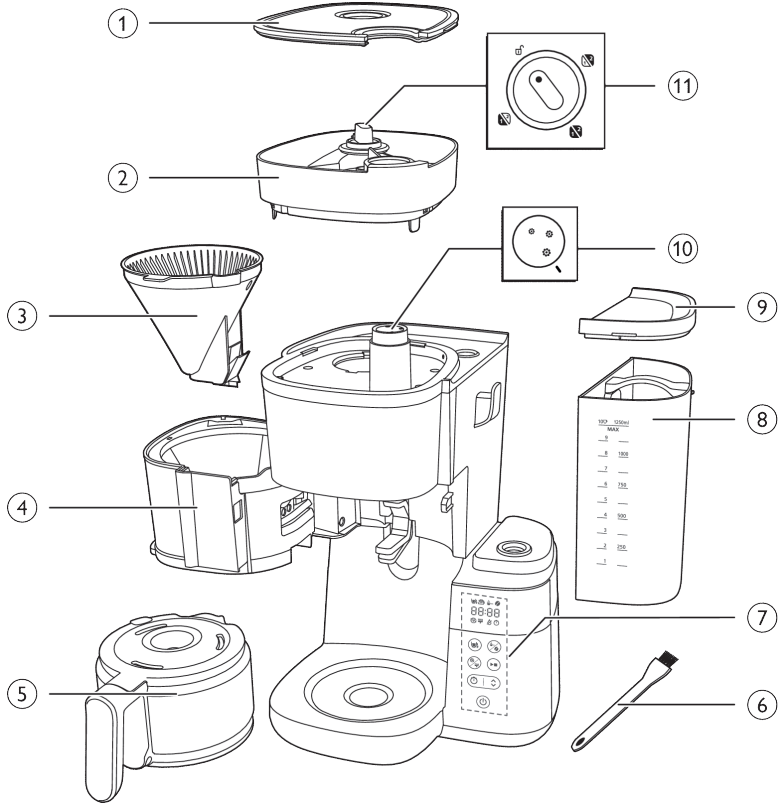

- 1 Bean container lid
- 2 Bean container
- 3 Filter basket
- 4 Filter basket holder
- 5 Glass jug
- 6 Bean chute cleaning brush
- 7 Control panel with display
- 8 Water reservoir
- 9 Water reservoir lid
- 10 Coarseness knob
- 11 Container selector knob

Control panel



Power button



Timer button and arrow button for time adjustment



Start/pause button



Cleaning button



Pre-ground and coffee strength button



Cup selection button

Display icon



Number of cups



Keep warm mode



Pre-ground coffee



Coffee strength



Descaling



Manual cleaning alert



Low water reservation



Timer



Time display

The first two digits represent the hours and the last two digits represent the minutes.



Turn the knob to unlock position, then you can remove the bean contain from the appliance.



This knob selects coffee coarseness, with larger size indicating coarser processing.



Jug mode

Drip stop function exists in jug mode.

Note: The brewing process does not stop when you remove the jug. If you do not put the jug back into the appliance within 20 seconds, the filter basket overflows.



Cup mode

Manually switch the knob from cup to jug mode to open the drip stop to prevent the dripping once the brew cycle is finished

Note: Cold ceramic mug will steal heat from the coffee as it warms itself up, please pre-warmed cup with hot water.

Important

Warning

- Check if the voltage indicated on the appliance corresponds to the local mains voltage before you connect the appliance.
- Connect the appliance to an earthed wall socket.
- Do not use the appliance if the plug, the mains cord or the appliance itself is damaged.
- If the mains cord is damaged, you must have it replaced by Philips, a service center authorized by Philips or similarly qualified persons in order to avoid a hazard.
- This appliance can be used by children aged from 8 years and above and by persons with reduced physical, sensory or mental capabilities or lack of experience and knowledge if they have been given supervision or instruction concerning use of the appliance in a safe way and if they understand the hazards involved. Cleaning and user maintenance shall not be made by children unless they are older than 8 and supervised. Keep the appliance and its cord out of reach of children aged less than 8 years.
- Children shall not play with the appliance.
- Do not let the mains cord hang over the edge of the table or worktop on which the appliance stands.
- Only use this appliance for its intended purpose to avoid potential hazard or injury.

Caution

- Always flush the appliance with fresh water before first use.
- Do not place the appliance on a hot surface and do not let the mains cord come into contact with hot surfaces.
- Do not place the appliance in a cabinet when in use.
- Unplug the appliance before you clean it and if problems occur during brewing.
- Always clean the appliance after the appliance cools down.
- During brewing and keeping warm, the water tank, the filter holder, the hotplate, the lower part of the appliance, and the jug filled with coffee are hot even some time after.
- Do not put the jug on a stove or in a microwave to reheat coffee.
- This appliance is intended to be used in household and similar applications such as farm houses, bed and breakfast type environments, staff kitchen areas in shops, offices and other working environments, and by clients in hotels, motels and other residential type environments.
- Always return the appliance to a service centre authorised by Philips for examination or repair. Do not open the appliance or attempt to repair the appliance yourself.
- The heating element surface, the filter holder, the lower part of the appliance, the hotplate, and the jug filled with coffee are subject to residual heat last for some time after use.
- Unless otherwise indicated, all packaging material in the box is made of recycled paper; see the PAP marking on the box.

Descaling

- Descale the coffee machine when you notice there is a descaling alert appeared on the display. Only use white vinegar to descale, as other products may cause damage to the appliance.

Electromagnetic fields (EMF)

This Philips appliance complies with the standards regarding electromagnetic fields (EMF).

Recycling



This symbol means that this product shall not be disposed of with normal household waste (2012/19/EU).

Follow your country's rules for the separate collection of electrical and electronic products. Correct disposal helps prevent negative consequences for the environment and human health.

Unless otherwise indicated, all packaging material in the box is made of recycled paper; see the PAP marking on the box.

Warranty and support

Versuni offers a two-year warranty after purchase on this product. This warranty is not valid if a defect is due to incorrect use or poor maintenance. Our warranty

does not affect your rights under law as a consumer. For more information or for invoking the warranty, please visit our website www.philips.com/support.

Before first use

Make sure clean the filter holder and permanent filter after every use.

Wipe the filter holder thoroughly with a dry cloth after each use. Make sure clean it of any condensate buildup.

Setting the clock

- 1 Plug in the appliance.
 - The hour display will start flashing.

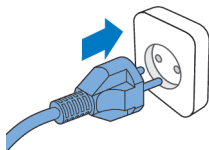

08:00



- 2 Use the arrow button to adjust the hour.

08:



- 3 Once the hour is set, press the timer button to confirm the hour.



- 4 The minutes indication will start flashing. Use the arrow button to adjust the minutes.

08:06



08:06



08:06

5 Press the timer button to confirm the minutes.

- The current time is now set and saved.

6 To adjust timer in standby mode, you can choose between two approaches below:

- Plug off the appliance and and plug in again.
- Press and hold timer button until hour digits starts flash.

Note

The appliance always saves the last setting.

Keep warm time

You can choose how long you want your coffee to stay hot after brewing by adjusting the time after the appliance automatically switches off. The default automatic switch-off time is 30 minutes. The maximum automatic switch-off time is 300 minutes.

To adjust the automatic switch-off time, follow the steps below:

- 1 Power off the appliance and keep it plugged.
- 2 Press and hold cleaning button until keep warm icon is shown and hour starts flash.
- 3 Follow step in "Setting the clock" to complete setting.

Flushing the appliance

Always flush the coffeemaker once before first use by following the steps below.

Warning: Never pour water into the bean container, as this damages the coffeemaker.

- 1 Open the water reservoir lid.

Caution: Do not put coffee beans or pre-ground coffee in the water reservoir

- 2 You can fill the water reservoir with water in either way below:

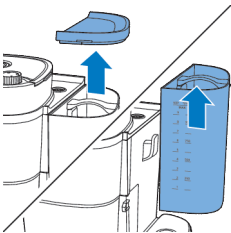



- Lift the tank from the appliance and place it under tap to fill in water.

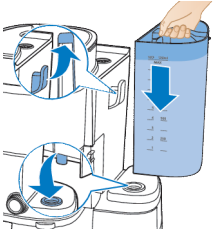

- Make sure the hook is attached properly when placing back.
- Grab the lid tab to pull up the jug lid. Place the coffee jug under tap to fill in water. Fill the water tank with coffee jug.
- Make sure the water is below maximum level.

3 Close the water reservoir lid.

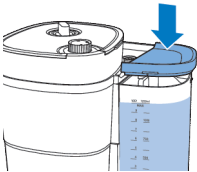

4 Put the coffee jug in the appliance.

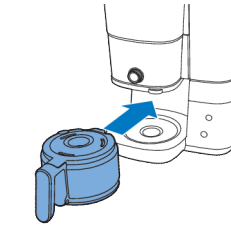

5 Rotate the central knob to jug setting.

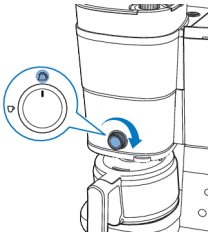



- 6 Press the on/off button.
- The appliance is powered on.



- 7 Press the coffee strength button and select pre-ground coffee.

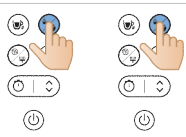

- 8 Press cup button and select 10 cups.



- 9 Press the start button.



- 10 The appliance starts the flushing process.
- 11 Let the appliance operate until the flushing process is finished.

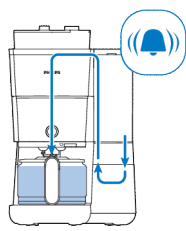



12 Empty the glass jug.

Using the appliance

Using coffee beans

Note: the coffee machine will use required amount of water based on no. of coffee cups to be prepared

Follow steps below to use:

1 Open the lid of the water reservoir and lift the tank from the appliance.

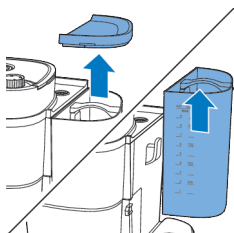

2 Fill the tank with water from the tap.

- Make sure that the water level is below the maximum level.



3 Place the tank back on the appliance.

- Make sure the hook is properly attached.

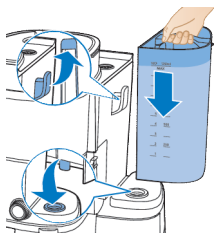

- 4 Close the lid of the water container.

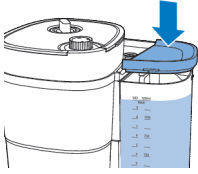

- 5 Lift the lid of bean container.

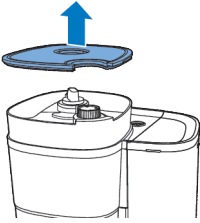

- 6 Add your desired coffee beans to the container.

Note: Always make sure that the fresh bean duo bean container is at least half full.

Warning: To prevent the grinder from jamming, do not use unroasted or caramelized beans. Use coffee beans instead of espresso beans, as espresso beans may damage the grinder.

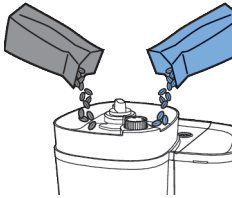

- 7 Close the lid of bean container.

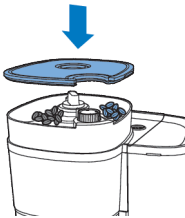

- 8 Turn the container selector knob to choose desired beans between the two containers.

- You can even mix two different types of beans for a unique blend.

Note: Whenever you switch between coffee bean containers or coffee beans, there will always be traces of coffee left of the previously ground type of coffee beans. Clean the grinder funnel after you switch to a new type of coffee bean to prevent this.

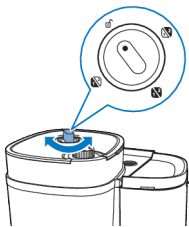

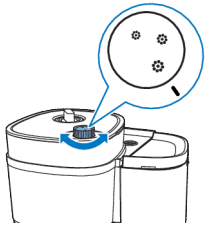

9 Choose your desired coarseness level by using the knob.

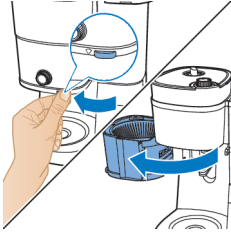

10 Grab the tab to open the filter holder.

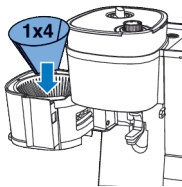

11 Place a paper filter (type 1x4 or no. 4) in the filter basket.

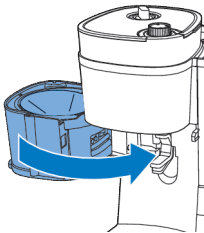

12 Close the filter holder

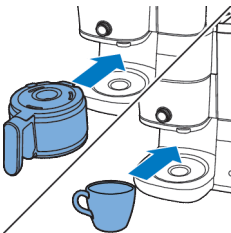

13 Place the coffee jug or your cup under the dispenser.

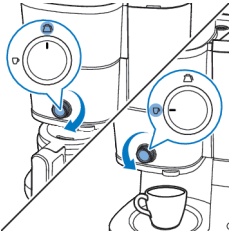

14 Use the knob to select the amount of coffee you want to make.

When using brew into cup function, you can use either glass or ceramic mugs, as well as glasses. Ensure that you use cups with less than 10 cm in height.

10 3

15 Power on the appliance.



16 Select the number of cups you want to make by pressing the cup button.



17 Press the strength button to choose your preferred coffee strength.

- 1: Bean for mild coffee
- 2: beans for medium strong coffee
- 3: beans for strong coffee



18 Start the process by pressing the start/pause button.



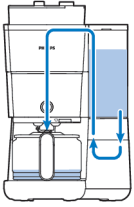

- 19** The appliance starts processing.
- The appliance will beep when it's done.

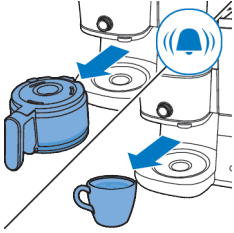

- 20** Remove your cup or the coffee jug from the appliance.

The drip stop function enables you to remove the jug from the coffeemaker before the brewing process is finished. When you remove the jug, the drip stop stops the flow of coffee into the jug.

The brewing process does not stop when you remove the jug. If you do not put the jug back into the appliance within 20 seconds, the filter basket overflows.



- 21** Enjoy your freshly brewed coffee.

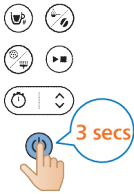

- 22** To turn off the appliance, press and hold the start/pause button for three seconds.

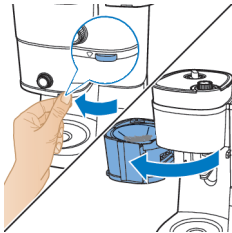

- 23** Open the filter holder.

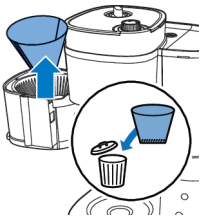

24 Remove the used paper filter.

The keep warm function does not activate when brewing one or two 2 cups.

Your appliance will keep your drink hot until it turns off automatically. If you don't want your drink to stay hot anymore, press the on/off button to turn off the appliance.

Using pre-ground coffee

Follow steps below to use:

- 1 Check that the appliance has enough water to make your desired amount of coffee.

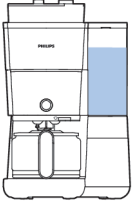

- 2 Grab the tab to open the filter holder.

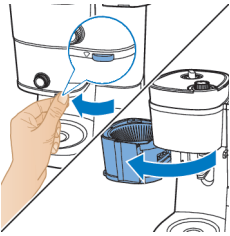

- 3 Place a paper filter (type 1x4 or no. 4) in the filter basket.

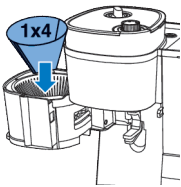

- 4 Add the amount of pre-ground coffee in the paper filter you use depends on personal preference.
 - For a standard cup of coffee, use 6 grams of ground coffee or 1 tablespoon.

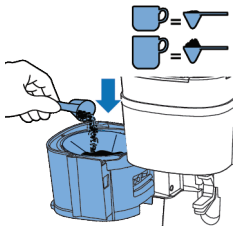

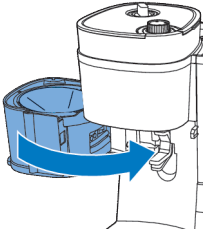

5 Close the filter holder.

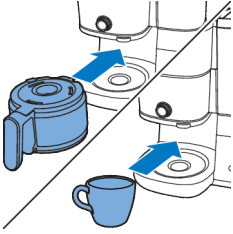

6 Place the coffee jug or your cup under the dispenser.

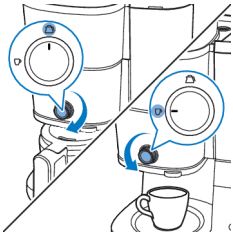

7 Use the knob to select the amount of coffee you want to make.



8 Power on the appliance.

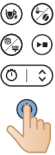

9 Choose to use pre-ground coffee by pressing the mode selection button.

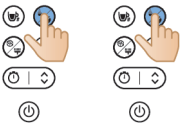



10 Select the number of cups you want to make by pressing the cup button.

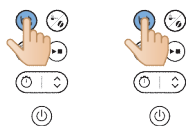

11 Start the process by pressing the start/pause button.



12 The appliance starts processing.
- The appliance will beep when it's done.

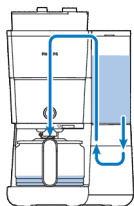

13 Remove your cup or the coffee jug from the appliance.

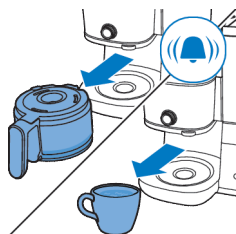

14 Enjoy your freshly brewed coffee.



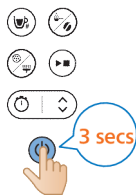

15 To turn off the appliance, press and hold the start/pause button for three seconds.

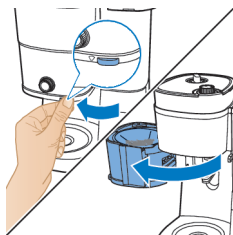

16 Open the filter holder.

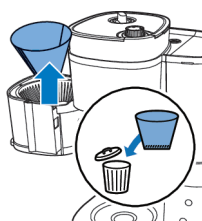

17 Remove the used paper filter.

Setting the timer

To set the timer on the appliance, follow these steps:

- 1** Turn on the coffee machine.
- 2** Press the timer button and the timer icon will appear on the display. The hour digits flash to indicate setting hour.

08:06 



08:00



- 3 Use the arrow button to adjust the hours. If you need to adjust quickly, long-press the arrow button.

08:



- 4 Press the timer button to confirm the hour setting. The minutes digits indicate setting minute.



08:05



- 5 Use the arrow button again to adjust the minutes. If you need to adjust quickly, long-press the arrow button.

08:06



- 6 Press the timer button again to confirm the minute setting.

To cancel the timer, simply press the timer button, and the timer icon will disappear from the display.



Cleaning and Maintenance

Cleaning after every use

Never immerse the coffee machine in water or any other liquid, nor rinse it under the tap.

1 Remove the mains plug from the wall socket.

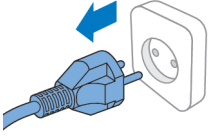







2 Wipe the outside of the coffee machine with a damp cloth.

3 Clean the filter basket with hot water and some washing-up liquid or clean them in the dishwasher.



4 Clean the coffee jug & lid to rinse under tap. Or clean them in the dishwasher.

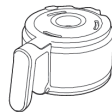
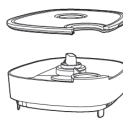

			
	✓	✓	✓
	✓	✓	✓
	✓	✓	✓
	✓	✗	✓
	✓	✗	✓

Cleaning the grinder funnel

Important:

Clean the grinder funnel every 1 to 2 weeks to prevent clogging with ground coffee. This is easily and quickly done by following the steps below.

Clean the grinder funnel when you notice there is a brush alert appeared on the display.

Note: Make sure the coffee bean container is empty before you start the cleaning procedure.

- 1 Plug in the appliance.

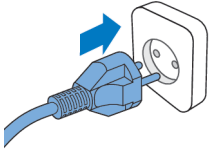

- 2 Open the filter holder to access the ground funnel chute.

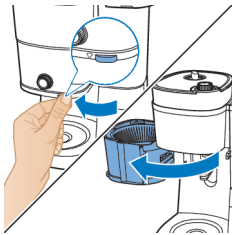

- 3 Turn on the coffee machine.

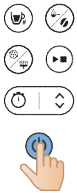

- 4 Press the clean button on the machine's control panel.
- 5 Select the brush setting on the display screen.





- 6 Press the start button. This will cause the ground funnel chute flap to open, allowing you to clean the chute with a brush.

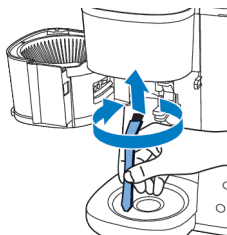

- 7 Use a brush to remove any coffee grounds or residue that may have accumulated in the chute.



- 8 After cleaning the chute, press the start button again to close the flap.

Descaling the coffee machine

Descalc the coffee machine when you notice there is a descaling alert appeared on the display. Only use white vinegar to descale, as other products may cause damage to the coffee machine.

Warning: Never use vinegar with an acetic acid content of 8 % or more, natural vinegar, powder descalers or tablet descalers to descale the machine, as this may cause damage.

- 1 Open the water reservoir lid.

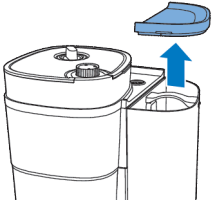

- 2 Fill the water reservoir with white vinegar (4 % acetic acid) up to the 10-cup indication.

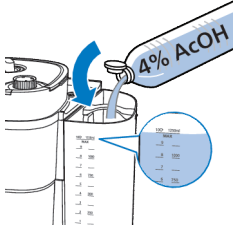

- 3 Close the lid of the water container.

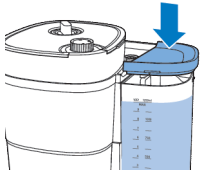

- 4 Grab the tab to open the filter holder.

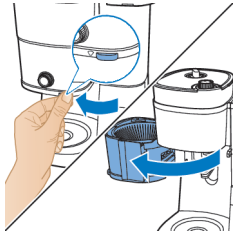

- 5 Place a paper filter (type 1x4 or no. 4) in the filter basket and close the filter basket holder.

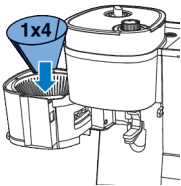

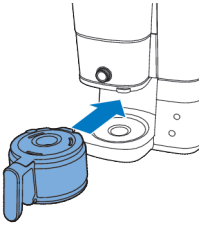

- 6 Put the empty jug in the coffee machine.
- 7 Put the mains plug in the wall socket.

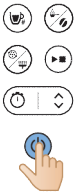

- 8 Press the power button to switch on the coffee machine. The display lights up.

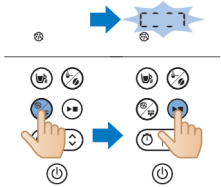

- 9 Press the cleaning button on the coffee machine.
- 10 Select the descaling setting.
- 11 Press the start button to confirm your selection.
 - The coffee machine will automatically begin the descaling process.

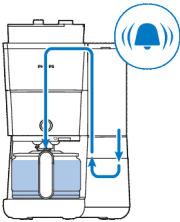

- 12 Wait for the machine to finish brewing the descaling solution.
- 13 Once the descaling process is complete, rinse the machine twice with the maximum amount of water to completely remove any deposits.

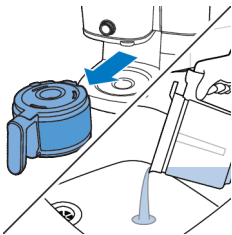

- 14 Empty the jug and remove the paper filter with the scale residues.
- 15 Fill the water reservoir with fresh cold water and press start button to start another brewing process.

Let the coffee machine complete the entire brewing process and empty the jug.

Note: If necessary, repeat step 14 until the water that comes out of the coffee machine no longer tastes or smells of vinegar.

- 16 Clean the filter basket and the jug with hot water and some washing-up liquid.
- 17 Press the power button to switch off the appliance.

Troubleshooting

This chapter summarizes the most common problems you could encounter with the machine. If you are unable to solve the problem with the information below, visit www.philips.com/support for a list of frequently asked questions or contact the Consumer Care Center in your country.

You can also scan this QR code for more online support.



Problem

Solution

The coffee machine does not work.

Put the mains plug in the wall socket and press the on/off button to switch on the coffee machine.

Make sure that the voltage indicated on the coffee machine corresponds to the local mains voltage.

Fill the water reservoir with water.

Close the lid of the grinder funnel.

The grinder does not work or does not work properly.

Make sure that you did not select pre-ground coffee. If the symbol for pre-ground coffee is visible on the display, you selected pre-ground coffee.

Clean the grinder funnel by following the instructions.

When I use the grinder, the coffee is too weak.

Turn the coarseness knob to select the desired type of grind from fine to coarse.

Use the strength select button to set the coffee strength from 1 to 3 , the larger digit means stronger strength.

Use coffee beans of a stronger blend or flavor.

When I use pre-ground coffee, the coffee is too weak.

Make sure that the amount of pre-ground coffee in the filter is consistent with the amount of water in the water reservoir. Please keep in mind that the coffee machine uses up all the water in the water reservoir.

Use ground coffee of a stronger blend or flavor.

To increase the coffee strength, increase the amount of pre-ground coffee or decrease the amount of water.

The filter overflows when I remove the jug from the coffee machine while it is brewing coffee.

If you remove the jug for more than 20 seconds during the brewing process, the drip stop causes the filter basket to overflow. Also note that the coffee does not reach its full taste before the end of the brewing process. Therefore we advise you not to remove the jug and pour out the coffee before the end of the brewing process.

The coffee machine continues to drip long after the brewing process has ended.	The dripping is caused by condensation of steam. It is completely normal that the coffee machine drips for some time.
Can't wait for the last few drops.	Switch the knob from cup to jug mode to open the drip stop function, drip stop will stop the dripping from the filter basket.
	If the dripping does not stop, the drip stop may be clogged. To clean the drip stop, open the filter basket holder and take out the filter basket. Rinse the filter basket and the drip stop under the tap.
The coffee is not hot enough.	The coffee in the jug cools down faster if you brew only a few cups. The coffee stays hot longer if you brew 10 cups, which is a full jug. Descalc the coffee machine.
The coffee beans seem to be used up quickly.	To brew a perfect cup of coffee, the coffee machine needs a certain amount of ground coffee. The amount of coffee beans the coffee machine uses to obtain the optimal amount of ground coffee per cup is normal.
The timer does not work.	Make sure you complete all steps for brewing coffee with coffee beans or pre-ground coffee before you set the timer.

Error code

Error code	Description	Solution	Remark
E1	Water shortage	Press any button to put the appliance on standby mode. Refill the water tank and restart the appliance.	If this problem persists, follow these steps: Press and hold the cleaning and start button simultaneously for three seconds, until the appliance automatically starts pumping water for one minute. Repeat this process 3 times. Contact customer service if the problem still persists.
E2	Bean container unavailable	Press any button to put the appliance on standby mode. Attach bean container securely and restart the appliance	Contact customer service if the problem persists.
E3	Heating tube malfunctioning	Unplug the appliance. Plug and power on the appliance again until it is cooled down completely.	Contact customer service if the problem persists.

E4	Grinding wheel blockage	Unplug the appliance. Plug and power on the appliance again. Follow steps in "Cleaning the grinder funnel" to clean grinding wheel and ground funnel chute.	Contact customer service if the problem persists.
E5	Ground funnel chute blockage	Unplug the appliance. Plug and power on the appliance again. Follow steps in "Cleaning the grinder funnel" to clean ground funnel chute.	Contact customer service if the problem persists.
E6/E7/ E8	Program error	Unplug the appliance. Plug and power on the appliance again.	Contact customer service if the problem persists.

Úvod

Gratuluje k nákupu a vítáme vás mezi uživateli výrobků společnosti Philips!
Chcete-li plně využívat výhod, které nabízí podpora společnosti Philips, zaregistrujte svůj výrobek na adrese www.philips.com/welcome.

Všeobecný popis

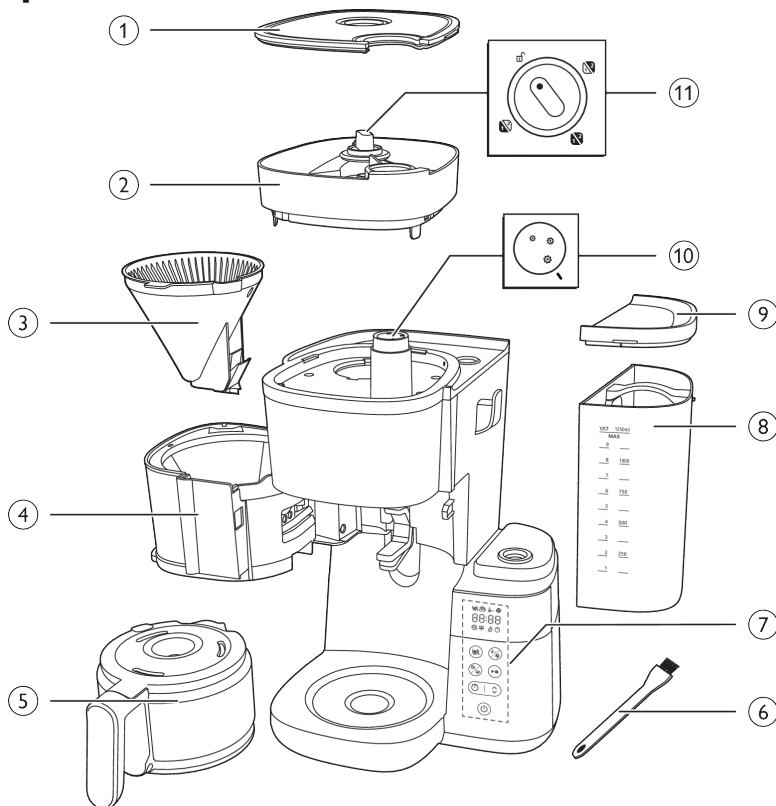

- 1 Víko nádoby na kávová zrna
- 2 Nádobka na kávová zrna
- 3 Košík filtru
- 4 Držák košíku filtru
- 5 Skleněná konvice
- 6 Kartáček na čištění žlábků na kávová zrna
- 7 Ovládací panel s displejem
- 8 Nádržka na vodu
- 9 Víko nádržky na vodu
- 10 Knoflík hrubosti
- 11 Knoflík pro výběr nádoby

Ovládací panel



Tlačítko zapnutí/vypnutí



Tlačítko časovače a tlačítko se šipkou pro nastavení času



Tlačítko pro spuštění/pozastavení



Tlačítko čištění



Tlačítko mleté kávy a intenzity kávy



Tlačítko pro výběr šálku

Ikona na displeji



Počet šálků



Režim uchování teploty



Mletá káva



Intenzita kávy



Odstraňování vodního kamene



Upozornění na ruční vyčištění



Rezervace nízké hladiny vody



Časovač

**Časový displej**

První dvě číslice představují hodiny a poslední dvě číslice minuty.



Otočte knoflíkem do odemykačí polohy, poté můžete z přístroje vyjmout nádobu na kávová zrna.



Tímto knoflíkem se volí hrubost kávy, přičemž větší velikost znamená hrubší zpracování.

**Režim konvice**

V režimu konvice existuje funkce proti odkapávání.

Poznámka: Proces přípravy kávy se nezastaví, když vyjmete konvici. Pokud konvicí nevložíte zpět do přístroje do 20 sekund, dojde k přetečení košíku filtru.

**Režim šálku**

Ručním přepnutím knoflíku z režimu šálku do režimu konvice otevřete uzávěr odkapávání, abyste zabránili odkapávání po dokončení cyklu přípravy kávy

Poznámka: Studený keramický šálek při zahřívání odvádí teplo z kávy. Předehřejte šálek horkou vodou.

Důležité informace

Varování

- Dříve než přístroj připojíte do sítě, zkontrolujte, zda napětí uvedené na přístroji souhlasí s napětím v místní elektrické síti.
- Přístroj připojujte do řádně uzemněných zásuvek.
- Pokud byste zjistili závadu na zástrčce, na napájecím kabelu nebo na přístroji, dále jej nepoužívejte.
- Pokud by byl poškozen napájecí kabel, musí jeho výměnu provést společnost Philips, autorizovaný servis společnosti Philips nebo obdobně kvalifikovaní pracovníci, aby se předešlo možnému nebezpečí.
- Děti od 8 let věku a osoby s omezenými fyzickými, smyslovými nebo duševními schopnostmi nebo nedostatkem zkušeností a znalostí mohou tento přístroj používat v případě, že jsou pod dohledem nebo byly poučeny o bezpečném používání přístroje a že chápou rizika, která mohou hrozit. Čištění a údržbu by neměly provádět děti, které jsou mladší než 8 let a jsou bez dozoru. Přístroj a jeho kabel udržujte mimo dosah dětí mladších 8 let.
- Děti si s přístrojem nesmí hrát.
- Nenechávejte přírodní kabel viset přes hranu stolu nebo pracovní desky, na které je přístroj postaven.
- Tento přístroj používejte pouze k určenému účelu, abyste předešli možnému nebezpečí nebo zranění.

Upozornění

- Před prvním použitím přístroj vždy vypláchněte čerstvou vodou.
- Nepokládejte přístroj na horký povrch a dbejte také na to, aby síťový kabel nepřišel do styku s horkými povrchy.
- Přístroj neumísťujte do skříně, pokud je v provozu.
- Před čištěním nebo pokud se vyskytnou během přípravy kávy problémy, přístroj odpojte.
- Přístroj čistěte vždy až po jeho vychladnutí.
- Během přípravy kávy a udržování teploty jsou nádržka na vodu, držák filtru, plotýnka, spodní část přístroje a konvice naplněná kávou horké ještě nějakou dobu poté.
- Nepokládejte konvici na sporák ani do mikrovlnné trouby, abyste kávu znovu ohřáli.
- Tento přístroj je určen pro použití v domácnostech a podobných prostředích, jako jsou farmy, prostředí pro nocleh a snídaně, kuchyně pro personál v obchodech, kancelářích a jiných pracovištích a pro klienty v hotelech, motelech a dalších obytných prostředích.
- Kontrolu nebo opravu přístroje svěťte vždy servisu společnosti Philips. Přístroj neotevírejte a nepokoušejte se jej sami opravovat.
- Povrch topného tělesa, držák filtru, spodní část přístroje, plotýnka a konvice naplněná kávou jsou vystaveny zbytkovému teplu ještě nějakou dobu po použití.
- Pokud není uvedeno jinak, veškerý obalový materiál v balení je vyroben z recyklovaného papíru. Přečtěte si marketingový text PAP na krabici.

Odstraňování vodního kamene

- Odstraňte vodní kámen z kávovaru, jakmile zjistíte, že se na displeji objevilo upozornění na odstranění vodního kamene. K odstranění vodního kamene použijte pouze bílý ocet, protože jiné přípravky mohou způsobit poškození přístroje.

Elektromagnetická pole (EMP)

Tento přístroj společnosti Philips odpovídá normám týkajícím se elektromagnetických polí (EMP).

Recyklace



Tento symbol znamená, že výrobek nelze likvidovat s běžným komunálním odpadem (2012/19/EU).

Řiďte se pravidly vaší země pro sběr elektrických a elektronických výrobků. Správnou likvidací pomůžete předejít negativním dopadům na životní prostředí a lidské zdraví.

Pokud není uvedeno jinak, veškerý obalový materiál v balení je vyroben z recyklovaného papíru. Přečtěte si marketingový text PAP na krabici.

Záruka a podpora

Versuni nabízí po zakoupení tohoto výrobku dvouletou záruku. Tato záruka se nevztahuje na poškození vzniklé v důsledku nesprávného použití nebo špatné údržby přístroje. Naše záruka nemá vliv na vaše zákaznická práva. Více informací a způsob, jak uplatnit záruku, naleznete na stránkách www.philips.com/support.

Před prvním použitím

Po každém použití se ujistěte, že jste vyčistili držák filtru a trvalý filtr.

Po každém použití držák filtru důkladně otřete suchým hadříkem. Ujistěte se, že jej vyčistíte od nahromaděného kondenzátu.

Nastavení hodin

- 1 Přístroj připojte do sítě.
 - Displej hodin začne blikat.

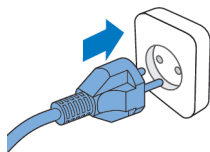

08:00



- 2 Pomocí tlačítka se šipkou nastavte hodinu.

08:



- 3 Jakmile hodinu nastavíte, stisknutím tlačítka časovače ji potvrďte.



09:06



4 Začne blikat ukazatel minut. Pomocí tlačítka se šipkou nastavte minuty.

08:06



5 Stisknutím tlačítka časovače nastavené minuty potvrďte.



08:06

- Aktuální čas je nyní nastaven a uložen.

6 Pro nastavení časovače v pohotovostním režimu můžete zvolit jeden ze dvou níže uvedených přístupů:

- Vypojte přístroj ze zásuvky a znovu jej zapojte.
- Stiskněte a podržte tlačítko časovače, dokud nezačnou blikat číslice hodin.

Poznámka

Přístroj vždy uloží poslední nastavení.

Doba uchování teploty

Nastavením doby po automatickém vypnutí přístroje můžete zvolit, jak dlouho má káva po přípravě zůstat horká. Výchozí doba automatického vypnutí je 30 minut. Maximální doba automatického vypnutí je 300 minut.

Chcete-li nastavit dobu automatického vypnutí, postupujte podle následujících kroků:

- 1 Vypněte přístroj a nechte jej připojený k síti.
- 2 Stiskněte a podržte tlačítko čištění, dokud se nezobrazí ikona uchování teploty a nezačnou blikat hodiny.
- 3 Pro dokončení nastavení postupujte podle kroku v části „Nastavení hodin“.

Vypláchnutí přístroje

Kávovar vždy jednou vypláchněte před prvním použitím podle níže uvedených kroků.

Upozornění: Nikdy nelijte vodu do nádoby na kávová zrna, protože by došlo k poškození kávovaru.

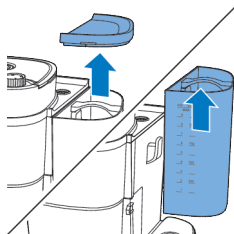

1 Otevřete víko nádržky na vodu.

Upozornění: Do nádržky na vodu nevkládejte zrnkovou ani mletou kávu

2 Nádržku na vodu můžete naplnit vodou oběma níže uvedenými způsoby:



- Zvedněte nádržku ze přístroje a pod vodovodním kohoutkem ji naplňte vodou.

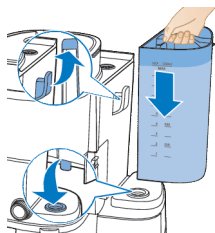

- Při zpětném vkládání se ujistěte, že je háček správně připevněn.
- Uchopením za jazýček víka vytáhněte víko konvice nahoru. Konvici na kávu naplňte pod vodovodním kohoutkem vodou. Naplňte nádržku na vodu konvicí na kávu.
- Ujistěte se, že je voda pod maximální hladinou.

3 Zavřete víko nádržky na vodu.

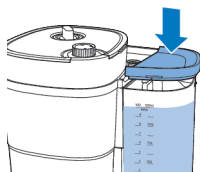

4 Vložte konvici na kávu do přístroje.

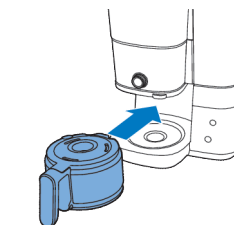

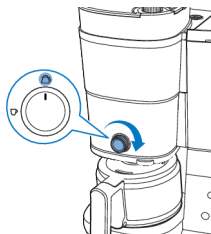

5 Otočte středovým knoflíkem na nastavení konvice.

☕ ☕
10 3

6 Stiskněte vypínač přístroje.

- Přístroj je zapnutý.



7 Stiskněte tlačítko intenzity kávy a zvolte mletou kávu.

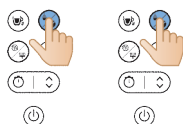

8 Stiskněte tlačítko šálku a zvolte 10 šálků.

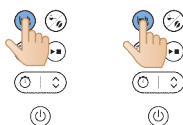

9 Stiskněte tlačítko start.



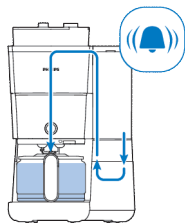

10 Přístroj zahájí proces proplachování.

11 Nechte přístroj pracovat, dokud není proces proplachování dokončen.



12 Vyprázdněte skleněnou konvici.

Použití přístroje

Použití kávových zrn

Poznámka: kávovar použije potřebné množství vody podle počtu připravovaných šálek kávy

Podle následujících pokynů proveďte následující:

1 Otevřete víko nádržky na vodu a nádržku z přístroje vyjměte.

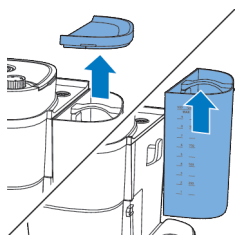

2 Naplňte nádržku vodou z vodovodního kohoutku.

- Ujistěte se, že hladina vody je pod maximální úrovní.



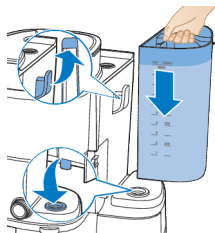

- 3 Umístěte nádržku zpět do přístroje.
- Ujistěte se, že je háček řádně připraven.

- 4 Zavřete víko nádržky na vodu.

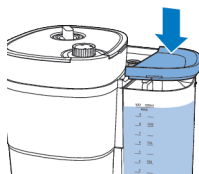

- 5 Zvedněte víko nádoby na kávová zrna.

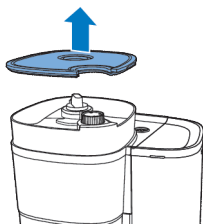

- 6 Do nádoby přidejte požadovaná kávová zrna.

Poznámka: Vždy se ujistěte, že je dvojitá nádoba na čerstvá kávová zrna plná alespoň z poloviny.

Upozornění: Aby se mlýnek nezasekával, nepoužívejte nepražená nebo karamelizovaná kávová zrna. Místo zrnkové kávy na espresso používejte kávová zrna, protože zrnková káva na espresso může mlýnek poškodit.

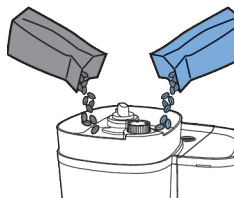

- 7 Zavřete víko nádoby na kávová zrna.

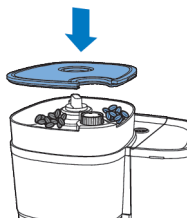

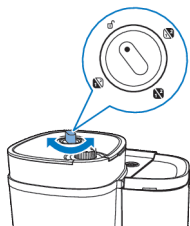

- 8** Otáčením knoflíku pro výběr nádoby vyberte požadovaná kávová zrna z jedné nebo druhé nádoby.
- Můžete dokonce smíchat dva různé druhy kávových zrn a vytvořit tak jedinečnou směs.

Poznámka: Při každém přepnutí mezi nádobami na zrnkovou kávu nebo kávovými zrny vždy zůstanou stopy kávy z dříve namletého druhu kávových zrn. Po přechodu na nový typ zrnkové kávy vyčistěte násypku mlýnku, abyste tomu zabránili.

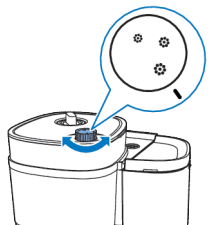

- 9** Pomocí knoflíku zvolte požadovaný stupeň hrubosti.

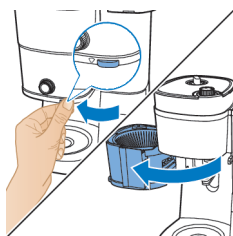

- 10** Uchopením za jazýček otevřete držák filtru.

- 11** Do košíku filtru vložte papírový filtr (typ 1x4 nebo č. 4).

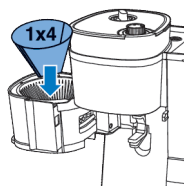

- 12** Držák filtru uzavřete

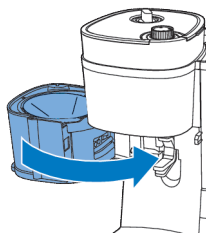

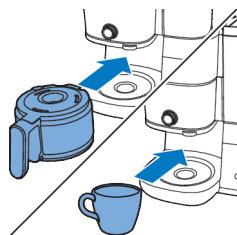

13 Pod dávkovač umístěte konvici na kávu nebo svůj šálek.

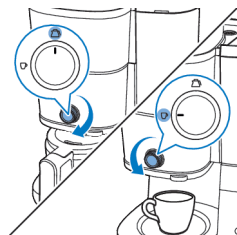

14 Pomocí knoflíku zvolte množství kávy, které chcete připravit.

Při použití funkce přípravy do šálku můžete použít i skleněné nebo keramické hrnky a sklenice. Ujistěte se, že používáte šálky s výškou menší než 10 cm.

W 3

15 Zapněte přístroj.



W 3

16 Stisknutím tlačítka šálku zvolte počet šálek, které chcete připravit.



W 2

17 Stisknutím tlačítka intenzity kávy zvolte požadovanou intenzitu kávy.

- 1: Zrna pro slabou kávu
- 2: zrna pro středně silnou kávu
- 3: zrna pro silnou kávu





18 Spusťte přípravu stisknutím tlačítka spuštění/pozastavení.

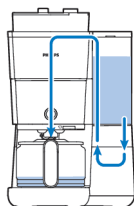

19 Příklad zahájí přípravu.

- Příklad vydá zvukový signál, když je hotový.

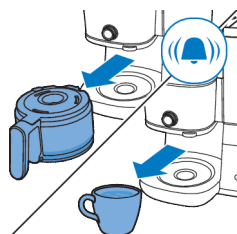

20 Vyměňte šálek nebo konvici na kávu z přístroje.

Funkce proti odkapávání umožňuje vyjmout konvici z kávovaru před dokončením procesu přípravy kávy. Po vyjmutí konvice zastaví funkce proti odkapávání odtékání kávy do konvice.

Proces přípravy kávy se nezastaví, když vyjmete konvici. Pokud konvici nevložíte zpět do přístroje do 20 sekund, dojde k přetečení košíku filtru.



21 Vychutnejte si čerstvě připravenou kávu.



22 Chcete-li přístroj vypnout, stiskněte a podržte tlačítko spuštění/pozastavení po dobu tří sekund.

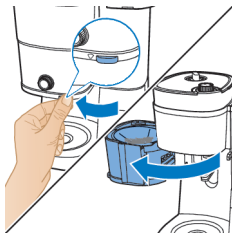

23 Otevřete držák filtru.

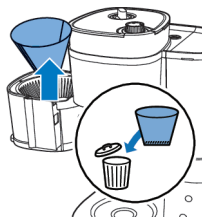

24 Vyměňte použitý papírový filtr.

Funkce uchování teploty se neaktivuje při přípravě jednoho nebo dvou šáleků.

Přístroj bude udržovat nápoj teplý, dokud se automaticky nevypne. Pokud již nechcete, aby nápoj zůstal horký, vypněte přístroj stisknutím vypínače.

Použití mleté kávy

Podle následujících pokynů proveďte následující:

- 1** Zkontrolujte, zda je v přístroji dostatek vody pro přípravu požadovaného množství kávy.

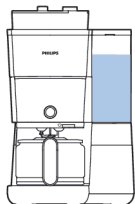

- 2** Uchopením za jazýček otevřete držák filtru.

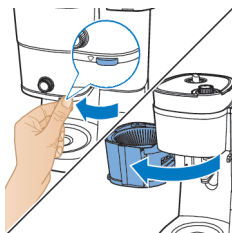

- 3** Do košíku filtru vložte papírový filtr (typ 1x4 nebo č. 4).

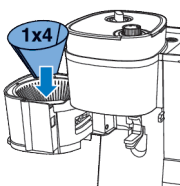

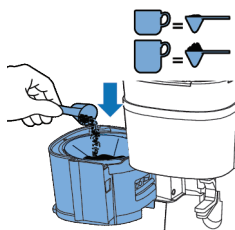

- 4** Množství mleté kávy v použitém papírovém filtru závisí na osobních preferencích.
- Pro standardní šálek kávy použijte 6 gramů mleté kávy nebo 1 polévkovou lžičku.

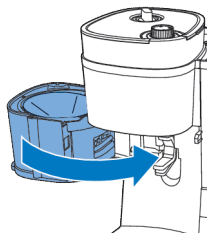

- 5** Držák filtru uzavřete.

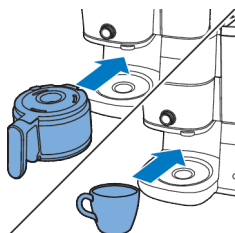

- 6** Pod dávkovač umístěte konvici na kávu nebo svůj šálek.

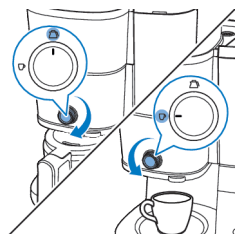

- 7** Pomocí knoflíku zvolte množství kávy, které chcete připravit.

WS 10 3

- 8** Zapněte přístroj.





9 Stisknutím tlačítka volby režimu zvolte použití mleté kávy.



10 Stisknutím tlačítka šálku zvolte počet šálek, které chcete připravit.

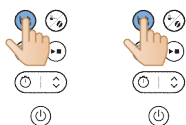

11 Spusťte přípravu stisknutím tlačítka spuštění/pozastavení.



12 Příklad zahájí přípravu.

- Příklad vydá zvukový signál, když je hotový.

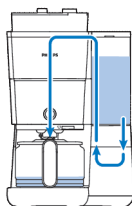

13 Vyměňte šálek nebo konvici na kávu z přístroje.

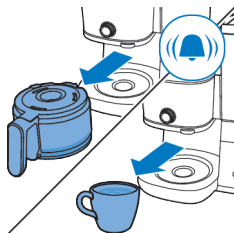



14 Vychutnejte si čerstvě připravenou kávu.

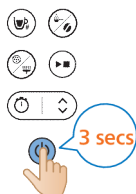

15 Chcete-li přístroj vypnout, stiskněte a podržte tlačítko spuštění/pozastavení po dobu tří sekund.

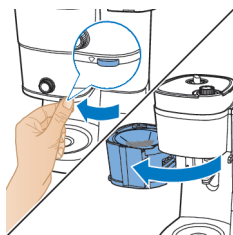

16 Otevřete držák filtru.

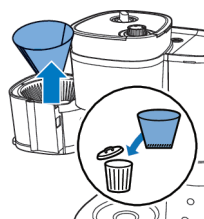

17 Vyjměte použitý papírový filtr.

Nastavení časovače

Chcete-li na přístroji nastavit časovač, postupujte podle následujících kroků:

1 Zapněte kávovar.

08:05



- 2 Stiskněte tlačítko časovače a na displeji se zobrazí ikona časovače. Číslice hodin blikají a ukazují hodinu nastavení.



08:00

- 3 Pomocí tlačítka se šipkou nastavte hodiny. Pokud potřebujete nastavení provést rychle, dlouze stiskněte tlačítko se šipkou.



08:



- 4 Potvrďte nastavenou hodinu stisknutím tlačítka časovače. Číslice minut indikují nastavení minut.



08:05

- 5 Pomocí tlačítka se šipkou opět nastavte minuty. Pokud potřebujete nastavení provést rychle, dlouze stiskněte tlačítko se šipkou.



08:05



- 6 Potvrďte nastavenou minutu opětovným stisknutím tlačítka časovače. *Chcete-li časovač zrušit, jednoduše stiskněte tlačítko časovače a ikona časovače z displeje zmizí.*

Funkce proti odkapávání umožňuje vyjmout konvici z kávovaru před dokončením procesu přípravy kávy. Po vyjmutí konvice zastaví funkce proti odkapávání odtékání kávy do konvice.



Poznámka: Proces přípravy kávy se nezastaví, když vyjmete konvici. Pokud konvici nevložíte zpět do přístroje do 20 sekund, dojde k přetečení košíku filtru.

Čištění a údržba

Čištění po každém použití

Kávovar nikdy neponořujte do vody nebo jiné kapaliny ani jej neproplachujte pod tekoucí vodou.

- 1 Odpojte síťovou zástrčku od zásuvky ve zdi.

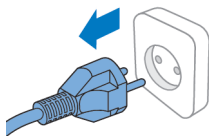





- 2 Otřete vnější povrch kávovaru navlhčeným hadříkem.
- 3 Košík filtru umyjte v horké vodě s přidavkem mycího prostředku nebo jej umyjte v myčce nádobí.



- 4 Vyčistěte konvici na kávu a víko, které opláchněte pod vodovodním kohoutkem. Nebo je umyjte v myčce nádobí.

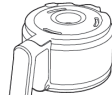
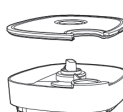
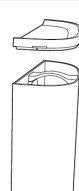

			
	✓	✓	✓
	✓	✓	✓
	✓	✓	✓
	✓	✗	✓
	✓	✗	✓

Čištění násypky mlýnku

Důležité informace:

Násypku mlýnku čistěte každé 1 až 2 týdny, abyste zabránili jeho ucpání mletou kávou. To lze snadno a rychle provést podle níže uvedených kroků.

Násypku mlýnku vyčistěte, jakmile si všimnete, že se na displeji objevilo upozornění kartáčku.

Poznámka: Před zahájením čištění se ujistěte, že je nádoba na kávová zrna prázdná.

1 Přístroj připojte do sítě.

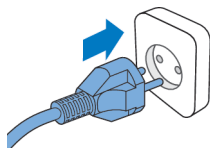

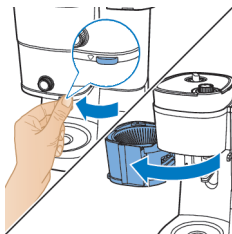

2 Otevřete držák filtru, abyste získali přístup k žlábků násypky na mletou kávu.

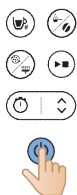

3 Zapněte kávovar.

4 Stiskněte tlačítko čištění na ovládacím panelu přístroje.

5 Na displeji zvolte nastavení kartáčku.

☰



⏻

6 Stiskněte tlačítko start. Tím se otevře klapka žlábků násypky mlýnku, což vám umožní vyčistit žlábek kartáčkem.



☰



⏻

7 Kartáčkem odstraňte kávovou sedlinu nebo zbytky, které se mohly v žlábků nahromadit.

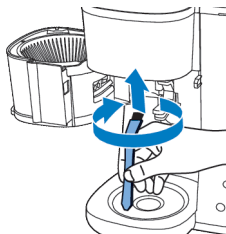



- 8 Po vyčištění žlábků znovu stiskněte tlačítko spuštění, čímž klapku zavřete.

Odstraňování vodního kamene z kávovaru

Odstraňte vodní kámen z kávovaru, jakmile zjistíte, že se na displeji objevilo upozornění na odstranění vodního kamene. K odstranění vodního kamene používejte pouze bílý ocet, protože jiné přípravky mohou kávovar poškodit.

Upozornění: K odstraňování vodního kamene z přístroje nikdy nepoužívejte ocet s obsahem kyseliny octové 8 % nebo více, přírodní ocet, práškové prostředky na odstraňování vodního kamene nebo tablety, protože by mohlo dojít k poškození.

- 1 Otevřete víko nádržky na vodu.

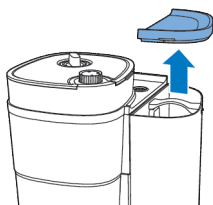

- 2 Naplňte nádržku na vodu bílým octem (4% kyselina octová) až po indikaci 10 šálek.

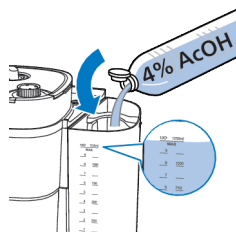

3 Zavřete víko nádržky na vodu.

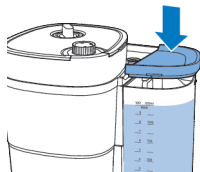

4 Uchopením za jazýček otevřete držák filtru.

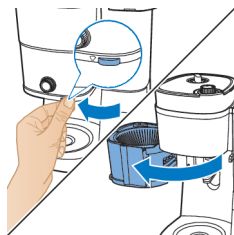

5 Do košíku filtru vložte papírový filtr (typ 1x4 nebo č. 4) a zavřete držák košíku filtru.

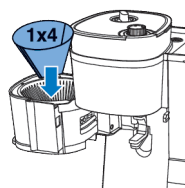

6 Vložte prázdnou konvici do kávovaru.

7 Zapojte zástrčku do zásuvky.

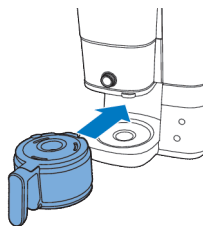

8 Stiskněte tlačítko napájení a kávovar zapněte. Rozsvítí se displej.

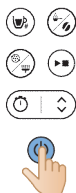

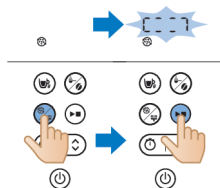

- 9 Stiskněte tlačítko čištění na kávovaru.
- 10 Zvolte nastavení pro odstranění vodního kamene.
- 11 Stisknutím tlačítka spuštění výběr potvrďte.
 - Kávovar automaticky zahájí proces odstraňování vodního kamene.

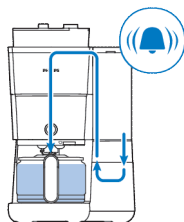

- 12 Počkejte, až kávovar dokončí přípravu roztoku na odstraňování vodního kamene.
- 13 Po dokončení procesu odstraňování vodního kamene kávovar dvakrát propláchněte maximálním množstvím vody, abyste zcela odstranili veškeré usazeniny.

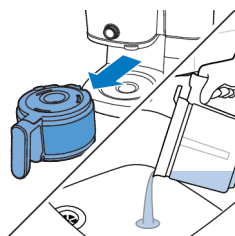

- 14 Vyprázdněte konvici a vyjměte papírový filtr se zbytky vodního kamene.
- 15 Naplňte nádržku na vodu čerstvou studenou vodou a stisknutím tlačítka spuštění zahajte další proces přípravy.
 - Nechte kávovar dokončit celý proces přípravy a vyprázdněte konvici.

Poznámka: V případě potřeby opakujte krok 14, dokud voda vycházející z kávovaru, nepřestane chutnat nebo vonět po octu.

- 16 Košík filtru a konvici umyjte v horké vodě s přídatkem mycího prostředku.
- 17 Stiskněte tlačítko napájení a přístroj vypněte.

Řešení problémů

V této kapitole najdete nejběžnější problémy, s nimiž se můžete u přístroje setkat. Pokud se vám nepodaří problém vyřešit s pomocí následujících informací, navštivte webové stránky www.philips.com/support, kde naleznete seznam nejčastějších dotazů, nebo se obraťte na středisko péče o zákazníky ve své zemi. Můžete také naskenovat tento QR kód pro další online podporu.



Problém

Řešení

Kávovar nefunguje.

Zasuňte napájecí zástrčku do síťové zásuvky a stisknutím tlačítka pro zapnutí/vypnutí kávovar zapněte.

Ujistěte se, že napětí uvedené na kávovaru odpovídá napětí v místní elektrické síti.

Naplňte vodou nádržku na vodu.

Zavřete víko násypky mlýnku.

Mlýnek nefunguje nebo nefunguje správně.

Ujistěte se, že jste nezvolili mletou kávu. Pokud je na displeji viditelný symbol mleté kávy, zvolili jste mletou kávu.

Vyčistěte násypku mlýnku podle pokynů.

Při použití mlýnku je káva příliš slabá.

Otáčením knoflíku hrubosti zvolte požadovaný typ mletí od jemného po hrubé.

Pomocí tlačítka volby intenzity kávy nastavte intenzitu kávy od 1 do 3, kdy větší číslce znamená silnější intenzitu.

Použijte kávová zrna výraznější odrůdy nebo výraznější chuti.

Při použití mleté kávy je káva příliš slabá.

Ujistěte se, že množství mleté kávy ve filtru odpovídá množství vody v nádržce na vodu. Mějte na paměti, že kávovar spotřebuje veškerou vodu v nádržce na vodu.

Použijte mletou kávu výraznější odrůdy nebo výraznější chuti.

Chcete-li mít silnější kávu, použijte větší množství mleté kávy nebo méně vody.

Filtr přetéká, když vyndám konvici z kávovaru během přípravy kávy.

Jestliže během přípravy kávy vyjmete konvici na dobu delší než 20 sekund, uzávěr odkapávání způsobí přetečení košíku filtru. Všimněte si také, že káva nedosáhne své plné chuti před koncem procesu její přípravy. Proto doporučujeme nevyjímat konvici a nevlévat kávu před koncem procesu přípravy.

Kávovar pokračuje v překapávání ještě dlouho po ukončení procesu přípravy.

Odkapávání je způsobeno kondenzací páry. Je zcela normální, že kávovar nějakou dobu odkapává.

Nemůže čekat na posledních pár kapek.

Přepnutím knoflíku z režimu šálku do režimu konvice otevřete funkci proti odkapávání, uzávěr odkapávání pak zastaví odkapávání z košíku filtru.

Pokud odkapávání nepřestává, může být ucpaný uzávěr odkapávání. Chcete-li vyčistit uzávěr odkapávání, otevřete držák košíku filtru a vyjměte košík filtru. Opláchněte košík filtru a uzávěr odkapávání pod vodovodním kohoutkem.

Káva není dostatečně teplá.

Káva v konvici vychladne rychleji, pokud připravíte jen několik šálků. Káva zůstane déle horká, pokud připravíte 10 šálků, což je plná konvice.

Odstraňte z kávovaru vodní kámen.

Zdá se, že se kávová zrna rychle spotřebovávají.

Aby kávovar připravil dokonalý šálek kávy, potřebuje určité množství mleté kávy. Množství kávových zrn, které kávovar používá k získání optimálního množství mleté kávy na šálek, je normální.

Časovač nefunguje.

Před nastavením časovače se ujistěte, že jste dokončili všechny kroky pro přípravu kávy za použití zrnkové nebo mleté kávy.

Chybový kód

Chybový kód	Popis	Řešení	Poznámka
E1	Nedostatek vody	Stisknutím libovolného tlačítka přepněte přístroj do pohotovostního režimu. Doplňte nádržku na vodu a přístroj znovu spusťte.	Pokud problém přetrvává, postupujte podle následujících kroků: Stiskněte a podržte současně tlačítko čištění a tlačítko spuštění po dobu tří sekund, dokud přístroj automaticky nezačne čerpat vodu po dobu jedné minuty. Tento postup opakujte třikrát. Pokud problém stále přetrvává, kontaktujte zákaznický servis.
E2	Nádoba na kávová zrna není k dispozici	Stisknutím libovolného tlačítka přepněte přístroj do pohotovostního režimu. Pevně připojte nádobu na kávová zrna a restartujte přístroj	Pokud problém přetrvává, kontaktujte zákaznický servis.
E3	Nefunkční topná trubice	Odpojte přístroj z napájení. Spotřebič znovu zapojte a zapněte, dokud zcela nevychladne.	Pokud problém přetrvává, kontaktujte zákaznický servis.
E4	Ucpání mlecího kotouče	Odpojte přístroj z napájení. Spotřebič znovu zapojte a zapněte. Podle pokynů v části „Čištění násypky mlýnku“ vyčistěte mlecí kotouč a žlábek násypky mlýnku.	Pokud problém přetrvává, kontaktujte zákaznický servis.
E5	Ucpaný žlábek násypky mlýnku	Odpojte přístroj z napájení. Spotřebič znovu zapojte a zapněte. Podle pokynů v části „Čištění násypky mlýnku“ vyčistěte žlábek násypky mlýnku.	Pokud problém přetrvává, kontaktujte zákaznický servis.
E6/E7/E8	Chyba programu	Odpojte přístroj z napájení. Spotřebič znovu zapojte a zapněte.	Pokud problém přetrvává, kontaktujte zákaznický servis.

Indledning

Tillykke med dit køb, og velkommen til Philips!

Hvis du vil have fuldt udbytte af den support, som Philips tilbyder, kan du registrere dit produkt på www.philips.com/welcome.

Generel beskrivelse

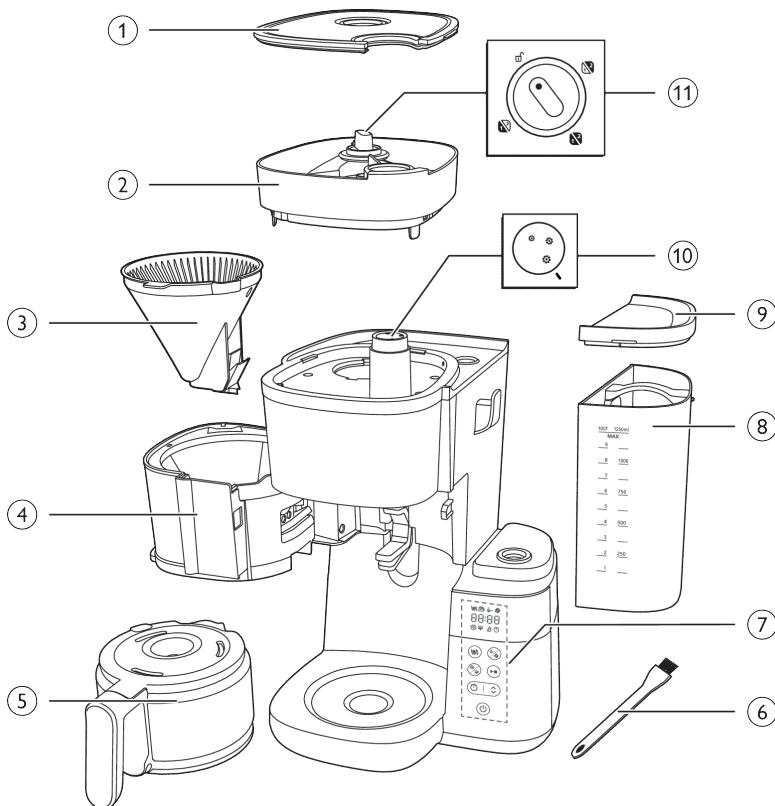

- 1 Låg til beholder til bønner
- 2 Hvide keramikkopper
- 3 Filterkurv
- 4 Holder til filterkurv
- 5 Glaskande
- 6 Rengøringsbørste til bønneslisken
- 7 Betjeningspanel med display
- 8 Vandtank
- 9 Låg til vandtank
- 10 Knap til formalingsgrad
- 11 Valgknap til beholder

Kontrolpanel



Tænd/sluk-knap



Timerknap og piletast til tidsjustering



Start/pause-knap



Rengøringsknap



Knap til formaling-og kaffestyrke



Knap til valg af kop

Skærmikon



Antal kopper



Hold varm-tilstand



Formalet kaffe



Kaffestyrke



Afkalkning



Manuel rengøring-alarm



Angivelse af lavt vandniveau



Timer



Tidsdisplay

De første to cifre viser timerne, og de sidste to cifre viser minutterne.



Drej knappen for at låse op, så kan du fjerne bønnebeholderen fra apparatet.



Med denne knap vælges kaffens formalingsgrad, hvor større størrelse angiver grovere formaling.



Kandetilstand

Drypstopfunktionen findes i kandetilstand.

Bemærk: Bryggeprocessen stopper ikke, når du fjerner kanden. Hvis du ikke sætter kanden tilbage i apparatet inden for 20 sekunder, flyder filterkurven over.



Koptilstand

Skift manuelt knappen fra kop- til kandetilstand for at åbne drypstoppet for at forhindre dryp, når bryggecyklussen er færdig

Bemærk: Et koldt keramisk krus vil afkøle kaffen, da det varmer sig selv op, anvend derfor en kop, der er forvarmet med varmt vand.

Vigtigt

Advarsel

- Kontroller, om den angivne netspænding på apparatet svarer til den lokale netspænding, før du slutter strøm til apparatet.
- Apparatet skal sluttes til en stikkontakt med jordforbindelse.
- Brug aldrig apparatet, hvis netstik, netledning eller selve apparatet er beskadiget.
- Hvis netledningen beskadiges, må den kun udskiftes af Philips, et autoriseret Philips-serviceværksted eller en tilsvarende kvalificeret fagmand for at undgå enhver risiko.
- Dette apparat kan bruges af børn fra 8 år og opefter og personer med reducerede fysiske, sensoriske eller mentale evner eller manglende erfaring og viden, hvis de er blevet instrueret i sikker brug af apparatet og forstår de medfølgende risici. Rengøring og vedligeholdelse må ikke foretages af børn, medmindre de er over 8 år gamle og under opsyn. Hold apparatet og dets ledning uden for rækkevidde af børn under 8 år.
- Lad ikke børn lege med apparatet.
- Lad aldrig ledningen hænge ud over kanten af det bord eller den plads, som apparatet står på.
- For at undgå potential risiko eller skade, bør du kun anvende apparatet til sit tilsigtede formål.

Forsigtig

- Skyl altid apparatet med rent vand, før det tages i brug første gang.
- Placer aldrig apparatet på en varm overflade, og sørg for, at netledningen ikke kommer i berøring med varme flader.
- Placer ikke apparatet i et skab, når det er i brug.
- Tag stikket fra apparatet ud af kontakten før rengøring, og hvis der opstår problemer under brygning.
- Rengør altid apparatet, efter at det er kølet af.
- Når kaffen brygges eller holdes varm er vandtanken, filterholderen, varmepladen, den nederste del af apparatet og kanden med kaffe varme selv efter et stykke tid.
- Placer ikke kanden på komfuret eller i mikrobølgeovn for at genopvarme kaffen.
- Dette apparat er beregnet til brug i hjemmet og andre lignende steder; såsom gårde, bed and breakfast, personalekøkkener i butikker, på kontorer og på andre arbejdspladser. Det kan også benyttes af gæster på hoteller og moteller eller i andre beboelsesområder.
- Reparation og eftersyn af apparatet skal altid foretages på et Philips-autoriseret servicecenter. Skil ikke apparatet ad, og forsøg ikke at reparere det selv.
- Varmelegemetets overflade, filterholderen, nederste del af apparatet, varmepladen og kanden med kaffe bevarer restvarme i et stykke tid efter brug.
- Medmindre andet er angivet, er al emballage i æsken fremstillet af genbrugspapir. Se PAP-mærket på æsken.

Afkalkning

- Afkalk kaffemaskinen, når du bemærker, at der vises en afkalkningsadvarsel på displayet. Brug kun hvid eddike til afkalkning, da andre produkter kan beskadige apparatet.

Elektromagnetiske felter (EMF)

Dette Philips-apparat overholder standarderne i forhold til elektromagnetiske felter (EMF).

Genbrug



Dette symbol betyder, at dette produkt ikke må bortskaffes sammen med almindeligt husholdningsaffald (2012/19/EU)

Følg dit lands regler for særskilt indsamling af elektriske og elektroniske produkter. Korrekt bortskaffelse er med til at forhindre negativ påvirkning af miljøet og menneskers helbred.

Medmindre andet er angivet, er al emballage i æsken fremstillet af genbrugspapir. Se PAP-mærket på æsken.

Garanti og support

Versuni tilbyder to års garanti efter køb af dette produkt. Denne garanti er ikke gyldig, hvis en defekt skyldes forkert brug eller dårlig vedligeholdelse. Vores garanti påvirker ikke dine rettigheder i henhold til lovgivningen som forbruger. Gå til vores websted www.philips.com/support for at få flere oplysninger eller for at påberåbe dig garantien.

Før apparatet tages i brug

Sørg for at rengøre filterholderen og det permanente filter efter hver brug.

Tør filterholderen grundigt af med en tør klud efter hver brug. Sørg for at rengøre den for kondensvand.

Indstilling af uret

- 1 Sæt stikket i stikkontakten.
 - Timedisplayet begynder at blinke.

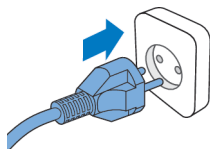

08:00



- 2 Brug piletasten til at indstille timeangivelsen.

08:



- 3 Når timetallet er indstillet, skal du trykke på timerknappen for at bekræfte timetallet.



08:06



- 4 Minutangivelsen begynder at blinke. Brug piletasterne for at indstille minutterne.

08:06



- 5 Tryk på timerknappen for at bekræfte de valgte minutter.



08:06

- Den viste tid er nu indstillet og gemt.
- 6 Hvis du vil justere timeren i standbytilstand, kan du vælge mellem to måder nedenfor:
 - Tag stikket ud af stikkontakten, og sæt det i igen.
 - Hold timerknappen nede, indtil timetallene begynder at blinke.

Bemærk

Apparatet gemmer altid den sidste indstilling.

Tid for holde varm

Du kan vælge, hvor længe kaffen skal forblive varm efter brygningen, ved at justere tiden efter, at apparatet automatisk slukkes. Den forudindstillede automatiske slukketid er 30 minutter. Den maksimale automatiske slukketid er 300 minutter.

Følg nedenstående trin for at justere den automatiske slukketid:

- 1 Sluk for apparatet, men lad stikket sidde i stikkontakten.
- 2 Hold rengøringsknappen nede, indtil hold varm-ikonet vises, og timetallene begynder at blinke.
- 3 Følg trinene i "Indstilling af uret" for at fuldføre indstillingen.

Gennemskylning

Gennemskyl altid kaffemaskinen én gang før brug ved at følge nedenstående trin.

Advarsel: Hæld aldrig vand i bønnebeholderen, da dette beskadiger kaffemaskinen.

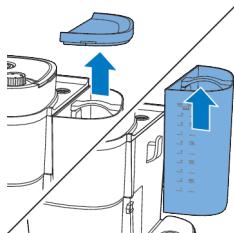

1 Åbn låget til vandbeholderen.

Forsigtig: Put ikke kaffebønner eller formalet kaffe i vandbeholderen

2 Du kan fylde vandbeholderen med vand på en af følgende måder, som vist nedenfor:

- Løft tanken fra apparatet, og placer den under vandhanen for at fylde vand i.



- Sørg for, at krogen er fastgjort korrekt, når den sættes tilbage.

- Tag fat i lågets tap for at trække kanden låg op. Sæt kaffekanden under vandhanen for at fylde vandtanken op.

- Sørg for, at vandmængden er under det maksimale niveau.

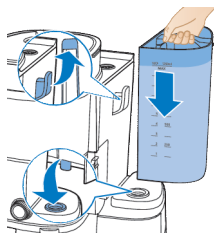

3 Luk låget til vandtanken.

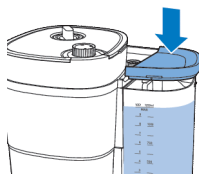

4 Placer kaffekanden i apparatet.

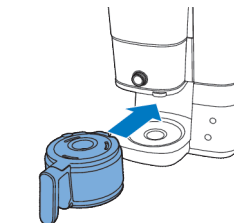

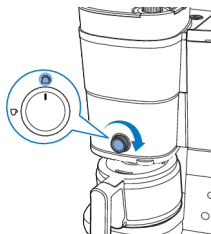

5 Drej på den midterste knap til kandeindstillingen.

☕ 3
10 3

6 Tryk på tænd/sluk-knappen.
- Apparatet er tændt.



7 Tryk på kaffestyrkeknappen, og vælg formalet kaffe.

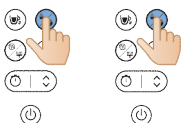

8 Tryk på kopknappen og vælg 10 kopper.

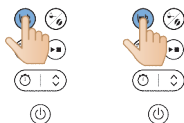

9 Tryk på startknappen.



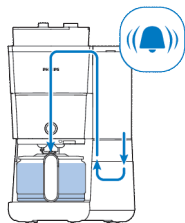

10 Apparatet starter skylningsprocessen.

11 Lad apparatet køre, indtil skylningsprocessen er afsluttet.



12 Tøm glaskanden.

Sådan bruges apparatet

Brug af kaffebønner

Bemærk: Kaffemaskinen vil bruge den krævede mængde vand baseret på antallet af kaffekopper, der skal tilberedes

Følg nedenstående trin for at anvende:

1 Åbn låget til vandbeholderen, og løft tanken ud af apparatet.

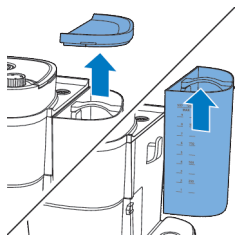

2 Fyld tanken med vand fra vandhanen.

- Sørg for, at vandmængden ikke overstiger det maksimale niveau.



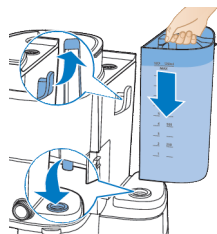

- 3 Placer tanken tilbage på apparatet.
 - Sørg for, at krogen fastgjort korrekt.

- 4 Luk låget på vandbeholderen.

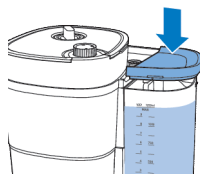

- 5 Løft låget på bønnebeholderen.

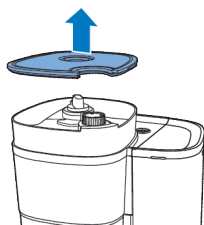

- 6 Kom de ønskede kaffebønner i beholderen.

Bemærk: Sørg altid for, at dobbeltbeholderen til friske kaffebønner er mindst halvt fuld.

Advarsel: Brug ikke uristede eller karamelliserede bønner, da kværnen tilstoppes. Brug kaffebønner i stedet for espressobønner, da espressobønner kan beskadige kværnen.

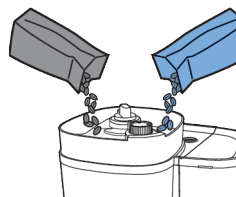

- 7 Luk låget på bønnebeholderen.

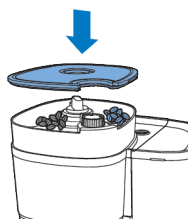

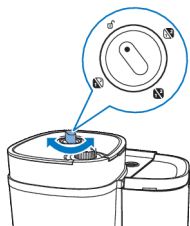

- 8** Drej knappen til beholdervalg for at vælge de ønskede bønner fra de to beholdere.
- Du kan endda blande to forskellige typer bønner for at få en specialblanding.

Bemærk: Når du skifter mellem bønnebeholdere eller kaffebønner, vil der altid være spor af kaffe tilbage af den tidligere formalede type bønner. Rengør møllekværnets tragt, når du skifter til en ny type kaffebønner for at undgå dette.

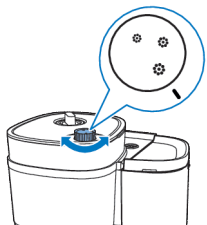

- 9** Vælg din fortrukne formalingsgrad ved hjælp af knappen.

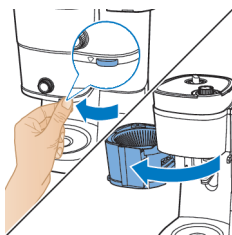

- 10** Tag fat i tappen for at åbne filterholderen.

- 11** Placer et papirfilter (type 1x4 eller nr. 4) i filterkurven.

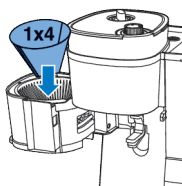

- 12** Luk filterholderen

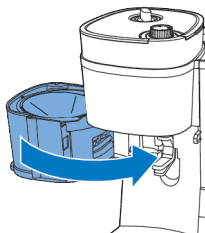

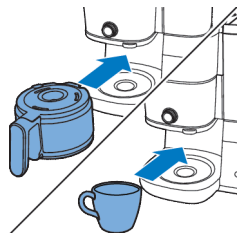

13 Sæt kaffekanden eller koppen under dispenseren.

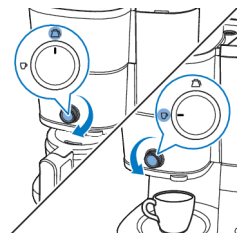

14 Brug knappen til at vælge den mængde kaffe, du vil lave.

Når du bruger funktionen til brygning i kop, kan du anvende enten glaskrus eller keramiske krus, samt glas. Sørg for at bruge kopper, som er lavere en 10 cm i højden.

10 3

15 Tænd for apparatet.



1 3

16 Vælg det antal kopper, du vil lave, ved at trykke på kopknappen.



1 2

17 Tryk på styrkeknappen for at vælge din fortrukne kaffestyrke.

- 1: Bønne til mild kaffe
- 2: bønner til mellemstærk kaffe
- 3: Bønner til stærk kaffe





18 Start processen ved at trykke på start/pause-knappen.

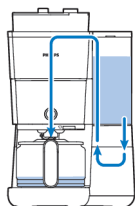

19 Apparatet påbegynder processen.

- Apparatet bipper, når det er færdigt.

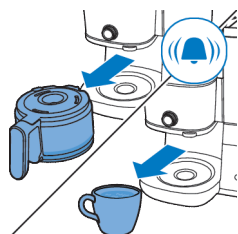

20 Fjern koppen eller kaffekanden fra apparatet.

Drypstopfunktionen gør det muligt at fjerne kanden fra kaffemaskinen, inden bryggeprocessen er færdig. Når du fjerner kanden, standser drypstoppet kaffetilførslen til kanden.

Bryggeprocessen stopper ikke, når du fjerner kanden. Hvis du ikke sætter kanden tilbage i apparatet inden for 20 sekunder, flyder filterkurven over.



21 Nyd din friskbrygede kaffe.

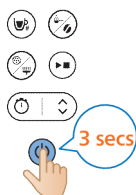

22 Hold start/pause-knappen nede i tre sekunder for at slukke apparatet.

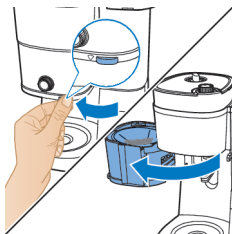

23 Luk filterholderen op.

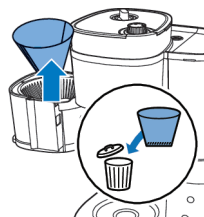

24 Fjern det brugte papirfilter.

Hold varm-funktionen aktiveres ikke, når du brygger en eller to 2 kopper.

Apparatet holder din drik varm, indtil det slukkes automatisk. Hvis din drik ikke længere skal holdes varm, skal du trykke på tænd/sluk-knappen for at slukke for apparatet.

Brug af formalet kaffe

Følg nedenstående trin for at anvende:

1 Kontroller, at apparatet har nok vand til at lave den ønskede mængde kaffe.

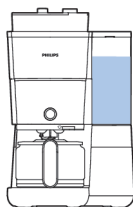

2 Tag fat i tappen for at åbne filterholderen.

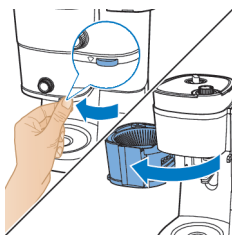

3 Placer et papirfilter (type 1x4 eller nr. 4) i filterkurven.

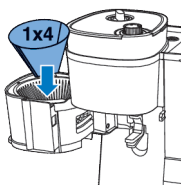

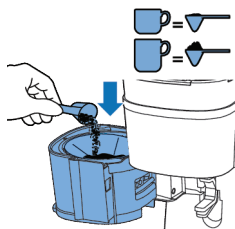

- 4 Tilføj den ønskede mængde formalet kaffe i papirfilteret. Mængden afhænger af dine præferencer.
- Til en almindelig kop kaffe skal du bruge 6 gram formalet kaffe eller 1 spiseskefuld.

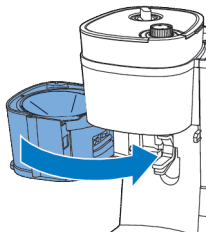

- 5 Luk filterholderen.

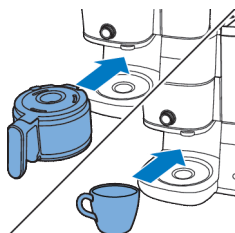

- 6 Sæt kaffekanden eller koppen under dispenseren.

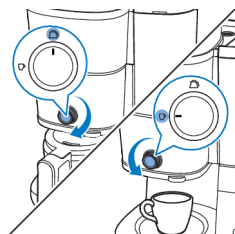

- 7 Brug knappen til at vælge den mængde kaffe, du vil lave.

WS 10 3

- 8 Tænd for apparatet.





9 Vælg brug af formalet kaffe ved at trykke på knappen til valg af tilstand.

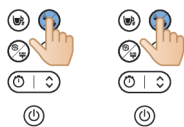

10 Vælg det antal kopper, du vil lave, ved at trykke på kopknappen.

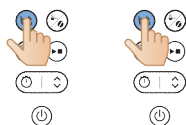

11 Start processen ved at trykke på start/pause-knappen.



12 Apparatet påbegynder processen.
- Apparatet bipper, når det er færdigt.

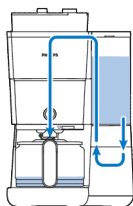

13 Fjern koppen eller kaffekanden fra apparatet.

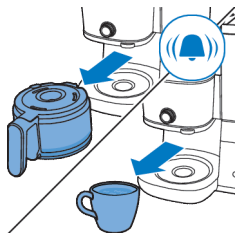



14 Nyd din friskbryggede kaffe.

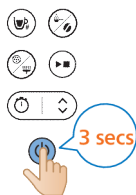

15 Hold start/pause-knappen nede i tre sekunder for at slukke apparatet.

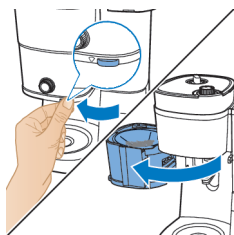

16 Luk filterholderen op.

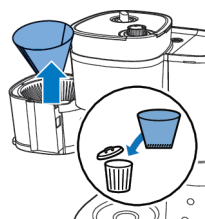

17 Fjern det brugte papirfilter.

Indstilling af timer

Følg disse trin for at indstille timeren på apparatet:

- 1** Tænd for kaffemaskinen.

08:05 

- 2 Når du trykker på timerknappen, vises timerikonet på displayet. Timetallene blinker for at angive indstilling af timer.



08:00

- 3 Brug pileknappen til at justere timetallet. Hold pileknappen, hvis du har brug for at justere hurtigt.



08: 

- 4 Tryk på timerknappen for at bekræfte timeindstillingen. Minuttallene angiver indstilling af minutter.



08:05

- 5 Brug pileknappen igen til at justere minutterne. Hold pileknappen, hvis du har brug for at justere hurtigt.



08:05 

- 6 Tryk på timerknappen for at bekræfte minutindstillingen.
Hvis du vil annullere timeren, skal du blot trykke på timerknappen, hvorefter timerikonet forsvinder fra displayet.



Drypstopfunktionen gør det muligt at fjerne kanden fra kaffemaskinen, inden bryggeprocessen er færdig. Når du fjerner kanden, standser drypstoppet kaffetilførslen til kanden.

Bemærk: Bryggeprocessen stopper ikke, når du fjerner kanden. Hvis du ikke sætter kanden tilbage i apparatet inden for 20 sekunder, flyder filterkurven over.

Rengøring og vedligeholdelse

Rengøring efter hver brug

Kaffemaskinen må aldrig nedsænkes i vand eller andre væsker eller skylles under vandhanen.

- 1 Tag stikket ud af stikkontakten.

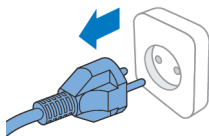









- 2 Tør kaffemaskinens yderside af med en fugtig klud.
- 3 Rengør filterkurven med varmt vand og lidt opvaskemiddel, eller vask den i opvaskemaskinen.



- 4 Rengør kaffekanden og låget ved at skylle dem under vandhanen. Eller vask dem i opvaskemaskinen.

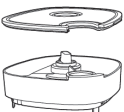

			
	✓	✓	✓
	✓	✓	✓
	✓	✓	✓
	✓	✗	✓
	✓	✗	✓

Rengøring af kværnens tragt

Vigtigt:

Rengør kværnens tragt med 1 til 2 ugers mellemrum for at undgå tilstopning med formalet kaffe. Dette gøres nemt og hurtigt ved at følge nedenstående trin.

Rengør kværnens tragt, når der vises et børsteikon på displayet.

Bemærk: Sørg for, at kaffebønnebeholderen er tom, før du starter rengøringen.

- 1 Sæt stikket i stikkontakten.

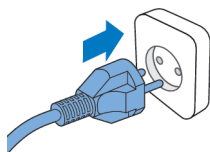

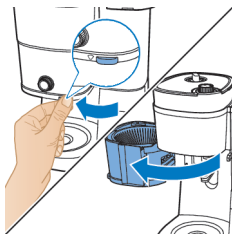

2 Åbn filterholderen for at få adgang kværnens tragtsliske.

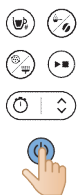

3 Tænd for kaffemaskinen.

4 Tryk på rengøringsknappen på maskinens kontrolpanel.

5 Vælg børsteindstillingen på displayet.



6 Tryk på startknappen. Dette vil få flappen på tragtens sliske til at åbne sig, så du kan rengøre slisken med en børste.

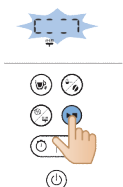

7 Brug en børste til at fjerne kaffegrums eller rester, der kan have samlet sig i slisken.

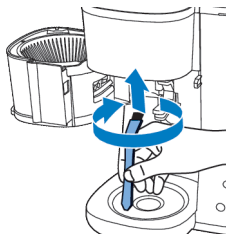



- 8 Efter rengøring af slisken skal du trykke på startknappen igen for at lukke flappen.

Afkalkning af kaffemaskinen

Afkalk kaffemaskinen, når du bemærker, at der vises en afkalkningsadvarsel på displayet. Brug kun hvid eddike til afkalkning, da andre produkter kan beskadige kaffemaskinen.

Advarsel: Brug aldrig eddike med et indhold af eddikesyre på 8 % eller højere, naturlig vineddike, afkalkningsmidler i pulver- eller tabletform til at afkalke apparatet, da dette kan medføre skader.

- 1 Åbn låget til vandbeholderen.

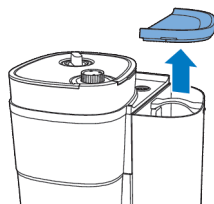

- 2 Fyld vandtanken med hvid eddike (4 % eddikesyre) op til markeringen af 10 kopper.

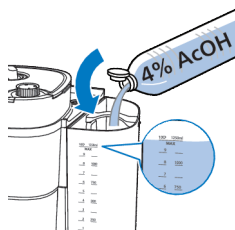

3 Luk låget på vandbeholderen.

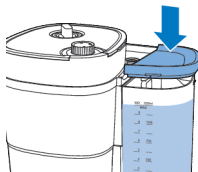

4 Tag fat i tappen for at åbne filterholderen.

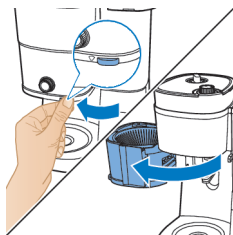

5 Placer et papirfilter (type 1x4 eller nr. 4) i filterkurven, og luk holderen til filterkurven.

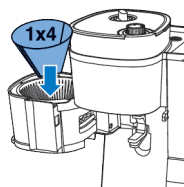

6 Sæt den tomme kande i kaffemaskinen.

7 Sæt stikket i en stikkontakt.

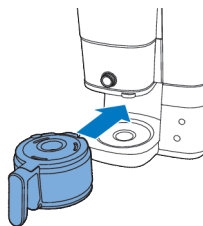

8 Tænd maskinen ved at trykke på startknappen. Displayet lyser.

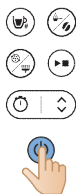

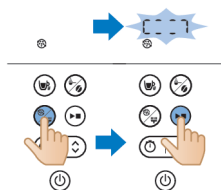

- 9 Tryk på rengøringsknappen på kaffemaskinen.
- 10 Vælg afkalkningsindstillingen.
- 11 Tryk på startknappen for at bekræfte valget.
 - Kaffemaskinen starter automatisk afkalkningsprocessen.

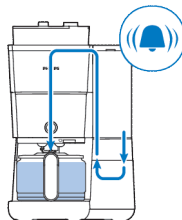

- 12 Vent, indtil maskinen er færdig med at brygge afkalkningsopløsningen.
- 13 Når afkalkningsprocessen er afsluttet, skal maskinen skylles to gange med den maksimale mængde vand for at fjerne eventuelle aflejringer helt.

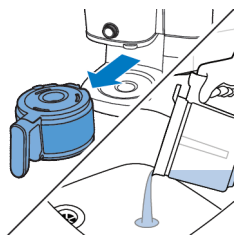

- 14 Tøm kanden, og fjern papirfilteret med kalkrester.
- 15 Fyld vandbeholderen med rent koldt vand, og tryk på startknappen for at starte endnu en bryggeproces.
 - Lad kaffemaskinen fuldføre hele bryggeprocessen, og tøm kanden.

Bemærk: Hvis det er nødvendigt, kan du gentage trin 14, indtil det vand, der kommer ud af kaffemaskinen, ikke længere smager eller lugter af eddike.

- 16 Rengør filterkurven og kanden med varmt vand og lidt opvaskemiddel.
- 17 Tryk på tænd/sluk-knappen for at slukke apparatet.

Fejlfinding

I dette kapitel beskrives de mest almindelige problemer, der kan opstå med maskinen. Hvis du ikke kan løse problemet ved hjælp af nedenstående oplysninger, kan du se en liste over ofte stillede spørgsmål på www.philips.com/support. Du er også altid velkommen til at kontakte dit lokale Philips Kundecenter.

Du kan også scanne denne QR-kode for at få mere onlinesupport.



Problem

Kaffemaskinen virker ikke.

Løsning

Sæt netstikket i stikkontakten, og tryk på tænd/sluk-knappen for at tænde for kaffemaskinen.

Kontroller, at den angivne netspænding på kaffemaskinen svarer til den lokale netspænding.

Fyld vandtanken med vand.

Luk låget til møllekværnens tragt.

Kværnen fungerer ikke eller fungerer ikke korrekt. Sørg for, at du ikke har valgt formalet kaffe. Hvis symbolet for formalet kaffe er synligt på displayet, har du valgt formalet kaffe.

Rengør kværnens tragt ved at følge instruktionerne.

Når jeg bruger kværnen, smager kaffen for svagt. Drej på knappen til formalingsgrad for at vælge den ønskede type formaling fra fin til grov.

Brug knappen til valg af styrke til at indstille kaffestyrken fra 1 til 3, et højt tal betyder højere styrke.

Brug kaffebønner med en stærkere blanding eller smag.

Når jeg bruger formalet kaffe, er kaffens styrke for svag. Vær sikker på, at mængden af formalet kaffe i filteret stemmer overens med mængden af vand i vandbeholderen. Vær opmærksom på, at kaffemaskinen bruger alt vandet i vandbeholderen.

Brug formalet kaffe med en stærkere blanding eller smag.

Hvis du vil øge kaffestyrken, skal du øge mængden af formalet kaffe eller reducere mængden af vand.

Filteret flyder over, når jeg fjerner kanden fra kaffemaskinen, mens den brygger kaffe. Hvis du fjerner kanden i mere end 20 sekunder under brygningen, får drypstoppet filterkurven til at flyde over. Bemærk også, at kaffen ikke får sin fulde smag, før bryggeprocessen er afsluttet. Derfor anbefaler vi, at du ikke fjerner kanden eller hælder af kaffen, før bryggeprocessen er afsluttet.

Kaffemaskinen fortsætter med at dryppe et stykke tid efter brygningens afslutning. Drypningen er forårsaget af kondenseret damp. Det er helt normalt, at kaffemaskinen drypper i et stykke tid.

Kan ikke vente på de sidste par dråber. Brug knappen til at skifte fra kop til kande for at åbne drypstopfunktionen, drypstop vil stoppe drypningen fra filterkurven.

Hvis drypningen ikke stopper, kan drypstoppet være tilstoppet. For at rengøre drypstoppet skal du åbne filterkurveholderen og tage filterkurven ud. Skyl filterkurven og drypstoppet under vandhanen.

Kaffen er ikke tilstrækkelig varm. Kaffen i kanden afkøles hurtigere, hvis du kun brygger nogle få kopper. Kaffen forbliver varm længere, hvis du brygger 10 kopper, hvilket svarer til en hel kande.

Afkalk kaffemaskinen.

Det lader til, at kaffebønnerne hurtigt er brugt op. For at brygge en perfekt kop kaffe skal kaffemaskinen bruge en vis mængde formalet kaffe. Den mængde kaffebønner, som kaffemaskinen bruger til at opnå den optimale mængde formalet kaffe pr. kop, er normal.

Timeren virker ikke. Sørg for at fuldføre alle trin for kaffebrygning med kaffebønner eller formalet kaffe, før du indstiller timeren.

Fejlkode

Fejlkode	Beskrivelse	Løsning	Bemærkning
E1	Vandmangel	Tryk på en vilkårlig knap for at sætte apparatet i standbytilstand. Fyld vandtanken igen, og genstart apparatet.	Hvis dette problem fortsætter, skal du følge disse trin: Hold rengørings- og startknappen nede samtidigt i tre sekunder, indtil apparatet automatisk begynder at pumpe vand i ét minut. Gentag denne proces 3 gange. Kontakt kundeservice, hvis problemet fortsætter.
E2	Bønnebeholder ikke tilgængelig	Tryk på en vilkårlig knap for at sætte apparatet i standbytilstand. Fastgør bønnebeholderen korrekt, og genstart apparatet	Kontakt kundeservice, hvis problemet fortsætter.
E3	Varmerør fungerer ikke korrekt	Tag apparatet ud af stikkontakten. Tilslut og tænd for apparatet igen, indtil det er kølet helt af.	Kontakt kundeservice, hvis problemet fortsætter.
E4	Kværnens hjul er blokeret	Tag apparatet ud af stikkontakten. Tilslut og tænd for apparatet igen. Følg trinene i "Rengøring af kværnens tragt" for at rengøre kværnens hjul og tragtssliske.	Kontakt kundeservice, hvis problemet fortsætter.
E5	Tragtslisen er tilstoppet	Tag apparatet ud af stikkontakten. Tilslut og tænd for apparatet igen. Følg trinene i "Rengøring af kværnens tragt" for at rengøre kværnens tragtssliske.	Kontakt kundeservice, hvis problemet fortsætter.
E6/E7/ E8	Programfejl	Tag apparatet ud af stikkontakten. Tilslut og tænd for apparatet igen.	Kontakt kundeservice, hvis problemet fortsætter.

Einführung

Herzlichen Glückwunsch zu Ihrem Kauf und willkommen bei Philips!

Um das Kundendienstangebot von Philips vollständig nutzen zu können, registrieren Sie Ihr Produkt unter www.philips.com/welcome.

Allgemeine Beschreibung

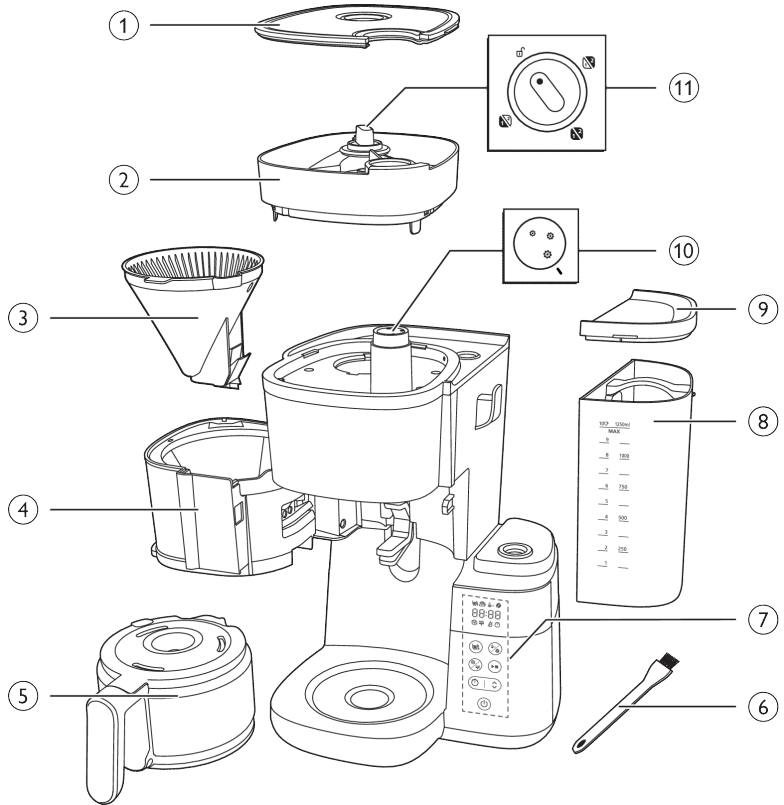

- 1 Deckel für Bohnenbehälter
- 2 Bohnenbehälter
- 3 Filterkorb
- 4 Filterkorbhalter
- 5 Glaskanne
- 6 Reinigungsbürste für Bohnenschütte
- 7 Bedienfeld mit Display
- 8 Wasserbehälter
- 9 Deckel für den Wasserbehälter
- 10 Drehregler für den Mahlgrad
- 11 Drehregler für die Behälterauswahl

Bedienfeld



Ein-/Ausschalter

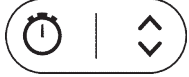

Timer-Taste und Pfeiltaste zur Zeiteinstellung



Start-/Pausetaste



Reinigungstaste



Taste für gemahlene Kaffee und Kaffeestärke



Taste zur Tassenauswahl

Anzeigesymbole



Anzahl der Tassen



Warmhaltemodus



Gemahlener Kaffee



Kaffeestärke



Entkalken



Manuelle Reinigungswarnung



Niedriger Wasserfüllstand



Timer



Zeitanzeige

Die ersten beiden Ziffern stellen die Stunden und die letzten beiden Ziffern die Minuten dar.



Bringen Sie den Drehregler in die Entriegelungsposition. Dann können Sie den Bohnenbehälter aus dem Gerät nehmen.



Mit diesem Drehregler wird der Mahlgrad des Kaffees eingestellt, wobei eine größere Größe für einen höheren Mahlgrad steht.



Kannenmodus

Tropf-Stopp-Funktion ist im Kannenmodus vorhanden.

Hinweis: Der Brühvorgang wird nicht unterbrochen, wenn Sie die Kanne herausnehmen. Wenn Sie die Kanne nicht innerhalb von 20 Sekunden wieder in das Gerät einsetzen, läuft der Filterkorb über.



Tassenmodus

Schalten Sie den Drehregler manuell von Tasse auf Kanne, um die Tropf-Stopp-Funktion zu öffnen und ein Tropfen zu verhindern, sobald der Brühvorgang abgeschlossen ist

Hinweis: Kalte Keramiktassen entziehen dem Kaffee Wärme, während er sich erwärmt. Bitte wärmen Sie die Tasse mit heißem Wasser vor.

Wichtig!

Achtung

- Prüfen Sie, bevor Sie das Gerät in Betrieb nehmen, ob die Spannungsangabe auf dem Gerät mit der örtlichen Netzspannung übereinstimmt.
- Schließen Sie das Gerät nur an eine geerdete Steckdose an.
- Verwenden Sie das Gerät nicht, wenn der Netzstecker, das Netzkabel oder das Gerät selbst defekt oder beschädigt sind.
- Ist das Netzkabel defekt, darf es nur von einem Philips Service-Center, einer von Philips autorisierten Werkstatt oder einer ähnlich qualifizierten Person durch ein Original-Ersatzkabel ausgetauscht werden, um Gefährdungen zu vermeiden.
- Dieses Gerät kann von Kindern ab 8 Jahren und Personen mit verringerten physischen, sensorischen oder psychischen Fähigkeiten oder Mangel an Erfahrung und Kenntnis verwendet werden, wenn sie bei der Verwendung beaufsichtigt wurden oder Anweisung zum sicheren Gebrauch des Geräts erhalten und die Gefahren verstanden haben. Die Reinigung und Wartung darf nicht von Kindern durchgeführt werden, außer Sie sind älter als 8 Jahre und beaufsichtigt. Bewahren Sie das Gerät und das Kabel außerhalb der Reichweite von Kindern unter 8 Jahren auf.
- Kinder dürfen nicht mit dem Gerät spielen.

- Lassen Sie das Netzkabel nicht über den Rand der Arbeitsfläche hängen, auf der das Gerät steht.
- Verwenden Sie dieses Gerät nur für den vorgesehenen Zweck, um mögliche Gefahren oder Verletzungen zu vermeiden.

Vorsicht

- Spülen Sie das Gerät vor dem ersten Gebrauch immer mit frischem Wasser durch.
- Stellen Sie das Gerät nicht auf eine heiße Oberfläche und lassen Sie das Netzkabel nicht mit heißen Oberflächen in Kontakt kommen.
- Stellen Sie das Gerät während des Gebrauchs nicht in einen Schrank.
- Ziehen Sie den Netzstecker aus der Steckdose, bevor Sie das Gerät reinigen und wenn während des Brühvorgangs Probleme auftreten.
- Reinigen Sie das Gerät immer, nachdem es abgekühlt ist.
- Während des Brühvorgangs und Warmhaltens sind der Wasserbehälter, der Filterhalter, die Warmhalteplatte, der untere Teil des Geräts und die Kanne, die mit Kaffee gefüllt ist, auch einige Zeit später noch heiß.
- Stellen Sie die Kanne nicht auf einen Herd oder eine Mikrowelle, um den Kaffee aufzuwärmen.
- Dieses Gerät ist für die Verwendung im Haushalt und in Einrichtungen wie Bauernhöfen, Frühstückspensionen, Mitarbeiterküchen in Geschäften, Büros und anderen Arbeitsumgebungen sowie für Kunden in Hotels, Motels und anderen Einrichtungen vorgesehen.
- Geben Sie das Gerät zur Überprüfung bzw. Reparatur stets an ein Philips Service-Center. Öffnen Sie das Gerät nicht, und versuchen Sie nicht, es selbst zu reparieren.
- Die Oberfläche des Heizelements, der Filterhalter, der untere Teil des Geräts, die Warmhalteplatte und die mit Kaffee gefüllte Kanne sind nach dem Gebrauch noch einige Zeit lang der Restwärme ausgesetzt.
- Sofern nicht anders angegeben, besteht das gesamte Verpackungsmaterial aus recyceltem Papier; siehe die PAP-Kennzeichnung auf der Verpackung.

Entkalken

- Entkalken Sie die Kaffeemaschine, wenn eine Entkalkungsmeldung auf dem Display angezeigt wird. Verwenden Sie zum Entkalken nur Haushaltsessig, da andere Produkte das Gerät beschädigen können.

Elektromagnetische Felder

Dieses Philips Gerät erfüllt sämtliche Normen bezüglich elektromagnetischer Felder.

Recycling



Dieses Symbol bedeutet, dass das Produkt nicht mit dem normalen Hausmüll entsorgt werden kann (2012/19/EU).

Befolgen Sie die örtlichen Bestimmungen zur getrennten Entsorgung von elektrischen und elektronischen Produkten. Eine ordnungsgemäße Entsorgung hilft, negative Auswirkungen auf Umwelt und Gesundheit zu vermeiden.

Sofern nicht anders angegeben, besteht das gesamte Verpackungsmaterial aus recyceltem Papier; siehe die PAP-Kennzeichnung auf der Verpackung.

Garantie und Support

Versuni bietet für dieses Produkt nach dem Kauf eine zweijährige Garantie. Diese Garantie gilt nicht, wenn ein Defekt auf unsachgemäße Verwendung oder mangelhafte Wartung zurückzuführen ist. Unsere Garantie berührt Ihre gesetzlichen Rechte als Verbraucher nicht. Für weitere Informationen oder um Ihre Garantie in Anspruch zu nehmen, besuchen Sie unsere Website www.philips.com/support.

Vor dem ersten Gebrauch

Reinigen Sie den Filterhalter und den Dauerfilter nach jedem Gebrauch.

Wischen Sie den Filterhalter nach jedem Gebrauch gründlich mit einem trockenen Tuch ab. Achten Sie darauf, dass keine Kondensat-Ansammlung vorhanden ist.

Einstellen der Uhr

- 1 Stecken Sie den Netzstecker in die Steckdose.
 - Die Stundenanzeige beginnt zu blinken.

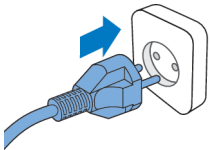

08:00



- 2 Verwenden Sie die Pfeiltaste zum Einstellen der Stunde.

08: 

- 3 Sobald die Stunde eingestellt ist, drücken Sie die Timer-Taste, um die Stunde zu bestätigen.

08:06



- 4 Die Minutenanzeige beginnt zu blinken. Stellen Sie mit der Pfeiltaste die Minuten ein.

08:06 

- 5 Drücken Sie die Timer-Taste, um die Minuteneinstellung zu bestätigen.



08:06

- Die aktuelle Uhrzeit ist nun eingestellt und gespeichert.
- 6 Um den Timer im Standby-Modus einzustellen, können Sie zwischen zwei Methoden wählen:
- Trennen Sie das Gerät von der Stromversorgung und schließen Sie es wieder an.
 - Halten Sie die Timer-Taste gedrückt, bis die Ziffern für die Stundenanzeige blinken.

Hinweis

Das Gerät speichert immer die letzte Einstellung.

Warmhaltezeit

Sie können wählen, wie lange Ihr Kaffee nach dem Brühvorgang heiß bleiben soll, indem Sie die Zeit ändern, nach der das Gerät automatisch ausgeschaltet wird. Die standardmäßige Abschaltzeit beträgt 30 Minuten. Die maximale Abschaltzeit beträgt 300 Minuten.

Um die automatische Abschaltzeit zu ändern, gehen Sie wie folgt vor:

- 1 Schalten Sie das Gerät aus und lassen Sie es am Stromnetz angeschlossen.
- 2 Halten Sie die Reinigungstaste gedrückt, bis das Warmhaltesymbol angezeigt wird und die Stundenanzeige blinkt.
- 3 Befolgen Sie die Schritte unter "Einstellen der Uhr", um die Einstellung abzuschließen.

Durchspülen des Geräts

Spülen Sie die Kaffeemaschine vor dem ersten Gebrauch immer einmal durch, indem Sie die folgenden Schritte befolgen.

Warnung: Füllen Sie niemals Wasser in den Bohnenbehälter, da dies die Kaffeemaschine beschädigt.

1 Öffnen Sie den Deckel des Wasserbehälters.

Achtung: Geben Sie keine Kaffeebohnen oder gemahlene Kaffeebohnen in den Wasserbehälter.

2 Sie können den Wasserbehälter wie folgt mit Wasser füllen:

- Heben Sie den Wasserbehälter aus dem Gerät und stellen Sie ihn unter einen Wasserhahn, um Wasser einzufüllen.

- Stellen Sie sicher, dass der Haken richtig befestigt ist, wenn Sie den Wasserbehälter wieder einsetzen.

- Nutzen Sie die Deckellasche, um den Kannendeckel nach oben zu ziehen. Stellen Sie die Kaffeekanne unter einen Wasserhahn, um Wasser aufzufüllen. Füllen Sie den Wasserbehälter mit dem Wasser aus der Kaffeekanne.

- Stellen Sie sicher, dass der Wasserstand unter dem maximalen Füllstand liegt.

3 Schließen Sie den Deckel des Wasserbehälters.

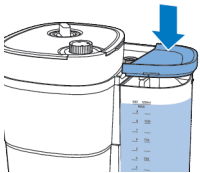
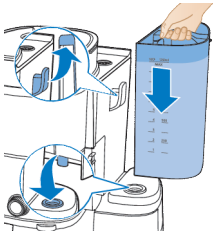
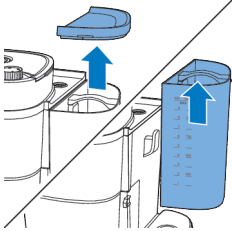

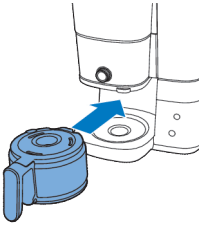

4 Setzen Sie die Kaffeekanne in das Gerät ein.

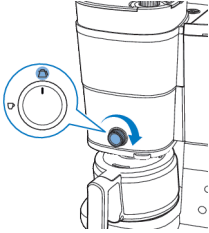

5 Drehen Sie den mittleren Drehregler auf die Kanneneinstellung.



6 Drücken Sie auf den Ein-/Ausschalter.
- Das Gerät ist eingeschaltet.



7 Drücken Sie die Kaffeestärke-Taste und wählen Sie die Funktion für gemahlene Kaffee aus.

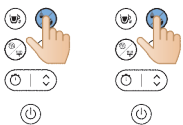

8 Drücken Sie die Tassen-Taste und wählen Sie 10 Tassen aus.

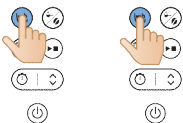



9 Drücken Sie die Starttaste.

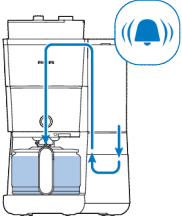

10 Das Gerät beginnt mit dem Durchspülen.

11 Lassen Sie das Gerät laufen, bis der Spülvorgang abgeschlossen ist.



12 Leeren Sie die Glaskanne.

Das Gerät benutzen

Kaffeebohnen benutzen

Hinweis: Die Kaffeemaschine verbraucht die erforderliche Menge Wasser basierend auf der Anzahl der Kaffeetassen, die zubereitet werden müssen.

Befolgen Sie die folgenden Schritte:

1 Öffnen Sie den Deckel des Wasserbehälters und nehmen Sie den Behälter aus dem Gerät.

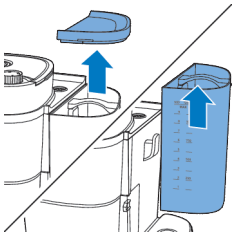



- 2 Füllen Sie den Behälter mit Wasser aus dem Wasserhahn.
- Stellen Sie sicher, dass das Wasser nicht den maximalen Füllstand überschreitet.

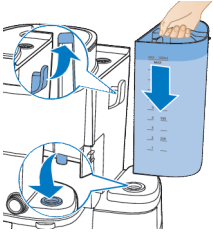

- 3 Setzen Sie den Behälter wieder in das Gerät ein.
- Vergewissern Sie sich, dass der Haken ordnungsgemäß einrastet.

- 4 Schließen Sie den Deckel des Wasserbehälters.

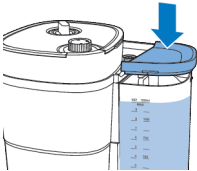

- 5 Heben Sie den Deckel des Bohnenbehälters an.

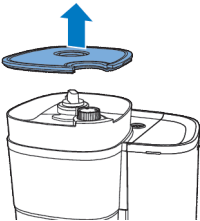

- 6 Geben Sie die gewünschten Kaffeebohnen in den Behälter.

Hinweis: Stellen Sie immer sicher, dass die doppelte Kammer für frische Bohnen mindestens zur Hälfte gefüllt ist.

Warnung: Verwenden Sie keine ungerösteten oder karamellisierten Bohnen, um ein Blockieren des Mahlwerks zu verhindern. Verwenden Sie Kaffeebohnen anstelle von Espresso-Bohnen, da Espresso-Bohnen das Mahlwerk beschädigen können.

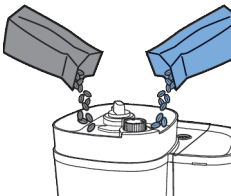

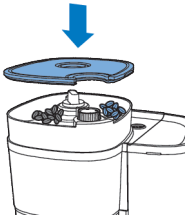

7 Schließen Sie den Deckel des Bohnenbehälters.

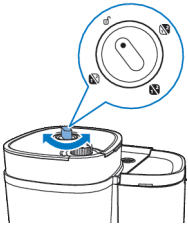

8 Drehen Sie den Drehregler für die Behälterauswahl, um zwischen den gewünschten Bohnen der beiden Behälter auszuwählen.
- Sie können sogar zwei verschiedene Arten von Bohnen mischen, um eine einzigartige Mischung zu erhalten.

Hinweis: Wenn Sie zwischen Kaffeebohnenbehältern oder Kaffeebohnen wechseln, sind immer Spuren der zuvor gemahlene Kaffeebohnenart übrig. Reinigen Sie den Mahltrichter nach dem Wechsel zu einer neuen Kaffeebohnenart, um dies zu verhindern.

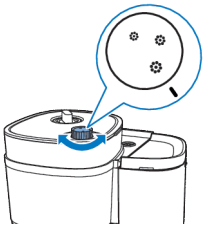

9 Wählen Sie den gewünschten Mahlgrad mit dem Drehregler aus.

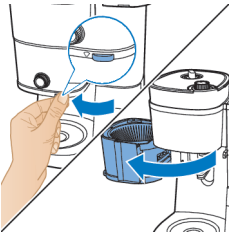

10 Greifen Sie die Lasche, um den Filterhalter zu öffnen.

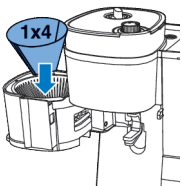

11 Setzen Sie eine Papierfiltertüte (Typ 1x4 bzw. Nr. 4) in den Filterkorb ein.

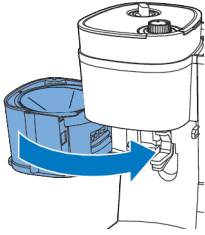

12 Schließen Sie den Filterhalter.

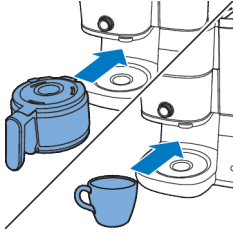

13 Stellen Sie die Kaffeekanne oder Ihre Tasse unter den Spender.

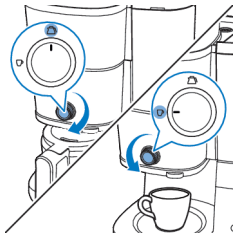

14 Verwenden Sie den Drehregler, um die Kaffeemenge auszuwählen, die Sie zubereiten möchten.

Wenn Sie die Funktion "In Tasse brühen" verwenden, können Sie entweder Glas- oder Keramiktassen sowie Gläser verwenden. Stellen Sie sicher, dass Sie Tassen mit einer Höhe von weniger als 10 cm verwenden.



15 Schalten Sie das Gerät ein.

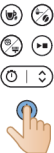

16 Wählen Sie die Anzahl der Tassen aus, die Sie zubereiten möchten, indem Sie die Tassen-Taste drücken.





- 17** Drücken Sie die Taste für die Kaffeestärke, um Ihre bevorzugte Kaffeestärke auszuwählen.
- 1: Bohnen für milden Kaffee
 - 2: Bohnen für mittelstarken Kaffee
 - 3: Bohnen für starken Kaffee



- 18** Starten Sie den Vorgang, indem Sie die Start-/Pause-Taste drücken.



- 19** Das Gerät startet den Vorgang.
- Das Gerät gibt einen Signalton aus, wenn es fertig ist.

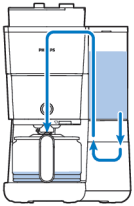

- 20** Nehmen Sie Ihre Tasse oder die Kaffeekanne aus dem Gerät.

Mit der Tropf-Stopp-Funktion können Sie die Kanne aus der Kaffeemaschine nehmen, bevor der Brühvorgang abgeschlossen ist. Wenn Sie die Kanne herausnehmen, stoppt die Tropf-Stopp-Funktion den Kaffeefluss in die Kanne.

Der Brühvorgang wird nicht unterbrochen, wenn Sie die Kanne herausnehmen. Wenn Sie die Kanne nicht innerhalb von 20 Sekunden wieder in das Gerät einsetzen, läuft der Filterkorb über.

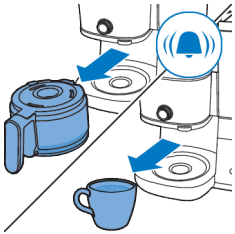

- 21** Genießen Sie Ihren frisch gebrühten Kaffee.





22 Halten Sie die Start-/Pause-Taste drei Sekunden lang gedrückt, um das Gerät auszuschalten.

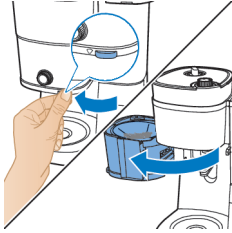

23 Öffnen Sie den Filterhalter.

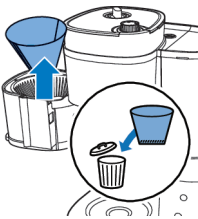

24 Nehmen Sie den benutzten Papierfilter heraus.

Die Warmhaltefunktion wird beim Brühen von einer oder zwei Tassen nicht aktiviert.

Das Gerät hält Ihr Getränk warm, bis es sich automatisch ausschaltet. Wenn das Getränk nicht mehr warm gehalten werden soll, drücken Sie den Ein-/Ausschalter, um das Gerät auszuschalten.

Verwenden von gemahlenem Kaffee

Befolgen Sie die folgenden Schritte:

- 1** Vergewissern Sie sich, dass das Gerät genug Wasser für die gewünschte Kaffeemenge hat.

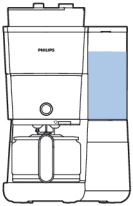

- 2** Greifen Sie die Lasche, um den Filterhalter zu öffnen.

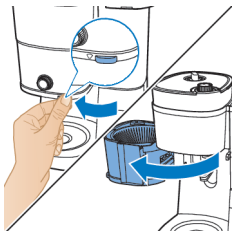

3 Setzen Sie einen Papierfilter (Typ 1x4 bzw. Nr. 4) in den Filterkorb ein.

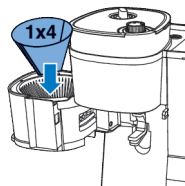

4 Geben Sie die gewünschte Menge gemahlene Kaffees in die Papierfiltertüte.
- Für eine Standardtasse Kaffee verwenden Sie 6 g gemahlene Kaffee oder 1 Esslöffel.

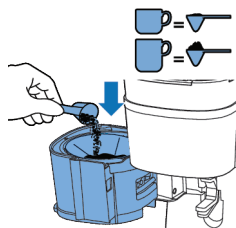

5 Schließen Sie den Filterhalter.

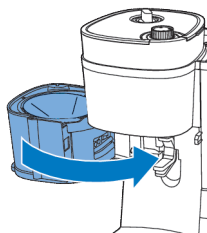

6 Stellen Sie die Kaffeekanne oder Ihre Tasse unter den Spender.

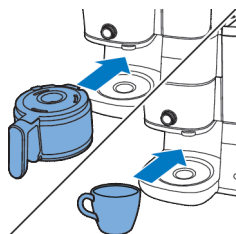

7 Verwenden Sie den Drehregler, um die Kaffeemenge auszuwählen, die Sie zubereiten möchten.

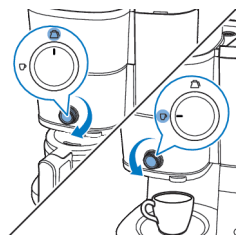



8 Schalten Sie das Gerät ein.



9 Wählen Sie gemahlene Kaffee, indem Sie die Moduswahl-taste drücken.



10 Wählen Sie die Anzahl der Tassen aus, die Sie zubereiten möchten, indem Sie die Tassen-Taste drücken.

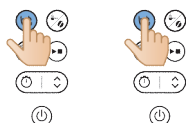

11 Starten Sie den Vorgang, indem Sie die Start-/Pause-Taste drücken.



12 Das Gerät startet den Vorgang.
- Das Gerät gibt einen Signalton aus, wenn es fertig ist.

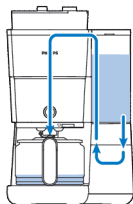

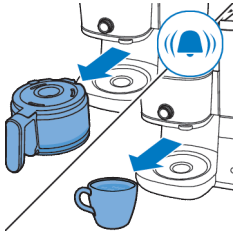

13 Nehmen Sie Ihre Tasse oder die Kaffeekanne aus dem Gerät.



14 Genießen Sie Ihren frisch gebrühten Kaffee.

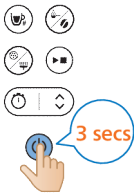

15 Halten Sie die Start-/Pause-Taste drei Sekunden lang gedrückt, um das Gerät auszuschalten.

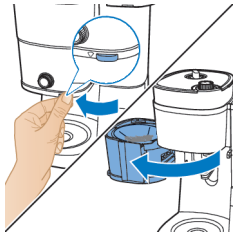

16 Öffnen Sie den Filterhalter.

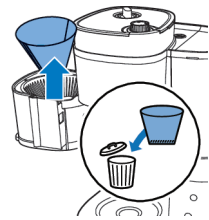

17 Nehmen Sie den benutzten Papierfilter heraus.

Setting the timer

To set the timer on the appliance, follow these steps:

- 1 Turn on the coffee machine.
- 2 Press the timer button and the timer icon will appear on the display. The hour digits flash to indicate setting hour.

08:06 



08:00



- 3 Use the arrow button to adjust the hours. If you need to adjust quickly, long-press the arrow button.

08: 



- 4 Press the timer button to confirm the hour setting. The minutes digits indicate setting minute.

08:06



- 5 Use the arrow button again to adjust the minutes. If you need to adjust quickly, long-press the arrow button.

08:05



- 6 Press the timer button again to confirm the minute setting.

To cancel the timer, simply press the timer button, and the timer icon will disappear from the display.

Note: The brewing process does not stop when you remove the jug. If you do not put the jug back into the appliance within 20 seconds, the filter basket overflows.

Reinigung und Wartung

Reinigung nach jedem Gebrauch

Tauchen Sie das Gerät niemals in Wasser oder andere Flüssigkeiten; spülen Sie es auch nicht unter fließendem Wasser ab.

- 1 Ziehen Sie den Netzstecker aus der Steckdose.

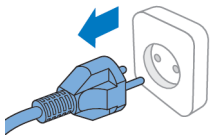









- 2 Reinigen Sie das Gerät von außen mit einem feuchten Tuch.
3 Reinigen Sie den Filterkorb mit heißem Wasser und etwas Spülmittel, oder reinigen Sie ihn in der Spülmaschine.



- 4 Reinigen Sie die Kaffeekanne und den Deckel, indem Sie sie unter fließendem Wasser abspülen. Oder reinigen Sie sie in der Spülmaschine.

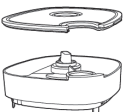

			
	✓	✓	✓
	✓	✓	✓
	✓	✓	✓
	✓	✗	✓
	✓	✗	✓

Reinigen des Mahltrichters

Wichtig:

Reinigen Sie den Mahltrichter alle 1 bis 2 Wochen, um ein Verstopfen mit gemahlenem Kaffee zu vermeiden. Das geht ganz einfach und schnell, indem Sie die folgenden Schritte ausführen:

Reinigen Sie den Mahltrichter, wenn auf dem Display eine Bürste angezeigt wird.

Hinweis: Vergewissern Sie sich, dass der Kaffeebohnenbehälter leer ist, bevor Sie mit dem Reinigungsvorgang beginnen.

- 1 Stecken Sie den Netzstecker in die Steckdose.

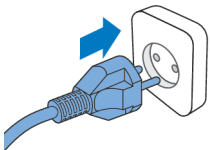

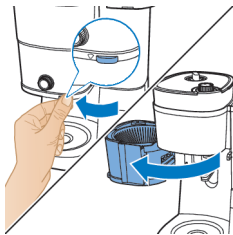

2 Öffnen Sie den Filterhalter, um Zugang zur Trichterschütte zu erhalten.

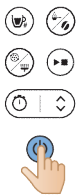

3 Schalten Sie die Kaffeemaschine ein.

4 Drücken Sie die Reinigungstaste auf dem Bedienfeld des Geräts.

5 Wählen Sie die Bürsteneinstellung auf dem Display aus.



6 Drücken Sie die Starttaste. Dadurch öffnet sich die Klappe der Trichterschütte, sodass Sie die Schütte mit einer Bürste reinigen können.



7 Verwenden Sie eine Bürste, um Kaffeesatz oder Rückstände zu entfernen, die sich möglicherweise in der Schütte angesammelt haben.

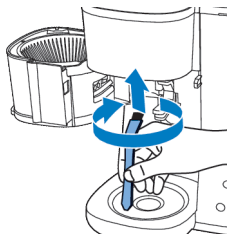



- 8 Drücken Sie nach dem Reinigen der Schütte erneut die Start-Taste, um die Klappe zu schließen.



Entkalken der Kaffeemaschine

Entkalken Sie die Kaffeemaschine, wenn eine Entkalkungsmeldung auf dem Display angezeigt wird. Verwenden Sie zum Entkalken nur Haushaltsessig, da andere Produkte die Kaffeemaschine beschädigen können.

Warnung: Verwenden Sie zum Entkalken der Maschine niemals Essig mit einem Essigsäuregehalt von 8 % oder mehr, natürlichen Essig, Entkalker in Pulverform oder Entkalker in Tablettenform, da dies zu Schäden führen kann.

- 1 Öffnen Sie den Deckel des Wasserbehälters.

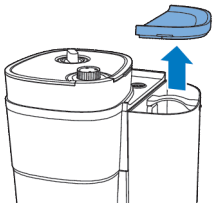

- 2 Füllen Sie den Wasserbehälter bis zur Markierung für 10 Tassen mit Haushaltsessig (4 % Essigsäuregehalt).

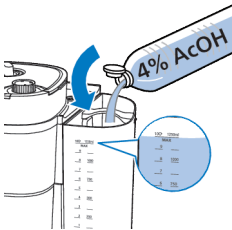

3 Schließen Sie den Deckel des Wasserbehälters.

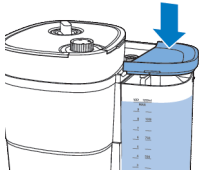

4 Greifen Sie die Lasche, um den Filterhalter zu öffnen.

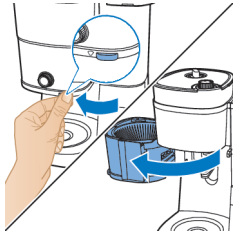

5 Legen Sie einen Papierfilter (Typ 1x4 bzw. Nr. 4) in den Filterkorb und schließen Sie den Filterkorbhalter.

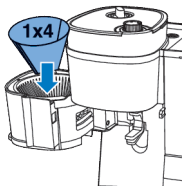

6 Stellen Sie die leere Kanne in die Kaffeemaschine.

7 Stecken Sie den Stecker in die Steckdose.

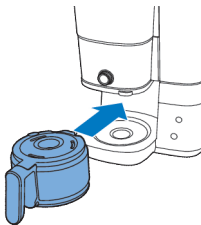

8 Drücken Sie den Ein-/Ausschalter, um die Kaffeemaschine einzuschalten. Das Display leuchtet auf.

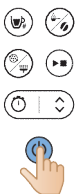

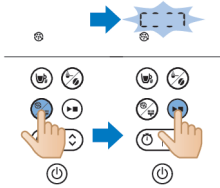

- 9 Drücken Sie die Reinigungstaste an der Kaffeemaschine.
- 10 Wählen Sie die Einstellung für das Entkalken aus.
- 11 Drücken Sie die Starttaste, um die Auswahl zu bestätigen.
 - Die Kaffeemaschine beginnt automatisch mit dem Entkalkungsvorgang.

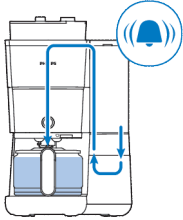

- 12 Warten Sie, bis die Maschine die Entkalkungslösung fertig zubereitet hat.
- 13 Spülen Sie das Gerät nach Abschluss des Entkalkungsvorgangs zweimal mit der maximalen Wassermenge aus, um alle Ablagerungen vollständig zu entfernen.



- 14 Leeren Sie die Kanne und entfernen Sie den Papierfilter mit den Kalkrückständen.
- 15 Füllen Sie den Wasserbehälter mit frischem, kaltem Wasser auf und drücken Sie die Start-Taste, um einen weiteren Brühvorgang zu starten.

Lassen Sie die Kaffeemaschine den Brühvorgang vollenden und leeren Sie die Kanne anschließend.

Hinweis: Wiederholen Sie bei Bedarf Schritt 14, bis das aus der Kaffeemaschine austretende Wasser nicht mehr nach Essig schmeckt oder riecht.

- 16 Reinigen Sie den Filterkorb und die Kanne mit heißem Wasser und etwas Spülmittel.
- 17 Drücken Sie den Ein-/Ausschalter, um das Gerät auszuschalten.

Fehlerbehebung

In diesem Kapitel sind die häufigsten Probleme aufgeführt, die beim Gebrauch des Geräts auftreten können. Sollten Sie ein Problem mithilfe der nachstehenden Informationen nicht beheben können, besuchen Sie unsere Website unter www.philips.com/support, auf der Sie eine Liste mit häufig gestellten Fragen finden, oder wenden Sie sich an das Service-Center in Ihrem Land. Sie können diesen QR-Code auch scannen, um mehr Online-Support zu erhalten.



Problem

Lösung

Die Kaffeemaschine funktioniert nicht.	Stecken Sie den Netzstecker in die Steckdose und drücken Sie den Ein-/Ausschalter, um die Kaffeemaschine einzuschalten.
	Prüfen Sie, ob die Spannungsangabe auf der Kaffeemaschine mit der örtlichen Netzspannung übereinstimmt.
	Füllen Sie den Wasserbehälter mit Wasser.
	Schließen Sie den Deckel des Mahltrichters.
Das Mahlwerk funktioniert nicht oder nicht ordnungsgemäß.	Vergewissern Sie sich, dass Sie nicht gemahlene Kaffeebohnen ausgewählt haben. Wenn das Symbol für gemahlene Kaffeebohnen auf dem Display angezeigt wird, haben Sie gemahlene Kaffeebohnen ausgewählt.
	Reinigen Sie den Mahltrichter gemäß der Anweisungen.
Wenn ich das Mahlwerk verwende, ist der Kaffee zu schwach.	Drehen Sie den Drehregler für den Mahlgrad, um den gewünschten Mahlgrad von fein bis grob auszuwählen.
	Verwenden Sie die Taste zur Einstellung der Kaffeestärke, um die Kaffeestärke auf einen Wert zwischen 1 und 3 einzustellen. Die größere Ziffer bedeutet eine stärkere Kaffeestärke.
	Verwenden Sie Kaffeebohnen mit einer geschmacksstärkeren Mischung oder stärkerem Geschmack.
Wenn ich gemahlene Kaffeebohnen verwende, ist der Kaffee zu schwach.	Vergewissern Sie sich, dass die Menge an gemahlener Kaffeebohnen im Filter mit der Menge an Wasser im Wasserbehälter übereinstimmt. Bitte beachten Sie, dass die Kaffeemaschine das gesamte Wasser im Wasserbehälter verbraucht.
	Verwenden Sie gemahlene Kaffeebohnen mit einer geschmacksstärkeren Mischung oder einem stärkeren Geschmack.
	Um die Kaffeestärke zu erhöhen, erhöhen Sie die Menge des gemahlene Kaffees oder verringern Sie die Wassermenge.
Der Filter läuft über, wenn ich die Kanne während der Kaffeezubereitung aus der Kaffeemaschine nehme.	Wenn Sie die Kanne während des Brühvorgangs länger als 20 Sekunden herausnehmen, führt die Tropf-Stopp-Funktion dazu, dass der Filterkorb überläuft. Beachten Sie auch, dass der Kaffee seinen vollen Geschmack nicht vor dem Ende des Brühvorgangs erreicht. Daher empfehlen wir Ihnen, die Kanne nicht zu entfernen und den Kaffee nicht vor dem Ende des Brühvorgangs auszugießen.
Die Kaffeemaschine tropft noch lange nach Abschluss des Brühvorgangs.	Das Tropfen wird durch Kondensation von Dampf verursacht. Es ist völlig normal, dass die Kaffeemaschine eine Zeit lang tropft.
Ich habe keine Zeit, auf die letzten Tropfen zu warten.	Schalten Sie den Drehregler von Tasse auf Kanne, um die Tropf-Stopp-Funktion zu aktivieren. Die Tropf-Stopp-Funktion stoppt das Tropfen aus dem Filterkorb.
	Wenn das Tropfen nicht aufhört, ist der Tropf-Stopp möglicherweise verstopft. Um den Tropf-Stopp zu reinigen, öffnen Sie den Filterkorbbalger, und nehmen Sie den Filterkorb heraus. Spülen Sie den Filterkorb und den Tropf-Stopp unter fließendem Wasser ab.

Der Kaffee ist nicht heiß genug.

Der Kaffee in der Kanne kühlt schneller ab, wenn Sie nur ein paar Tassen zubereiten. Der Kaffee bleibt länger heiß, wenn Sie 10 Tassen zubereiten, also eine volle Kanne.

Entkalken Sie die Kaffeemaschine.

Die Kaffeebohnen scheinen schnell verbraucht zu sein.

Um eine perfekte Tasse Kaffee zuzubereiten, benötigt die Kaffeemaschine eine bestimmte Menge gemahlene Kaffees. Die Menge an Kaffeebohnen, die die Kaffeemaschine verwendet, um die optimale Menge an gemahlendem Kaffee pro Tasse zu erhalten, ist normal.

Der Timer funktioniert nicht.

Stellen Sie sicher, dass Sie alle Schritte zum Brühen von Kaffee mit Kaffeebohnen oder gemahlendem Kaffee abgeschlossen haben, bevor Sie den Timer einstellen.

Fehlercode

Fehlercode	Beschreibung	Lösung	Anmerkung
E1	Zu wenig Wasser	Drücken Sie eine beliebige Taste, um das Gerät in den Standby-Modus zu versetzen. Füllen Sie den Wasserbehälter auf und starten Sie das Gerät neu.	Wenn das Problem weiterhin besteht, gehen Sie wie folgt vor: Halten Sie die Reinigungs- und Starttasten gleichzeitig drei Sekunden lang gedrückt, bis das Gerät automatisch beginnt, eine Minute lang Wasser zu pumpen. Wiederholen Sie diesen Vorgang drei Mal. Wenden Sie sich an den Kundendienst, wenn das Problem weiterhin besteht.
E2	Bohnenbehälter nicht verfügbar	Drücken Sie eine beliebige Taste, um das Gerät in den Standby-Modus zu versetzen. Setzen Sie den Bohnenbehälter richtig ein und starten Sie das Gerät neu.	Wenden Sie sich an den Kundendienst, wenn das Problem weiterhin besteht.
E3	Fehlfunktion des Heizrohrs	Ziehen Sie den Netzstecker aus der Steckdose. Schließen Sie das Gerät wieder an und schalten Sie es ein, bis es vollständig abgekühlt ist.	Wenden Sie sich an den Kundendienst, wenn das Problem weiterhin besteht.
E4	Mahlrad blockiert	Ziehen Sie den Netzstecker aus der Steckdose. Schließen Sie das Gerät an und schalten Sie es wieder ein. Befolgen Sie die Schritte unter "Reinigen des Mahltrichters", um das Mahlrad und die Trichterschütte zu reinigen.	Wenden Sie sich an den Kundendienst, wenn das Problem weiterhin besteht.

E5	Trichterschütte blockiert	Ziehen Sie den Netzstecker aus der Steckdose. Schließen Sie das Gerät an und schalten Sie es wieder ein. Befolgen Sie die Schritte unter "Reinigen des Mahltrichters", um die Trichterschütte zu reinigen.	Wenden Sie sich an den Kundendienst, wenn das Problem weiterhin besteht.
E6/E7/E8	Programmfehler	Ziehen Sie den Netzstecker aus der Steckdose. Schließen Sie das Gerät an und schalten Sie es wieder ein.	Wenden Sie sich an den Kundendienst, wenn das Problem weiterhin besteht.

Introducción

Le damos la enhorabuena por su adquisición y la bienvenida a Philips.

Para poder beneficiarse por completo de la asistencia que ofrece Philips, registre el producto en www.Philips.com/welcome.

Descripción general

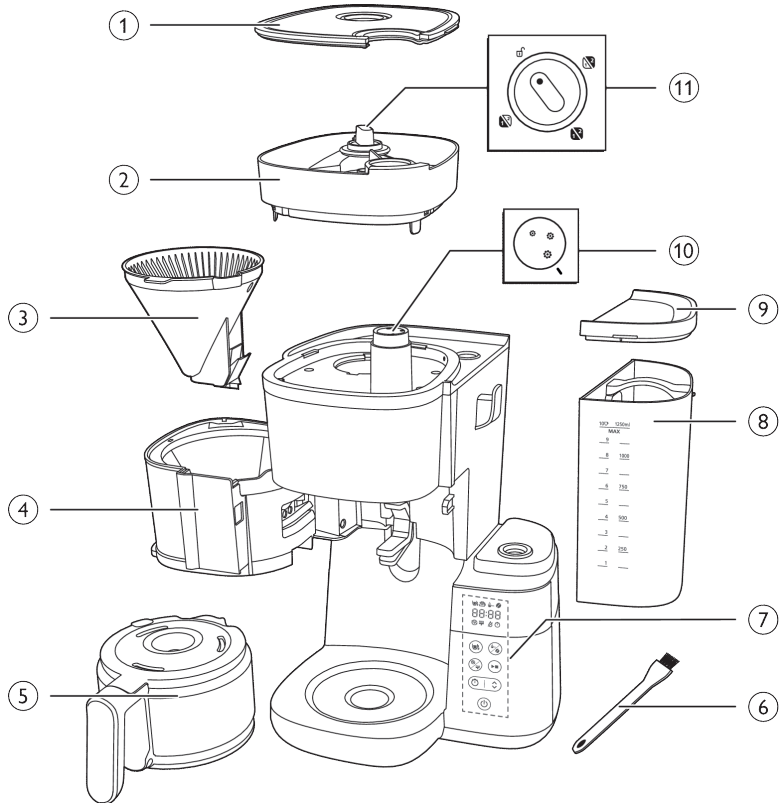

- 1 Tapa del recipiente de granos de café
- 2 Recipiente de granos de café
- 3 Cesta del filtro
- 4 Soporte de la cesta del filtro
- 5 Jarra de cristal
- 6 Cepillo de limpieza para el conducto de granos
- 7 Panel de control con pantalla
- 8 Depósito de agua
- 9 Tapa del depósito de agua
- 10 Botón de grado
- 11 Botón selector de contenedor

Panel de control



Botón de encendido



Botón del temporizador y botón de flecha para ajustar el tiempo



Botón de inicio/pausa



Botón de limpieza



Botón de café molido e intensidad del café



Botón de selección de tazas

Iconos de la pantalla



Número de tazas



Modo de conservación del calor



Café molido



Intensidad del café



Eliminación de los depósitos de cal



Alerta de limpieza manual



Nivel bajo del depósito de agua



Temporizador



Pantalla de hora

Los primeros dos dígitos representan las horas y los últimos dos dígitos representan los minutos.



Gire el botón selector hasta la posición de desbloqueo y, a continuación, podrá quitar los granos del aparato.



Este botón selecciona el grado de molido del café; un tamaño más grande que indica un molido más grueso.



Modo jarra

El modo jarra cuenta con la función antigoteo.

Nota: El proceso de preparación del café no se detiene cuando se retira la jarra. Si no vuelve a colocar la jarra en el aparato en un plazo de 20 segundos, la cesta del filtro comenzará a rebosar.



Modo taza

Cambie manualmente el botón selector del modo taza al modo jarra para abrir el sistema antigoteo y evitar que el café se derrame una vez que el ciclo de preparación haya terminado.

Nota: Si la taza de cerámica está fría robará el calor del café mientras se calienta; por lo tanto, caliente previamente la taza con agua caliente.

Importante

Warning

- Antes de enchufar el aparato, compruebe si el voltaje indicado en el mismo se corresponde con el voltaje de la red local.
- Conecte el aparato a un enchufe de pared con toma de tierra.
- No utilice el aparato si la clavija, el cable de alimentación o el propio aparato están dañados.
- Si el cable de alimentación está dañado, debe ser sustituido por Philips o por un centro de servicio autorizado por Philips u otro personal cualificado, con el fin de evitar situaciones de peligro.
- Este aparato puede ser usado por niños a partir de 8 años y por personas con su capacidad física, psíquica o sensorial reducida y por quienes no tengan los conocimientos y la experiencia necesarios, si han sido supervisados o instruidos acerca del uso del aparato de forma segura y siempre que sepan los riesgos que conlleva su uso. Los niños no deben llevar a cabo la limpieza ni el mantenimiento a menos que tengan más de 8 años o sean supervisados. Mantenga el aparato y el cable fuera del alcance de los niños menores de ocho años.
- No permita que los niños jueguen con el aparato.
- No deje que el cable de red cuelgue del borde de la mesa o encimera donde esté colocado el aparato.

- Para evitar posibles peligros o lesiones, nunca utilice este aparato para otros fines distintos a los previstos.

Caution

- Antes de usar el aparato por primera vez, enjuáguelo con agua limpia.
- No coloque el aparato sobre superficies calientes y no deje que el cable de alimentación entre en contacto con superficies calientes.
- No coloque el aparato dentro de un mueble mientras esté en uso.
- Desenchufe el aparato antes de limpiarlo y si surgen problemas durante su uso.
- Limpie siempre el aparato cuando se haya enfriado.
- Durante las fases de preparación y conservación del calor, el depósito de agua, el portafiltro, la placa caliente, la parte inferior del aparato y la jarra llena de café permanecen calientes incluso algún tiempo después.
- No coloque la jarra sobre el fuego ni en el microondas para recalentar el café.
- Este aparato está diseñado para utilizarlo en entornos domésticos o similares como: viviendas de granjas, hostales en los que se ofrecen desayunos, zona de cocina en tiendas, oficinas y otros entornos laborales, y por clientes de hoteles, moteles y entornos residenciales de otro tipo.
- Lleve siempre el aparato a un centro de servicio autorizado por Philips para su comprobación y reparación. No abra el aparato ni intente repararlo usted mismo.
- La superficie de la resistencia, el portafiltro, la parte inferior del aparato, la placa caliente y la jarra llena de café están sometidos a calor residual durante algún tiempo después de su uso.
- A menos que se indique lo contrario, todo el material de embalaje de la caja está fabricado con papel reciclado. Consulte la marca PAP de la caja.

Eliminación de los depósitos de cal

- Elimine los depósitos de cal de la cafetera cuando observe que aparece una alerta de eliminación de los depósitos de cal en la pantalla. Utilice solo vinagre blanco para eliminar los depósitos de cal, ya que otros productos pueden dañar el aparato.

Campos electromagnéticos (CEM)

Este aparato Philips cumple con los estándares sobre campos electromagnéticos (CEM).

Reciclaje



Este símbolo significa que este producto no debe desecharse con la basura normal del hogar (2012/19/UE).

Siga la normativa de su país con respecto a la recogida de productos eléctricos y electrónicos. El correcto desecho de los productos ayuda a evitar consecuencias negativas para el medioambiente y la salud humana.

A menos que se indique lo contrario, todo el material de embalaje de la caja está fabricado con papel reciclado. Consulte la marca PAP de la caja.

Garantía y asistencia

Versuni ofrece una garantía de dos años tras la compra de este producto. Esta garantía no es válida si un defecto se debe a un uso incorrecto o a un mantenimiento deficiente. Nuestra garantía no afecta a sus derechos bajo la ley como consumidor. Para obtener más información o hacer uso de la garantía, visite nuestro sitio web www.philips.com/support.

Antes de utilizarlo por primera vez

Asegúrese de limpiar el portafiltro y el filtro permanente después de cada uso.

Limpie bien el portafiltro con un paño seco después de cada uso. Asegúrese de limpiar cualquier acumulación de condensado.

Ajuste del reloj

- 1 Enchufe el aparato.
 - La pantalla de hora comenzará a parpadear.

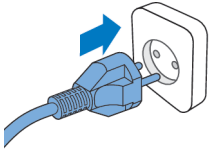

08:00



- 2 Utilice el botón de flecha para ajustar la hora.

08:



- 3 Una vez establecida la hora, pulse el botón del temporizador para confirmar la hora.

08:06



- 4 La indicación de minutos comenzará a parpadear. Utilice el botón de flecha para ajustar los minutos.

08:06



- 5 Pulse el botón del temporizador para confirmar los minutos.



08:06

- La hora actual ya está configurada y guardada.
- 6 Para ajustar el temporizador en el modo de espera, puede seguir uno de los dos métodos siguientes:
 - Apague y vuelva a enchufar el aparato.
 - Mantenga pulsado el botón del temporizador hasta que los dígitos de la hora comiencen a parpadear.

Nota

El aparato siempre guarda los últimos ajustes.

Tiempo de conservación del calor

Puede elegir cuánto tiempo desea que el café permanezca caliente después de la preparación. Para ello, ajuste el tiempo tras el cual el aparato se apagará automáticamente. El tiempo de apagado automático predeterminado es de 30 minutos. El tiempo de apagado automático máximo es de 300 minutos.

Para ajustar el tiempo de apagado automático, siga los pasos que se indican a continuación:

- 1 Apague el aparato y manténgalo enchufado.
- 2 Mantenga presionado el botón de limpieza hasta que se muestre el icono de conservación del calor y la hora comience a parpadear.
- 3 Siga el paso descrito en "Configuración del reloj" para completar el ajuste.

Limpieza del aparato antes de usarlo

Antes de usar la cafetera por primera vez, enjuague la cafetera siguiendo los pasos que se indican a continuación.

Advertencia: Nunca vierta agua en el contenedor de granos, ya que esto daña la cafetera.

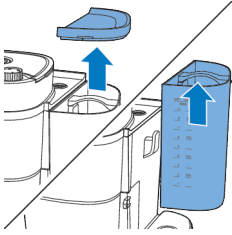

1 Abra la tapa del depósito de agua.

Precaución: No meta granos de café ni café molido en el depósito de agua.

2 Puede llenar el depósito de agua con agua de cualquiera de las siguientes formas:

- Levante el depósito y extráigalo del aparato y colóquelo debajo del grifo para llenarlo de agua.



- Asegúrese de que el gancho esté bien sujeto cuando lo vuelva a colocar.

- Sujete la pestaña de la tapa para levantar la tapa de la jarra. Coloque la jarra de café debajo del grifo para llenarla de agua. Llene el depósito de agua con la jarra de café.

- Asegúrese de que el agua no supere el nivel máximo.

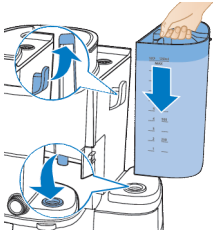

3 Cierre la tapa del depósito de agua.

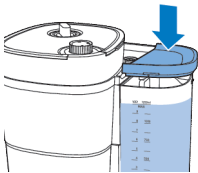

4 Coloque la jarra de café en el aparato.

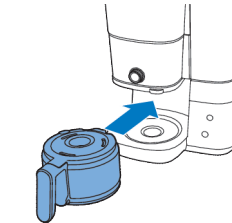

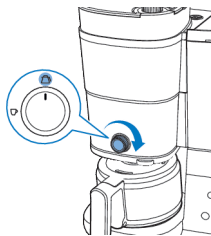

5 Gire la rueda central a la posición de la jarra.

10 3

6 Pulse el botón de encendido/apagado.

- El aparato se encenderá.



7 Pulse el botón de intensidad del café y seleccione café molido.

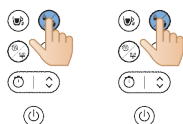

8 Pulse el botón de taza y seleccione 10 tazas.

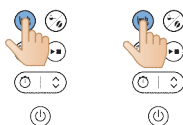

9 Pulse el botón de inicio.



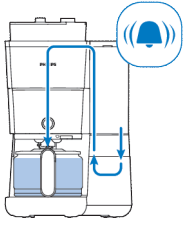

10 El aparato comenzará el proceso de aclarado.

11 Deje que el aparato funcione hasta que el proceso de aclarado haya terminado.



12 Vacíe la jarra de cristal.

Uso del aparato

Uso de los granos de café

Nota: La cafetera utilizará la cantidad necesaria de agua en función del número de tazas de café que se vayan a preparar.

Siga los pasos que se indican a continuación:

1 Abra la tapa del depósito de agua, levante el depósito y extráigalo del aparato.

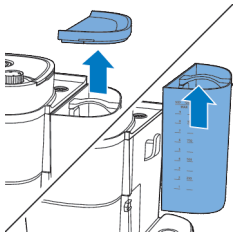

2 Llene el depósito con agua del grifo.

- Asegúrese de que el nivel de agua no supere el nivel máximo.



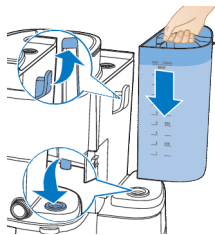

- 3 Vuelva a colocar el depósito en el aparato.
- Asegúrese de que el gancho esté bien colocado.

- 4 Cierre la tapa del recipiente de agua.

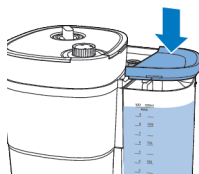

- 5 Levante la tapa del recipiente de granos de café.

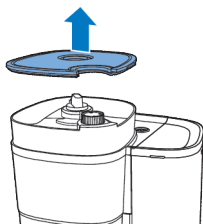

- 6 Añada los granos de café que desee al recipiente.

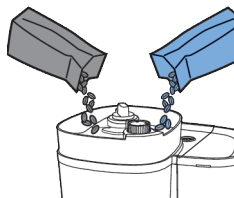

Nota: Asegúrese de que el recipiente de granos de café doble esté siempre lleno hasta la mitad.

Advertencia: Para evitar que el molinillo se atasque, no use granos sin tostar o caramelizados. Utilice granos de café en lugar de granos de espreso, ya que estos últimos pueden dañar el molinillo de café.

- 7 Cierre la tapa del contenedor de granos de café.

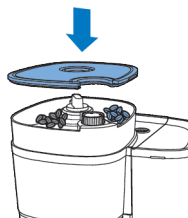

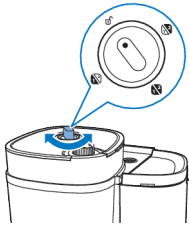

- 8** Gire el botón selector de contenedor para elegir los granos deseados entre los dos contenedores.
- Incluso puede mezclar dos tipos diferentes de granos para obtener una mezcla única.

Nota: Siempre que cambie de contenedor de granos de café o de granos de café, quedarán restos del tipo de granos de café molido anteriormente. Limpie la abertura del molinillo cuando vaya a cambiar a un nuevo tipo de grano de café para evitar esto.

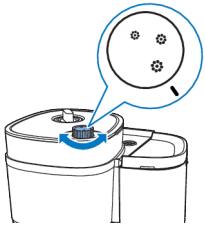

- 9** Elija el grado de molido deseado con el botón selector.

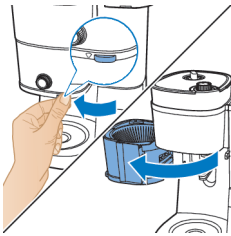

- 10** Sujete la pestaña para abrir el portafiltro.

- 11** Coloque un filtro de papel (tipo 1 x 4 o n.º 4) en la cesta del filtro.

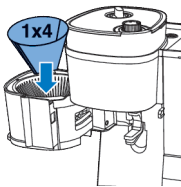

- 12** Cierre el portafiltro.

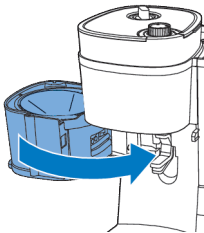

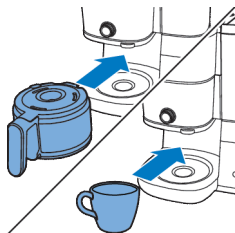

13 Coloque la jarra de café o la taza debajo del dispensador.

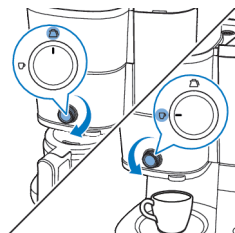

14 Utilice la rueda central para seleccionar la cantidad de café que desea preparar.

Cuando utilice la función de preparación en taza, puede usar tazas de cristal o cerámica, así como vasos. Asegúrese de usar vasos de menos de 10 cm de altura.

W 3



15 Encienda el aparato.

W 3



16 Pulse el botón de taza para seleccionar la cantidad de tazas que quiere preparar.

W 2



17 Pulse el botón de intensidad para elegir la intensidad del café que prefiera.

- 1: granos para café suave
- 2: granos para café de intensidad media-alta
- 3: granos para café fuerte



18 Pulse el botón de inicio/pausa para iniciar el proceso.

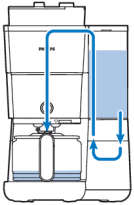

19 El aparato inicia el proceso.

- El aparato emitirá un pitido cuando haya terminado.

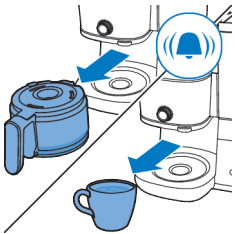

20 Retire la taza o la jarra de café del aparato.

La función antigoteo permite retirar la jarra de la cafetera antes de que finalice el proceso de preparación. Cuando retire la jarra, el sistema antigoteo detendrá el flujo de café en la jarra.

El proceso de preparación del café no se detiene cuando se retira la jarra. Si no vuelve a colocar la jarra en el aparato en un plazo de 20 segundos, la cesta del filtro comenzará a rebosar.



21 Disfrute de su café recién preparado.

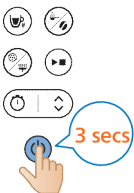

22 Para apagar el aparato, mantenga pulsado el botón de inicio/pausa durante tres segundos.

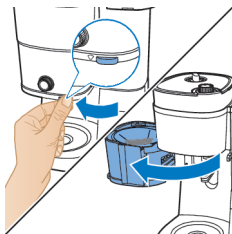

23 Abra el portafiltro.

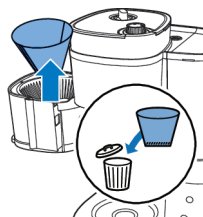

24 Retire el filtro de papel usado.

La función de conservación del calor no se activa cuando se preparan una o dos tazas.

El aparato mantendrá la bebida caliente hasta que se apague automáticamente. Si no quiere que la bebida siga caliente, pulse el botón de encendido para apagar el aparato.

Uso de café molido

Siga los pasos que se indican a continuación:

1 Compruebe que el aparato dispone de agua suficiente para preparar la cantidad de café deseada.

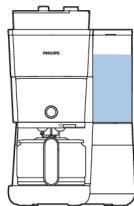

2 Sujete la pestaña para abrir el portafiltro.

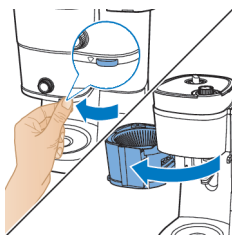

3 Coloque un filtro de papel (tipo 1 x 4 o n.º 4) en la cesta del filtro.

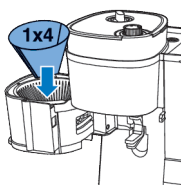

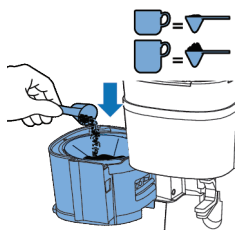

- 4 Añada la cantidad de café molido en el filtro de papel que utilice según sus preferencias personales.
- Para una taza de café estándar, utilice 6 gramos de café molido o 1 cucharada.

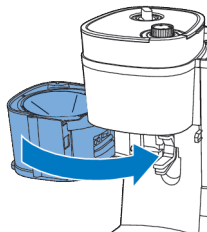

- 5 Cierre el portafiltro.

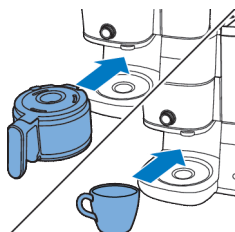

- 6 Coloque la jarra de café o la taza debajo del dispensador.

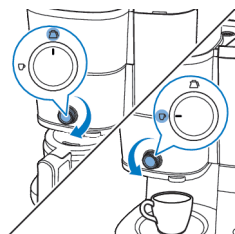

- 7 Utilice la rueda central para seleccionar la cantidad de café que desea preparar.

WS 10 3

- 8 Encienda el aparato.





9 Pulse el botón de selección de modo para usar café molido.

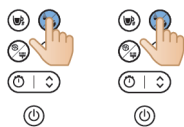

10 Pulse el botón de taza para seleccionar la cantidad de tazas que quiere preparar.

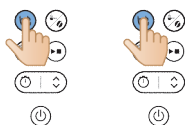

11 Pulse el botón de inicio/pausa para iniciar el proceso.



12 El aparato inicia el proceso.

- El aparato emitirá un pitido cuando haya terminado.

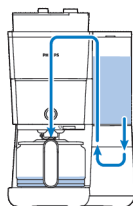

13 Retire la taza o la jarra de café del aparato.

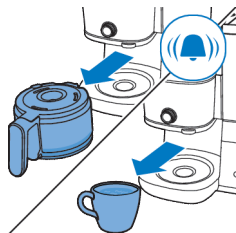



14 Disfrute de su café recién preparado.

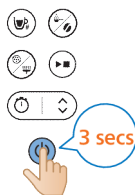

15 Para apagar el aparato, mantenga pulsado el botón de inicio/pausa durante tres segundos.

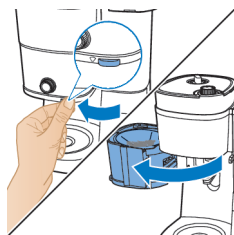

16 Abra el portafiltro.

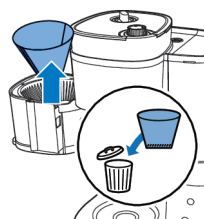

17 Retire el filtro de papel usado.

Ajuste del temporizador

Para ajustar el temporizador del aparato, siga estos pasos:

1 Encienda la cafetera.

08:05



- 2 Pulse el botón del temporizador y aparecerá el icono del temporizador en la pantalla. Los dígitos de la hora parpadean para indicar que está ajustando la hora.

08:00



- 3 Utilice el botón de flecha para ajustar las horas. Si necesita realizar un ajuste rápido, mantenga pulsado el botón de flecha.

08:



- 4 Pulse el botón del temporizador para confirmar la hora establecida. Los dígitos de los minutos indican que se están ajustando los minutos.

08:05



- 5 Vuelva a utilizar el botón de flecha para ajustar los minutos. Si necesita realizar un ajuste rápido, mantenga pulsado el botón de flecha.

08:05



- 6 Vuelva a pulsar el botón del temporizador para confirmar los minutos establecidos.

Para cancelar el temporizador, basta con pulsar el botón del temporizador y el icono del temporizador desaparecerá de la pantalla.

La función antigoteo permite retirar la jarra de la cafetera antes de que finalice el proceso de preparación. Cuando retire la jarra, el sistema antigoteo detendrá el flujo de café en la jarra.

Nota: El proceso de preparación del café no se detiene cuando se retira la jarra. Si no vuelve a colocar la jarra en el aparato en un plazo de 20 segundos, la cesta del filtro comenzará a rebosar.

Limpieza y mantenimiento

Limpieza después de cada uso

No sumerja nunca la cafetera en agua u otros líquidos, ni la enjuague debajo del grifo.

- 1 Desenchufe el aparato de la toma de corriente.

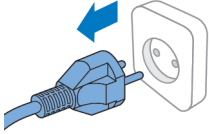





- 2 Limpie el exterior de la cafetera con un paño húmedo.
- 3 Lave la cesta del filtro con agua caliente y un poco de detergente líquido o en el lavavajillas.



- 4 Lave y enjuague la jarra de café y la tapa debajo del grifo. También puede lavarlos en el lavavajillas.

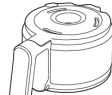
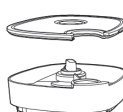
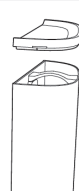

			
	✓	✓	✓
	✓	✓	✓
	✓	✓	✓
	✓	✗	✓
	✓	✗	✓

Limpieza de la abertura del molinillo

Importante:

Limpie la abertura del molinillo cada 1 o 2 semanas para evitar que se obstruya con café molido. Esta tarea es fácil y rápida si se siguen los pasos que se indican a continuación.

Limpie la abertura del molinillo cuando observe que aparece una alerta de cepillo en la pantalla.

Nota: Asegúrese de que el contenedor de granos de café esté vacío antes de comenzar con el procedimiento de limpieza.

- 1 Enchufe el aparato.

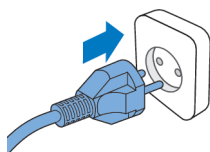

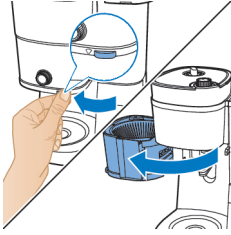

- 2** Abra el portafiltro para acceder al conducto de la abertura de entrada de café molido.

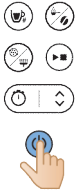

- 3** Encienda la cafetera.

- 4** Pulse el botón de limpieza en el panel de control del aparato.

- 5** Seleccione la configuración del cepillo en la pantalla.



- 6** Pulse el botón de inicio. Esto hará que la solapa del conducto de la abertura de entrada de café molido se abra, lo que le permitirá limpiar el conducto con un cepillo.

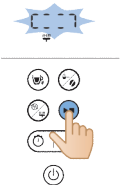

- 7** Utilice un cepillo para quitar cualquier poso o resto de café que se haya acumulado en el conducto.

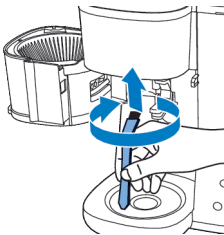



- 8 Después de limpiar el conducto, vuelva a pulsar el botón de inicio para cerrar la solapa.

Cómo eliminar la cal de la cafetera

Elimine los depósitos de cal de la cafetera cuando observe que aparece una alerta de eliminación de los depósitos de cal en la pantalla. Utilice solo vinagre blanco para eliminar los depósitos de cal, ya que otros productos pueden dañar la cafetera.

Advertencia: No utilice nunca vinagre con un 8 % de ácido acético o más, vinagre natural, desincrustantes en polvo ni en tabletas para eliminar la cal del aparato, ya que podría dañarlo.

- 1 Abra la tapa del depósito de agua.

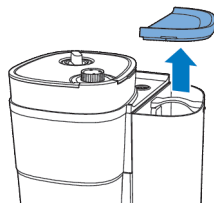

- 2 Llene el depósito de agua con vinagre blanco (4 % de ácido acético) hasta la indicación de 10 tazas.

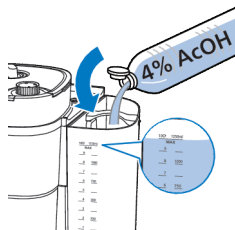

- 3** Cierre la tapa del recipiente de agua.

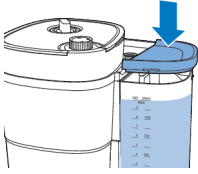

- 4** Sujete la pestaña para abrir el portafiltro.

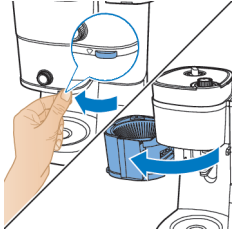

- 5** Coloque un filtro de papel (tipo 1 x 4 o n.º 4) en la cesta del filtro y cierre el soporte de la cesta del filtro.

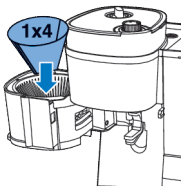

- 6** Coloque la jarra vacía en la cafetera.
7 Enchufe la clavija de red a la toma de corriente.

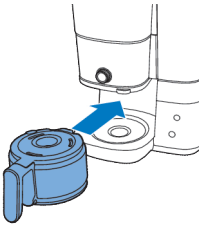

- 8** Pulse el botón de encendido para encender la cafetera. La pantalla se ilumina.

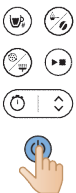

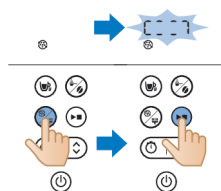

9 Pulse el botón de limpieza de la cafetera.

10 Seleccione el ajuste para eliminar la cal.

11 Pulse el botón de inicio para confirmar su selección.

- La cafetera iniciará automáticamente el proceso de eliminación de los depósitos de cal.

12 Espere a que la cafetera termine de preparar la solución descalcificante.

13 Una vez que el proceso de eliminación de los depósitos de cal se haya completado, enjuague la cafetera dos veces con la cantidad máxima de agua para eliminar completamente cualquier depósito.

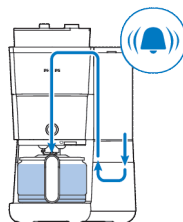

14 Vacíe la jarra y retire el filtro de papel con los restos de cal.

15 Llene el depósito de agua con agua fría y pulse el botón de inicio para comenzar otro proceso de preparación de café.

Deje que la cafetera complete el proceso de preparación de café y vacíe la jarra.

Nota: Si es necesario, repita el paso 14 hasta que el agua que salga del aparato no tenga sabor ni olor a vinagre.

16 Limpie la cesta del filtro y la jarra con agua caliente y algo de detergente líquido.

17 Pulse el botón de encendido para encender el aparato.

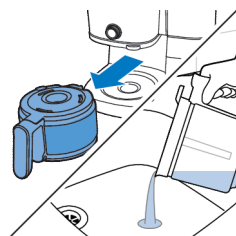

Solución de problemas

En este capítulo se resumen los problemas más comunes que podría tener con el aparato. Si no puede resolver el problema con la siguiente información, visite www.philips.com/support para consultar una lista de preguntas más frecuentes, o póngase en contacto con el servicio de atención al cliente en su país. También puede escanear este código QR para obtener más ayuda en línea.



Problema

La cafetera no funciona.

Solución

Conecte el enchufe a la toma de corriente y pulse el botón de encendido para encender la cafetera.

Compruebe que el voltaje indicado en la cafetera se corresponde con el voltaje de la red eléctrica local.

Llene el depósito de agua.

Cierre la tapa de la abertura del molinillo.

El molinillo no funciona o no hace correctamente.

Asegúrese de que no ha seleccionado café molido. Si el símbolo del café molido es visible en la pantalla, es que ha seleccionado café molido.

Siga las instrucciones para limpiar la abertura del molinillo.

Cuando utilizo el molinillo, el café es demasiado flojo.

Gire el botón de grado para seleccionar, de fino a grueso, el tipo de molido deseado.

Utilice el botón de selección de intensidad para establecer la intensidad del café del 1 al 3; cuanto mayor sea el dígito, mayor será la intensidad.

Utilice granos de café de una mezcla o un sabor más fuertes.

Cuando utilizo café molido, el café es demasiado flojo.

Asegúrese de que la cantidad de café molido del filtro coincide con la cantidad de agua del depósito de agua. Tenga en cuenta que la cafetera utiliza toda el agua del depósito.

Utilice café molido de una mezcla o un sabor más intenso.

Para aumentar la intensidad de café, aumente la cantidad de café molido o disminuya la cantidad de agua.

El filtro rebosa cuando retiro la jarra de la cafetera mientras se está preparando café.

Si retira la jarra durante más de 20 segundos durante el proceso de preparación de café, la función antigoteo hará que la cesta del filtro rebosa. También tenga en cuenta que el café no alcanza todo su sabor antes de que finalice el proceso de preparación. Por tanto, le recomendamos que no retire la jarra y vierta el café antes de que finalice el proceso de preparación.

La cafetera sigue goteando durante bastante tiempo después de finalizar el proceso de preparación del café.

El goteo lo causa la condensación de vapor. Es completamente normal que la cafetera gotee durante un tiempo.

No puedo esperar a las últimas gotas.

Cambie el botón del modo de taza a jarra para abrir la función antigoteo y el sistema antigoteo función detendrá el goteo de la cesta de filtro.

Si el goteo persiste, es posible que el sistema antigoteo esté obstruido. Para limpiar el sistema antigoteo, abra el soporte de la cesta del filtro y saque la cesta del filtro. Enjuague la cesta del filtro y el sistema antigoteo debajo del grifo.

El café no está lo suficientemente caliente.

El café de la jarra se enfría más rápido si prepara pocas tazas. El café permanece caliente durante más tiempo si prepara 10 tazas, una jarra llena.

Descalcifique la cafetera.

Los granos de café se consumen con demasiada rapidez.

Para preparar una taza de café perfecta, la cafetera necesita una cantidad determinada de café molido. La cantidad de granos de café que utiliza la cafetera para obtener la cantidad óptima de café molido por taza es normal.

El temporizador no funciona.

Asegúrese de completar todos los pasos para preparar café con granos de café o café molido antes de configurar el temporizador.

Código de error

Código de error	Descripción	Solución	Comentario
E1	Escasez de agua	Pulse cualquier botón para que el aparato pase al modo de espera. Rellene el depósito de agua y reinicie el aparato.	Si este problema persiste, siga estos pasos: Mantenga pulsados los botones de limpieza e inicio simultáneamente durante tres segundos hasta que el aparato comience a bombear agua automáticamente durante un minuto. Repita este proceso 3 veces más. Póngase en contacto con el servicio de atención al cliente si el problema persiste.
E2	Contenedor de granos no disponible	Pulse cualquier botón para que el aparato pase al modo de espera. Coloque el contenedor de granos de forma segura y reinicie el aparato.	Póngase en contacto con el servicio de atención al cliente si el problema persiste.
E3	Tubo de calentamiento averiado	Desenchufe el aparato. Vuelva a enchufar el aparato y enciéndalo cuando se enfríe por completo.	Póngase en contacto con el servicio de atención al cliente si el problema persiste.
E4	Bloqueo de la rueda de molido	Desenchufe el aparato. Vuelva a enchufar el aparato y enciéndalo. Siga los pasos que se indican en "Limpieza de la abertura del molinillo" para limpiar la rueda de molido y el conducto de la abertura de entrada de café molido.	Póngase en contacto con el servicio de atención al cliente si el problema persiste.

E5	Bloqueo del conducto de la abertura de entrada de café molido	Desenchufe el aparato. Vuelva a enchufar el aparato y enciéndalo. Siga los pasos que se indican en "Limpieza de la abertura del molinillo" para limpiar el conducto de la abertura de entrada de café molido.	Póngase en contacto con el servicio de atención al cliente si el problema persiste.
E6/E7/E8	Error de programa	Desenchufe el aparato. Vuelva a enchufar el aparato y enciéndalo.	Póngase en contacto con el servicio de atención al cliente si el problema persiste.

Introduction

Félicitations pour votre achat et bienvenue chez Philips !

Pour profiter pleinement de l'assistance offerte par Philips, enregistrez votre appareil à l'adresse suivante : www.philips.com/welcome.

Description générale

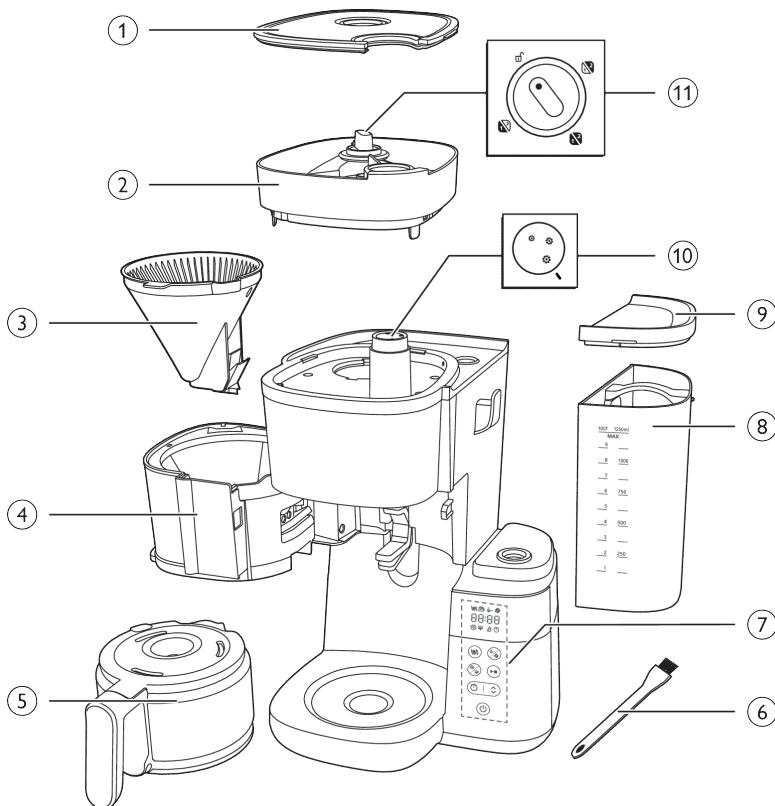

- 1 Couverture du bac à grains de café
- 2 Bac à grains de café
- 3 Porte-filtre
- 4 Support pour porte-filtre
- 5 Verseuse en verre
- 6 Brosse de nettoyage pour la goulotte du compartiment à grains de café
- 7 Panneau de commande avec afficheur
- 8 Réservoir d'eau
- 9 Couverture du réservoir d'eau
- 10 Sélecteur du broyeur
- 11 Sélecteur de bac

Panneau de commande



Bouton marche/arrêt



Bouton du programmateur et flèche pour régler l'heure



Bouton marche/pause



Bouton de nettoyage



Bouton d'intensité du café et bouton de café prémoulu



Bouton de sélection de la tasse

Icône de l'afficheur



Nombre de tasses



Mode Maintien au chaud



Café prémoulu



Intensité du café



Détartrage



Alerte de nettoyage manuel



Niveau d'eau faible



Minuteur



Horloge

Les deux premiers chiffres indiquent les heures et les deux derniers indiquent les minutes.



Tournez le sélecteur jusqu'à la position de déverrouillage et retirez le bac à grains de l'appareil.



Ce sélecteur permet de choisir la mouture du café : plus la taille sélectionnée est grande, plus la mouture sera grossière.



Mode Verseuse

La fonction stop-gouttes est disponible en mode Verseuse.

Remarque : Le cycle de préparation du café ne s'arrête pas lorsque vous retirez la verseuse. Si vous ne remplacez pas la verseuse dans l'appareil dans les 20 secondes qui suivent son retrait, le porte-filtre déborde.



Mode Tasse

Tournez manuellement le sélecteur du mode Tasse au mode Verseuse pour activer le système stop-gouttes afin d'empêcher la machine de goutter à la fin du cycle de préparation du café.

Remarque : Les tasses en céramique froide absorbent la chaleur du café. Nous vous conseillons donc de les passer sous l'eau chaude avant de les utiliser.

Important

Avertissement

- Avant de brancher l'appareil, vérifiez que la tension indiquée sur l'appareil correspond à la tension supportée par le secteur local.
- Branchez l'appareil sur une prise murale mise à la terre.
- N'utilisez jamais l'appareil si la prise, le cordon d'alimentation ou l'appareil lui-même est endommagé.
- Si le cordon d'alimentation est endommagé, il doit être remplacé par Philips, un Centre Service Agréé ou un technicien qualifié afin d'éviter tout accident.
- Cet appareil peut être utilisé par des enfants âgés de 8 ans ou plus, des personnes dont les capacités physiques, sensorielles ou intellectuelles sont réduites ou des personnes manquant d'expérience et de connaissances, à condition que ces enfants ou personnes soient surveillés ou aient reçu des instructions quant à l'utilisation sécurisée de l'appareil, et qu'ils aient pris connaissance des dangers encourus. Le nettoyage et l'entretien ne doivent pas être réalisés par des enfants sauf s'ils sont âgés de plus de 8 ans et sous surveillance. Tenez l'appareil et son cordon hors de portée des enfants de moins de 8 ans.
- Les enfants ne doivent pas jouer avec l'appareil.

- Ne laissez pas le cordon pendre de la table ou du plan de travail sur lequel l'appareil est posé.
- Pour éviter tout risque de blessure ou d'accident, n'utilisez pas l'appareil à d'autres fins que celles pour lesquelles il a été conçu.

Attention

- Avant la première utilisation, n'oubliez pas de rincer l'appareil à l'eau claire.
- Ne posez jamais l'appareil sur une surface chaude et veillez à ce que le cordon d'alimentation ne soit pas en contact avec des surfaces chaudes.
- Lorsque vous l'utilisez, ne placez pas l'appareil dans un meuble.
- Débranchez toujours l'appareil avant de le nettoyer et en cas de problème lors de la préparation du café.
- Attendez que l'appareil refroidisse avant de le nettoyer.
- Pendant la préparation et le maintien au chaud, le réservoir d'eau, le porte-filtre, la plaque chauffante, la partie inférieure de l'appareil et la verseuse remplie de café conservent la chaleur plusieurs minutes après l'utilisation.
- Ne mettez pas la verseuse sur une cuisinière ou dans un micro-ondes pour réchauffer votre café.
- Cet appareil est destiné à un usage domestique ou assimilé : utilisation dans des gîtes, chambres d'hôtes, cuisines destinées aux employés dans les magasins, les entreprises et autres environnements de travail, ou utilisation par les clients d'hôtels, d'auberges ou d'autres résidences hôtelières.
- Confiez toujours l'appareil à un Centre Service Agréé Philips pour réparation ou vérification. N'ouvrez pas l'appareil et n'essayez pas de le réparer vous-même.
- La surface de l'élément chauffant, le porte-filtre, la partie inférieure de l'appareil, la plaque chauffante et la verseuse remplie de café conservent la chaleur plusieurs minutes après l'utilisation.
- Sauf indication contraire, tous les matériaux d'emballage de la boîte sont en papier recyclé (voir l'indication de recyclage PAP sur la boîte).

Détartrage

- Lorsque l'alerte de détartrage apparaît sur l'afficheur, détartrez la machine à café. Pour ne pas endommager l'appareil lors du détartrage, utilisez uniquement du vinaigre blanc.

Champs électromagnétiques (CEM)

Cet appareil Philips est conforme aux normes relatives aux champs électromagnétiques (CEM).

Recyclage



Ce symbole signifie que ce produit ne doit pas être mis au rebut avec les ordures ménagères (2012/19/UE).

Respectez les règles en vigueur dans votre pays pour la mise au rebut des produits électriques et électroniques. Une mise au rebut correcte contribue à préserver l'environnement et la santé.

Sauf indication contraire, tous les matériaux d'emballage de la boîte sont en papier recyclé (voir l'indication de recyclage PAP sur la boîte).

Garantie et assistance

Versuni offre une garantie de deux ans à l'achat de ce produit. Cette garantie ne s'applique pas si le défaut est dû à une utilisation incorrecte ou à un manque d'entretien. Notre garantie ne porte pas atteinte à vos droits légaux en tant que consommateur. Pour plus d'informations ou pour faire valoir la garantie, rendez-vous sur notre site Web à l'adresse suivante : www.philips.com/support.

Avant la première utilisation

Après chaque utilisation, nettoyez le porte-filtre et le filtre permanent.

Après chaque utilisation, nettoyez soigneusement le porte-filtre avec un chiffon sec. Éliminez toute accumulation de condensation.

Réglage de l'horloge

- 1 Branchez l'appareil.
 - L'indicateur des heures clignote.

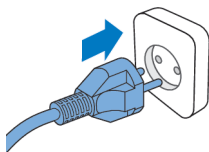

08:00

- 2 Appuyez sur la flèche pour modifier l'heure.



08:



- 3 Après avoir défini l'heure, appuyez sur le bouton du programmateur pour confirmer.



08:06

- 4 L'indicateur des minutes commence alors à clignoter. Appuyez sur la flèche pour modifier les minutes.



08:06



- 5 Appuyez sur le bouton du programmateur pour confirmer les minutes.



08:06

- L'heure a bien été réglée et enregistrée.
- 6 Pour régler le programmateur en mode veille, vous pouvez choisir l'une des deux approches ci-dessous :
- Débranchez l'appareil et rebranchez-le.
 - Maintenez le bouton du programmateur enfoncé jusqu'à ce que les chiffres des heures clignotent.

Remarque

L'appareil enregistre toujours le dernier réglage sélectionné.

Durée du maintien au chaud

Réglez le délai de mise hors tension automatique de l'appareil pour choisir la durée pendant laquelle vous souhaitez que votre café reste chaud après la préparation. Par défaut, le délai de mise hors tension automatique est de 30 minutes. Le délai maximum de mise hors tension automatique est de 300 minutes.

Pour régler le délai avant la mise hors tension automatique, suivez les étapes ci-dessous :

- 1 Éteignez l'appareil et laissez-le branché.
- 2 Appuyez sur le bouton de nettoyage et maintenez-le enfoncé jusqu'à ce que l'icône de maintien au chaud s'affiche et que l'heure clignote.

- 3 Pour terminer le réglage, suivez les étapes de la section « Réglage de l'horloge ».

Rinçage de l'appareil

Avant la première utilisation, n'oubliez pas de rincer la cafetière à l'eau claire conformément aux instructions ci-dessous.

Avertissement : Pour ne pas endommager la cafetière, ne versez pas d'eau dans le bac à grains.

- 1 Ouvrez le couvercle du réservoir d'eau.

Attention : Ne mettez pas de grains de café ou de café moulu dans le réservoir d'eau.

- 2 Pour remplir le réservoir d'eau, utilisez l'une des méthodes suivantes :

- Retirez le réservoir de l'appareil et remplissez-le au robinet.

- Lorsque vous le remettez en place, assurez-vous que le crochet est bien fixé.
- Saisissez la languette du couvercle pour retirer le couvercle de la verseuse. Placez la verseuse sous le robinet pour la remplir d'eau. Remplissez le réservoir d'eau avec la verseuse.
- Assurez-vous que le niveau d'eau soit inférieur au niveau maximal.

- 3 Fermez le couvercle du réservoir d'eau.

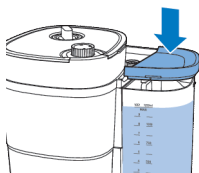
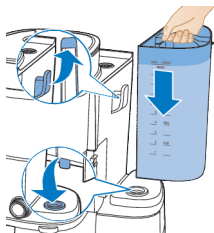
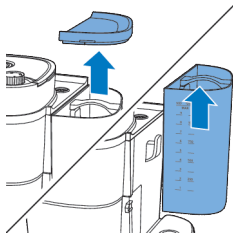

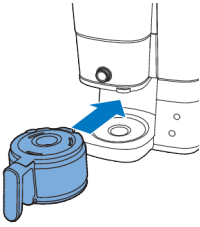

4 Placez la verseuse dans l'appareil.

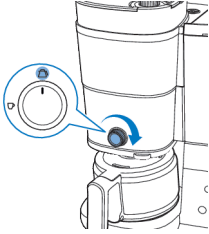

5 Tournez le sélecteur central pour sélectionner le mode Verseuse.



6 Appuyez sur le bouton marche/arrêt.
- L'appareil est allumé.



7 Appuyez sur le bouton d'intensité du café et sélectionnez Café prémoulu.

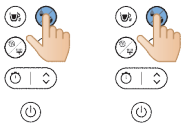

8 Appuyez sur le bouton de tasse et sélectionnez 10 tasses.

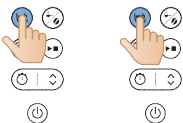



9 Appuyez sur le bouton marche/arrêt.

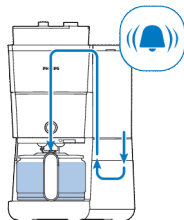

10 La machine lance le cycle de rinçage.

11 Laissez l'appareil fonctionner jusqu'à ce que le processus de rinçage soit terminé.



12 Videz la verseuse en verre.

Utilisation de l'appareil

Utilisation avec des grains de café

Remarque : la quantité d'eau utilisée par la machine à café dépend du nombre de tasses à préparer.

Suivez les étapes ci-dessous pour utiliser ce type de café :

1 Ouvrez le couvercle du réservoir d'eau et retirez-le de l'appareil.

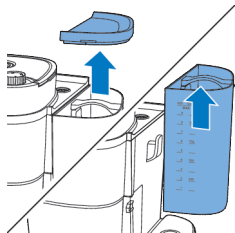



- 2 Remplissez le réservoir avec de l'eau du robinet.
- Assurez-vous que le niveau d'eau soit inférieur au niveau maximal.

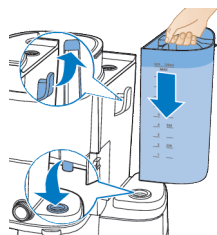

- 3 Remplacez le réservoir dans l'appareil.
- Assurez-vous que le crochet est bien fixé.

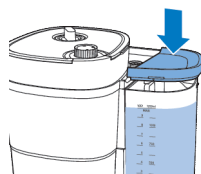

- 4 Fermez le couvercle du bac d'eau.

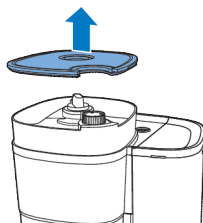

- 5 Soulevez le couvercle du bac à grains.

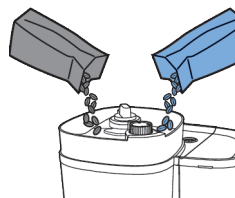

- 6 Remplissez le bac avec les grains de café de votre choix.

Remarque : À chaque utilisation, vérifiez que le bac à grains est au moins à moitié rempli.

Avertissement : N'utilisez pas de grains de café caramélisés ou non torréfiés, cela risquerait d'entraver le bon fonctionnement du broyeur. Utilisez des grains de café plutôt que des grains d'espresso pour éviter d'endommager le broyeur.

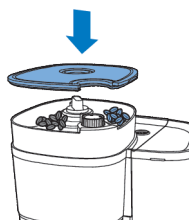

7 Fermez le couvercle du bac à grains.

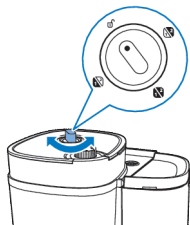

8 Tournez le sélecteur de bac pour choisir le bac à grains à utiliser parmi les deux bacs disponibles.

- Pour obtenir un mélange unique, vous pouvez même associer deux types de grains différents.

Remarque : Chaque fois que vous changez le bac à grains ou le type de café utilisé, vous observerez forcément des traces du café précédent. Pour éviter cela, nettoyez l'entonnoir du broyeur après avoir sélectionné un nouveau type de grains de café.

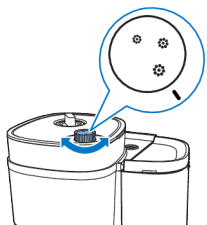

9 Choisissez le niveau de mouture souhaité à l'aide du sélecteur.

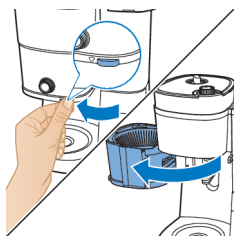

10 Ouvrez le porte-filtre à l'aide de la languette.

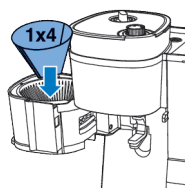

11 Placez un filtre en papier (type 1 x 4 ou n° 4) dans le porte-filtre.

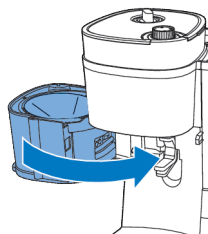

12 Fermez le porte-filtre.

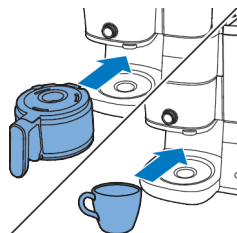

13 Placez la verseuse ou la tasse sous le distributeur.

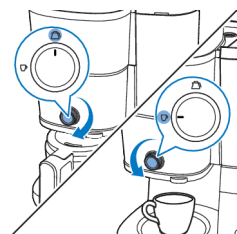

14 Utilisez le sélecteur pour définir la quantité de café à préparer.

Lorsque vous utilisez la fonctionnalité de préparation à la tasse, vous pouvez utiliser des tasses en verre ou en céramique, ou des verres. Dans tous les cas, le contenant ne doit pas mesurer plus de 10 cm de hauteur.



15 Mettez l'appareil sous tension.



16 Appuyez sur le bouton de tasse pour sélectionner le nombre de tasses à préparer.





17 Appuyez sur le bouton d'intensité pour choisir l'intensité du café.

- 1 : Grains pour café doux
- 2 : grains pour café relativement fort
- 3 : grains pour café fort



18 Démarrez le processus en appuyant sur le bouton marche/pause.



19 L'appareil démarre.

- À la fin du processus, l'appareil émet un signal sonore.

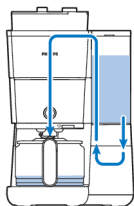

20 Retirez la tasse ou la verseuse de l'appareil.

La fonction stop-gouttes vous permet de retirer la verseuse de la cafetière avant la fin du cycle de préparation du café. Lorsque vous retirez la verseuse, le système stop-gouttes interrompt l'écoulement.

Le cycle de préparation du café ne s'arrête pas lorsque vous retirez la verseuse. Si vous ne remplacez pas la verseuse dans l'appareil dans les 20 secondes qui suivent son retrait, le porte-filtre déborde.

21 Savourez votre café fraîchement préparé.

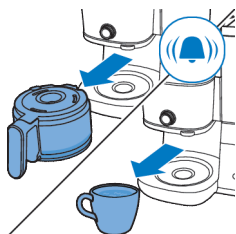



22 Pour éteindre l'appareil, maintenez le bouton « marche/pause » enfoncé pendant trois secondes.

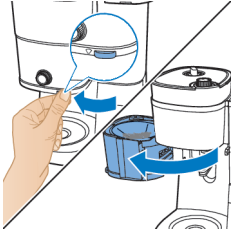

23 Ouvrez le porte-filtre.

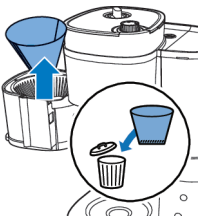

24 Retirez le filtre en papier usagé.

Le mode Maintien au chaud ne s'active pas lors de la préparation d'une ou deux tasses.

Lorsqu'elle est sur l'appareil, la boisson est maintenue au chaud jusqu'à ce que la cafetière s'éteigne. Si vous souhaitez interrompre le maintien au chaud, appuyez sur le bouton marche/arrêt pour éteindre l'appareil.

Utilisation avec du café prémoulu

Suivez les étapes ci-dessous pour utiliser ce type de café :

1 Avant de lancer la préparation de café, vérifiez que le niveau d'eau est suffisant.



2 Ouvrez le porte-filtre à l'aide de la languette.

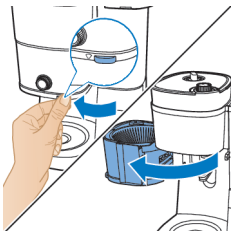

3 Placez un filtre en papier (type 1 x 4 ou n° 4) dans le porte-filtre.

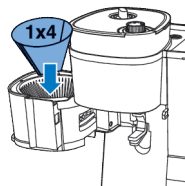

4 Ajoutez la quantité de café prémoulu désirée dans le filtre en papier.
- Pour une tasse de café standard, utilisez 6 grammes de café moulu ou 1 cuillère à soupe.

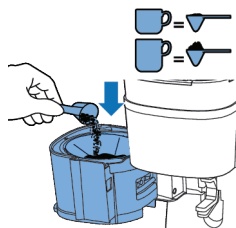

5 Fermez le porte-filtre.

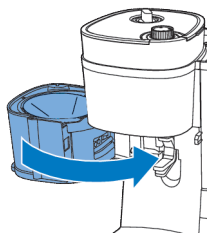

6 Placez la verseuse ou la tasse sous le distributeur.

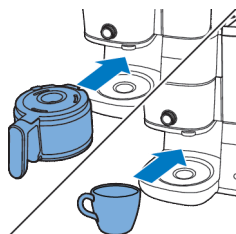

7 Utilisez le sélecteur pour définir la quantité de café à préparer.

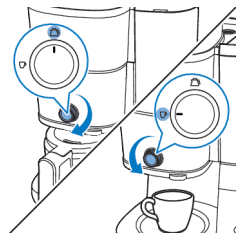

☰ 3



8 Mettez l'appareil sous tension.



9 Choisissez l'utilisation de café prémoulu à l'aide du bouton de sélection de mode.



10 Appuyez sur le bouton de tasse pour sélectionner le nombre de tasses à préparer.

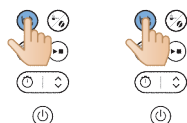

11 Démarrez le processus en appuyant sur le bouton marche/pause.



12 L'appareil démarre.

- À la fin du processus, l'appareil émet un signal sonore.

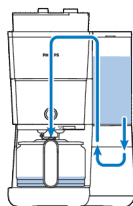

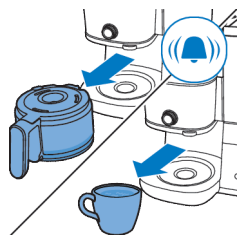

13 Retirez la tasse ou la verseuse de l'appareil.



14 Savourez votre café fraîchement préparé.



15 Pour éteindre l'appareil, maintenez le bouton « marche/pause » enfoncé pendant trois secondes.

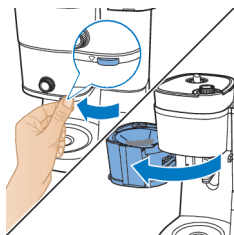

16 Ouvrez le porte-filtre.

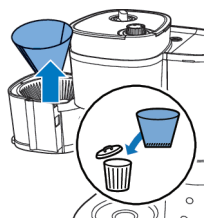

17 Retirez le filtre en papier usagé.

Réglage du programmateur

Pour régler le programmateur de l'appareil, procédez comme suit :

- 1 Allumez la machine à café.
- 2 Appuyez sur le bouton du programmateur ; l'icône du programmateur s'affiche. Les chiffres des heures clignotent pour indiquer le réglage des heures.
- 3 Appuyez sur la flèche pour modifier les heures. Pour effectuer un réglage rapide, appuyez longuement sur la flèche.
- 4 Appuyez sur le bouton du programmateur pour confirmer l'heure. Les chiffres des minutes indiquent le réglage des minutes.
- 5 Appuyez à nouveau sur la flèche pour modifier les minutes. Pour effectuer un réglage rapide, appuyez longuement sur la flèche.

08:06



08:00



08:



08:06



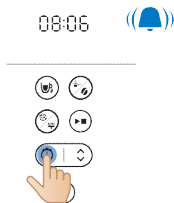

6 Appuyez sur le bouton du programmateur pour confirmer les minutes.

Pour annuler le programmateur, appuyez simplement sur le bouton du programmateur ; l'icône du minuteur s'affiche.

La fonction stop-gouttes vous permet de retirer la verseuse de la cafetière avant la fin du cycle de préparation du café. Lorsque vous retirez la verseuse, le système stop-gouttes interrompt l'écoulement.

Remarque : Le cycle de préparation du café ne s'arrête pas lorsque vous retirez la verseuse. Si vous ne remplacez pas la verseuse dans l'appareil dans les 20 secondes qui suivent son retrait, le porte-filtre déborde.

Nettoyage et entretien

Nettoyage après chaque utilisation

Ne plongez jamais la machine à café dans l'eau ou dans d'autres liquides, et ne la rincez pas sous l'eau.

1 Retirez le cordon d'alimentation de la prise secteur.

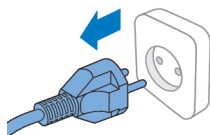









2 Nettoyez l'extérieur de la machine à café à l'aide d'un chiffon humide.

3 Nettoyez le porte-filtre à l'eau chaude avec un peu de produit vaisselle, ou passez-le au lave-vaisselle.



4 Nettoyez la verseuse et son couvercle en les passant sous l'eau. Vous pouvez également les mettre au lave-vaisselle.

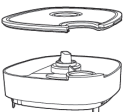

			
	✓	✓	✓
	✓	✓	✓
	✓	✓	✓
	✓	✗	✓
	✓	✗	✓

Nettoyage de l'entonnoir du broyeur

Important :

Pour éviter que l'entonnoir du broyeur ne se retrouve obstrué par du café moulu, nettoyez-le toutes les 1 à 2 semaines. Suivez les étapes ci-dessous pour un nettoyage rapide et facile.

Lorsque l'alerte de la brosse s'affiche, nettoyez l'entonnoir du broyeur.

Remarque : Avant de lancer le processus de nettoyage, videz le bac à grains.

1 Branchez l'appareil.

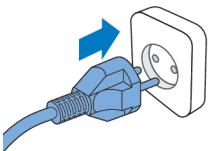

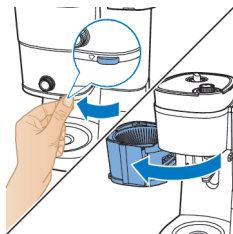

2 Ouvrez le porte-filtre pour accéder à la goulotte de l'entonnoir du broyeur.

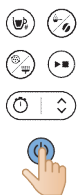

3 Allumez la machine à café.

4 Appuyez sur le bouton de nettoyage du panneau de commande de la cafetière.

5 Sur l'afficheur, sélectionnez la brosse.



6 Appuyez sur le bouton marche/arrêt. La trappe de la goulotte de l'entonnoir du broyeur s'ouvre ; vous pouvez alors nettoyer la goulotte avec une brosse.

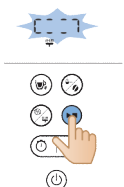

7 Utilisez une brosse pour éliminer le marc de café ou les résidus accumulés dans la goulotte.

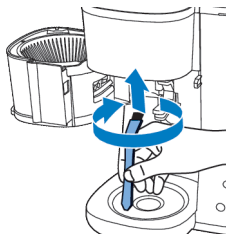



- 8 Après avoir nettoyé la goulotte, appuyez de nouveau sur le bouton marche/arrêt pour fermer la trappe.



Détartrage de la machine à café

Lorsque l'alerte de détartrage apparaît sur l'afficheur, détartrez la machine à café. Pour ne pas endommager la machine à café lors du détartrage, utilisez uniquement du vinaigre blanc.

Avertissement : Afin d'éviter tout dommage, n'utilisez jamais de vinaigre blanc à teneur en acide acétique supérieure ou égale à 8 %, de vinaigre naturel ou de détartrant en poudre ou en tablette pour détartrer l'appareil.

- 1 Ouvrez le couvercle du réservoir d'eau.

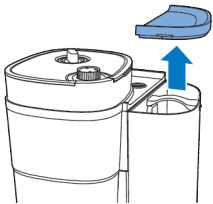

- 2 Remplissez le réservoir d'eau avec du vinaigre blanc (4 % d'acide acétique) jusqu'à l'indication « 10 tasses ».

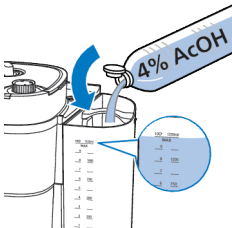

3 Fermez le couvercle du bac d'eau.

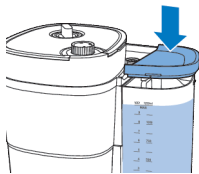

4 Ouvrez le porte-filtre à l'aide de la languette.

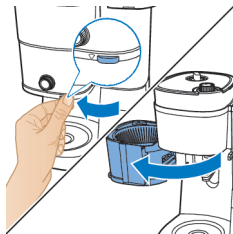

5 Placez un filtre en papier (type 1 x 4 ou n° 4) dans le porte-filtre et fermez le support pour porte-filtre.

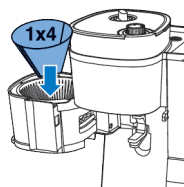

6 Placez la verseuse vide dans la machine à café.

7 Branchez le cordon d'alimentation sur la prise secteur.

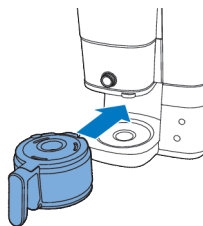

8 Appuyez sur le bouton marche/arrêt pour allumer la machine à café.
L'afficheur s'allume.

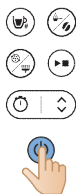

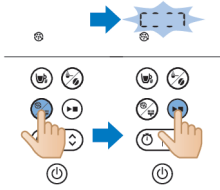

- 9 Appuyez sur le bouton de nettoyage de la machine à café.
- 10 Sélectionnez l'option Détartrage.
- 11 Appuyez sur le bouton marche/arrêt pour confirmer votre sélection.
 - Le détartrage de la machine à café se lance automatiquement.

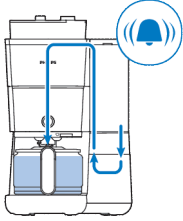

- 12 Attendez que l'appareil finisse d'éliminer la solution de détartrage.
- 13 Après le détartrage, rincez l'appareil au moins deux fois en remplissant le réservoir au maximum pour éliminer complètement les dépôts.

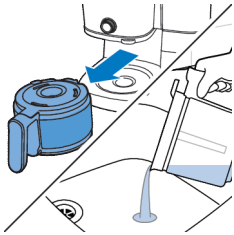

- 14 Videz la verseuse et retirez le filtre en papier contenant les résidus de calcaire.
- 15 Remplissez le réservoir d'eau avec de l'eau froide et appuyez sur le bouton marche/arrêt pour démarrer un nouveau cycle de préparation du café. Laissez la machine à café terminer le cycle de préparation du café et videz la verseuse.

Remarque : Si nécessaire, répétez l'étape 14 jusqu'à ce que l'eau s'écoulant de la machine à café n'ait plus le goût ni l'odeur du vinaigre.

- 16 Nettoyez le porte-filtre et la verseuse à l'eau chaude avec un peu de liquide vaisselle.
- 17 Appuyez sur le bouton marche/arrêt pour éteindre l'appareil.

Dépannage

Cette rubrique présente les problèmes les plus courants que vous pouvez rencontrer avec votre machine. Si vous ne parvenez pas à résoudre le problème à l'aide des informations ci-dessous, rendez-vous sur www.philips.com/support pour consulter les questions fréquemment posées ou contactez le Service Consommateurs de votre pays.

Pour obtenir une assistance en ligne supplémentaire, scannez ce QR code.



Problème

La machine à café ne fonctionne pas.

Solution

Branchez le cordon d'alimentation sur une prise secteur, puis appuyez sur le bouton marche/arrêt pour allumer la machine à café.

Assurez-vous que la tension indiquée sur la machine à café correspond bien à la tension secteur locale.

Remplissez le réservoir d'eau.

Fermez le couvercle de l'entonnoir du broyeur.

Le broyeur ne fonctionne pas ou ne fonctionne pas correctement.

Assurez-vous que vous n'avez pas sélectionné l'option Café prémoulu. Si le symbole de café prémoulu est affiché, vous avez sélectionné l'option Café prémoulu.

Nettoyez l'entonnoir du broyeur en suivant les instructions.

Lorsque j'utilise le broyeur, le café est trop léger.

Tournez le sélecteur de mouture pour sélectionner le type de mouture souhaité (fine ou grossière).

Utilisez le bouton de sélection de l'intensité pour ajuster l'intensité du café sur une échelle de 1 à 3 ; le chiffre le plus élevé correspond à une intensité plus forte.

Utilisez des grains de café à l'arôme plus intense ou au goût plus fort.

Lorsque j'utilise du café prémoulu, le café est trop léger.

Assurez-vous que la quantité de café prémoulu dans le filtre correspond à la quantité d'eau dans le réservoir d'eau. N'oubliez pas que la machine à café utilise toute l'eau du réservoir.

Utilisez un café moulu à l'arôme plus intense ou au goût plus fort.

Pour plus d'intensité, augmentez la quantité de café prémoulu ou diminuez la quantité d'eau.

Le filtre déborde lorsque je retire la verseuse de la machine à café au cours d'un cycle de préparation du café.

Si vous retirez la verseuse pendant plus de 20 secondes pendant le cycle de préparation du café, le système stop-gouttes fait déborder le porte-filtre. Notez également que le café ne libère pas tous ses arômes tant que le cycle de préparation n'est pas terminé. Nous vous conseillons donc de ne pas retirer la verseuse de l'appareil et de ne pas vous servir avant la fin du cycle de préparation du café.

La machine à café continue à goutter longtemps après la fin du cycle de préparation du café.

La formation de gouttes est liée à la condensation de la vapeur. Il est tout à fait normal que la machine à café goutte pendant un certain temps.

Vous ne voulez pas attendre ?

Avec le sélecteur, passez du mode Tasse au mode Verseuse pour activer la fonction stop-gouttes et empêcher le porte-filtre de goutter.

Si des gouttes continuent à couler, il se peut que le système stop-gouttes soit obstrué. Pour nettoyer le système stop-gouttes, ouvrez le support pour porte-filtre et sortez le porte-filtre. Rincez le porte-filtre et le système stop-gouttes à l'eau claire.

Le café n'est pas assez chaud.

Lorsque vous ne préparez que quelques tasses, le café refroidit plus rapidement dans la verseuse. Lorsque vous préparez 10 tasses, soit une verseuse complète, le café reste chaud plus longtemps.

Détartrez votre machine à café.

Les grains de café semblent avoir été utilisés rapidement.	Pour préparer la tasse de café parfaite, votre machine à café a besoin d'une certaine quantité de café moulu. La machine à café utilise une quantité normale de grains de café pour obtenir une tasse de qualité optimale.
Le programmeur ne fonctionne pas.	Avant de régler le programmeur, suivez chaque étape du cycle de préparation du café, que ce soit avec des grains de café ou du café prémoulu.

Code d'erreur

Code d'erreur	Description	Solution	Remarque
E1	Quantité d'eau insuffisante	Appuyez sur n'importe quel bouton pour mettre l'appareil en mode veille. Remplissez le réservoir et redémarrez l'appareil.	Si le problème persiste, procédez comme suit : Maintenez le bouton de nettoyage et le bouton marche/arrêt enfoncés pendant trois secondes ou jusqu'à ce que l'appareil commence à pomper l'eau pendant une minute. Répétez cette opération 3 fois. Si le problème persiste, contactez le service clientèle.
E2	Bac à grains indisponible	Appuyez sur n'importe quel bouton pour mettre l'appareil en mode veille. Fixez correctement le bac à grains et redémarrez l'appareil.	Si le problème persiste, contactez le service clientèle.
E3	Dysfonctionnement du tube chauffant	Débranchez l'appareil. Rebranchez l'appareil et remettez-le sous tension jusqu'à ce qu'il refroidisse complètement.	Si le problème persiste, contactez le service clientèle.
E4	Blocage de la meule	Débranchez l'appareil. Rebranchez l'appareil et remettez-le sous tension. Suivez les étapes de la rubrique « Nettoyage de l'entonnoir du broyeur » pour nettoyer la meule et la goulotte de l'entonnoir du broyeur.	Si le problème persiste, contactez le service clientèle.
E5	Obstruction de la goulotte de l'entonnoir du broyeur	Débranchez l'appareil. Rebranchez l'appareil et remettez-le sous tension. Suivez les étapes de la rubrique « Nettoyage de l'entonnoir du broyeur » pour nettoyer la goulotte de l'entonnoir du broyeur.	Si le problème persiste, contactez le service clientèle.
E6/E7/E8	Erreur programme	Débranchez l'appareil. Rebranchez l'appareil et remettez-le sous tension.	Si le problème persiste, contactez le service clientèle.

Introduzione

Congratulazioni per l'acquisto e benvenuti in Philips.

Per trarre il massimo vantaggio dall'assistenza fornita da Philips, registrare il proprio prodotto sul sito www.philips.com/welcome.

Descrizione generale

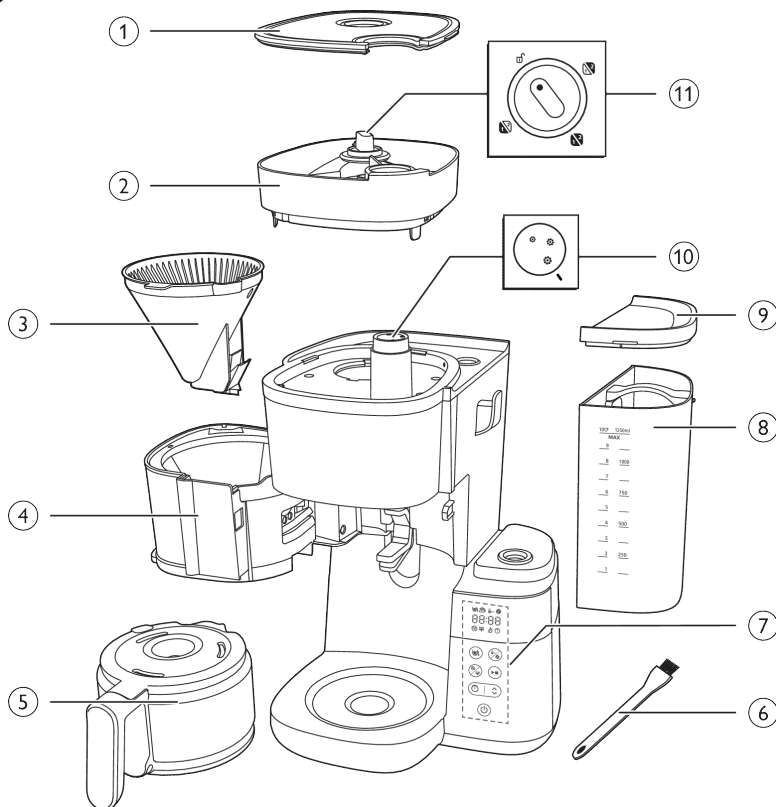

- 1 Coperchio del contenitore dei chicchi di caffè
- 2 Contenitore dei chicchi di caffè
- 3 Cestello del filtro
- 4 Supporto del cestello del filtro
- 5 Caraffa di vetro
- 6 Spazzolina per la pulizia dello scivolo dei chicchi di caffè
- 7 Pannello di controllo con display
- 8 Serbatoio dell'acqua
- 9 Coperchio del serbatoio dell'acqua
- 10 Manopola di regolazione della macinatura
- 11 Manopola di selezione del contenitore

Pannello di controllo



Pulsante di accensione

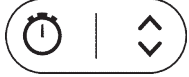

Pulsante del timer e pulsante freccia per la regolazione dell'ora



Pulsante di avvio/pausa



Pulsante per la pulizia



Pulsante pre-macinato e per l'intensità del caffè



Pulsante di selezione delle tazze

Icona del display



Numero di tazze



Modalità mantenimento della temperatura



Caffè pre-macinato



Intensità del caffè



Rimozione del calcare



Avviso di pulizia manuale



Riserva di acqua insufficiente



Timer



Visualizzazione dell'ora

Le prime due cifre rappresentano le ore, mentre le ultime due rappresentano i minuti.



Ruotare la manopola in posizione di sblocco, quindi rimuovere il contenitore dei chicchi di caffè dall'apparecchio.



Questa manopola consente di selezionare la macinatura del caffè; le dimensioni maggiori indicano una macinatura più grossolana.



Modalità caraffa

La modalità caraffa offre la funzione antigoccia.

Nota: il processo di erogazione non si interrompe quando viene rimossa la caraffa. Se la caraffa non viene riposizionata nell'apparecchio entro 20 secondi, il caffè fuoriesce dal cestello del filtro.



Modalità tazza

Spostare manualmente la manopola dalla modalità caraffa per attivare la funzione antigoccia ed evitare sgocciolamenti una volta terminato il ciclo di erogazione.

Nota: una tazza in ceramica fredda assorbe calore sottraendolo al caffè; utilizzare una tazza preriscaldata con acqua calda.

Importante

Avviso

- Prima di collegare l'apparecchio, verificare che la tensione riportata sull'apparecchio corrisponda alla tensione di rete locale.
- Collegare l'apparecchio a una presa a muro con messa a terra.
- Non utilizzare l'apparecchio se la spina, il cavo di alimentazione o l'apparecchio stesso presenta danni.
- Se il cavo di alimentazione è danneggiato deve essere sostituito da Philips, da un centro di assistenza autorizzato Philips o da persone qualificate al fine di evitare possibili danni.
- Questo apparecchio può essere usato da bambini a partire dagli 8 anni in su e da persone con capacità mentali, fisiche o sensoriali ridotte, prive di esperienza o conoscenze adatte, a condizione che abbiano ricevuto assistenza o formazione per utilizzare l'apparecchio in maniera sicura e siano consapevoli dei potenziali pericoli associati a tale uso. Le operazioni di pulizia e manutenzione possono essere effettuate solo da bambini di età superiore a 8 anni e sotto la supervisione di un adulto. Tenere l'apparecchio e il relativo cavo lontani dalla portata di bambini di età inferiore a 8 anni.
- Evitare che i bambini giochino con l'apparecchio.
- Assicurarsi che il cavo di alimentazione non penda dal bordo del tavolo o dal piano di lavoro su cui è posizionato l'apparecchio.

- Utilizzare questo apparecchio esclusivamente per lo scopo previsto onde evitare possibili lesioni.

Attenzione

- Pulire sempre l'apparecchio con acqua pulita prima di utilizzarlo per la prima volta.
- Non appoggiare l'apparecchio su una superficie calda ed evitare che il cavo di alimentazione venga a contatto con superfici incandescenti.
- Non posizionare l'apparecchio all'interno di un mobiletto durante l'uso.
- Scollegare l'apparecchio dalla presa di corrente prima di pulirlo e se si verificano problemi durante la preparazione del caffè.
- Pulire sempre l'apparecchio quando si è raffreddato.
- Durante l'erogazione e il mantenimento della temperatura, il serbatoio dell'acqua, il portafiltro, la piastra, la parte inferiore dell'apparecchio e la caraffa piena di caffè rimangono caldi per un certo periodo.
- Non posizionare la caraffa su un piano cottura o nel microonde per riscaldare il caffè.
- Questo apparecchio è stato progettato per essere utilizzato in casa e in ambienti simili, ad esempio agriturismi, ambienti del tipo bed and breakfast, aree ristoro per il personale di negozi, uffici e altri ambienti di lavoro, nonché dagli ospiti in hotel, motel e altri luoghi residenziali analoghi.
- Per eventuali controlli o riparazioni, rivolgersi sempre a un centro autorizzato Philips. Non aprire o tentare di riparare l'apparecchio da soli.
- La superficie della resistenza, il portafiltro, la parte inferiore dell'apparecchio, la piastra e la caraffa piena di caffè mantengono calore residuo per un certo periodo di tempo dopo l'uso.
- Se non diversamente specificato, tutto il materiale di imballaggio all'interno della scatola è realizzato in carta riciclata; controllare il contrassegno PAP sulla scatola.

Rimozione del calcare

- Rimuovere il calcare dalla macchina da caffè quando sul display viene visualizzato il relativo avviso di rimozione. Utilizzare solo aceto bianco per rimuovere il calcare, poiché altri prodotti potrebbero causare danni all'apparecchio.

Campi elettromagnetici (EMF)

Questo apparecchio Philips è conforme agli standard relativi ai campi elettromagnetici (EMF).

Riciclaggio



Questo simbolo indica che il prodotto non può essere smaltito con i normali rifiuti domestici (2012/19/UE).

Seguire le regole del proprio paese per la raccolta differenziata dei prodotti elettrici ed elettronici. Il corretto smaltimento aiuta a prevenire l'inquinamento ambientale e possibili danni alla salute delle persone.

Se non diversamente specificato, tutto il materiale di imballaggio all'interno della scatola è realizzato in carta riciclata; controllare il contrassegno PAP sulla scatola.

Garanzia e assistenza

Versuni offre una garanzia di due anni su questo prodotto dopo l'acquisto. La garanzia non è valida se il difetto è dovuto a un uso errato o a una scarsa manutenzione del prodotto. La nostra garanzia non influisce sui diritti dell'utente previsti dalla legge in quanto consumatore. Per ulteriori informazioni o per richiedere la garanzia, visitare il sito Web www.philips.com/support.

Prima di utilizzare l'apparecchio per la prima volta

Assicurarsi di pulire il portafiltro e il filtro permanente dopo ogni uso.

Pulire accuratamente il portafiltro con un panno asciutto dopo ogni uso. Assicurarsi di pulire ogni eventuale accumulo di condensa.

Impostazione dell'orologio

- 1 Collegare l'apparecchio alla presa di corrente.
 - Il display delle ore inizierà a lampeggiare.

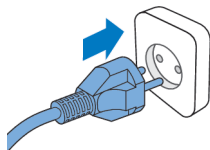

00:00



- 2 Utilizzare il pulsante freccia per regolare le ore.

08: (🔔)



- Una volta impostata l'ora, premere il pulsante del timer per confermare le ore.

08:06



- L'indicazione dei minuti inizierà a lampeggiare. Utilizzare il pulsante freccia per regolare i minuti.

08:06 (🔔)



- Premere il pulsante del timer per confermare i minuti.



08:06

- L'ora attuale è ora impostata e salvata.
- Per regolare il timer in modalità standby, è possibile scegliere tra i due approcci di seguito:
 - Scollegare l'apparecchio dalla presa e ricollegarlo.
 - Tenere premuto il pulsante del timer fino a che le cifre delle ore iniziano a lampeggiare.

Nota

L'apparecchio salva sempre l'ultima impostazione.

Durata del mantenimento della temperatura

È possibile scegliere per quanto tempo si desidera che il caffè rimanga caldo dopo l'erogazione regolando la durata quando l'apparecchio si spegne automaticamente. Il tempo di spegnimento automatico predefinito è 30 minuti. Il tempo massimo di spegnimento automatico è 300 minuti.

Per regolare il tempo di spegnimento automatico, seguire i passaggi riportati di seguito:

- Spegnere l'apparecchio e tenerlo collegato alla presa di corrente.
- Tenere premuto il pulsante di pulizia finché non viene visualizzata l'icona di mantenimento della temperatura e l'ora inizia a lampeggiare.
- Seguire il passaggio in "Impostazione dell'orologio" per completare l'impostazione.

Come lavare l'apparecchio

Lavare sempre la macchina da caffè una volta prima di utilizzarla per la prima volta seguendo i passaggi riportati di seguito.

Avviso: non versare mai acqua nel contenitore dei chicchi di caffè per evitare di danneggiare la macchina da caffè.

1 Aprire il coperchio del serbatoio dell'acqua.

Attenzione: non mettere i chicchi di caffè o il caffè pre-macinato nel serbatoio dell'acqua.

2 È possibile riempire il serbatoio dell'acqua in uno dei modi indicati di seguito:

- Sollevare il serbatoio dall'apparecchio e posizionarlo sotto l'acqua corrente per riempirlo.

- Assicurarsi che sia fissato correttamente al gancio quando viene riposizionato.
- Afferrare la linguetta del coperchio per sollevare il coperchio della caraffa. Posizionare la caraffa del caffè sotto l'acqua corrente per riempirla. Riempire il serbatoio dell'acqua usando la caraffa del caffè.
- Assicurarsi che l'acqua sia al di sotto del livello massimo.

3 Chiudere il coperchio del serbatoio dell'acqua.

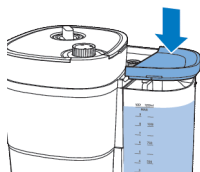
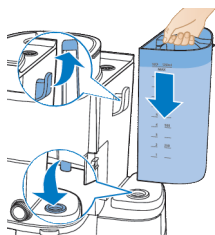
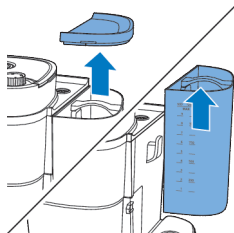

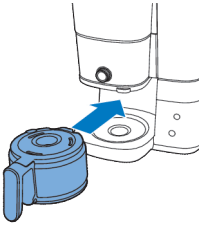

4 Posizionare la caraffa del caffè nell'apparecchio.

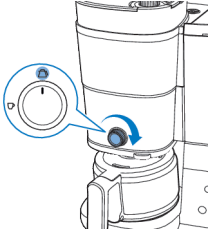

5 Ruotare la manopola centrale sull'impostazione caraffa.



6 Premere il pulsante on/off.
- L'apparecchio si accende.



7 Premere il pulsante dell'intensità del caffè e selezionare il caffè pre-macinato.

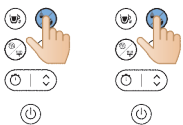

8 Premere il pulsante delle tazze e selezionare 10 tazze.

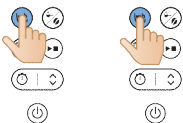



9 Premere il pulsante di avvio.

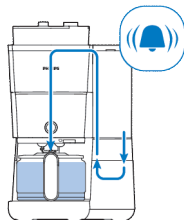

10 L'apparecchio avvia il processo di lavaggio.

11 Lasciare l'apparecchio in funzione fino al termine della procedura di lavaggio.

12 Svuotare la caraffa di vetro.

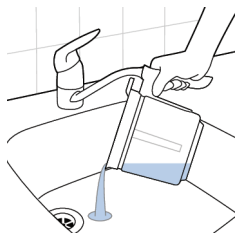

Utilizzo dell'apparecchio

Utilizzo dei chicchi di caffè

Nota: la macchina da caffè userà la quantità di acqua necessaria in base al numero di tazze da preparare

Per l'utilizzo, seguire i passaggi riportati di seguito:

1 Aprire il coperchio del serbatoio dell'acqua e sollevare il serbatoio dall'apparecchio.

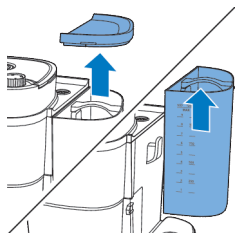



- 2 Riempire il serbatoio con l'acqua del rubinetto.
- Assicurarsi che l'acqua sia al di sotto del livello massimo.

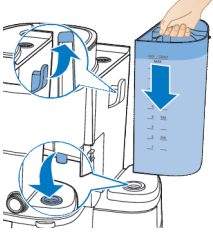

- 3 Riposizionare il serbatoio dell'acqua nell'apparecchio.
- Assicurarsi che sia fissato correttamente al gancio.

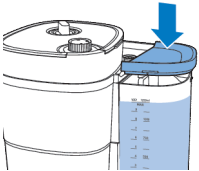

- 4 Chiudere il coperchio del serbatoio dell'acqua.

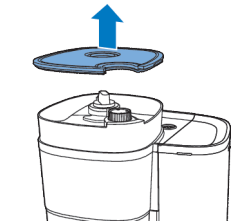

- 5 Sollevare il coperchio del contenitore dei chicchi di caffè.

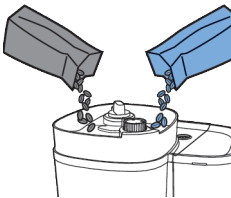

- 6 Aggiungere i chicchi di caffè desiderati nel contenitore.

Nota: assicurarsi sempre che il contenitore di chicchi di caffè freschi a due compartimenti sia pieno almeno a metà.

Avviso: per evitare inceppamenti del macinacaffè, non usare chicchi di caffè non tostati o caramellati. Utilizzare chicchi per il caffè normale invece di chicchi per espresso, in quanto questi ultimi potrebbero danneggiare il macinacaffè.

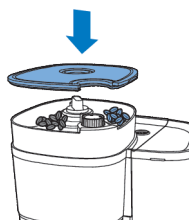

7 Chiudere il coperchio del contenitore dei chicchi di caffè.

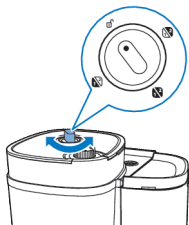

8 Ruotare la manopola di selezione del contenitore per scegliere i chicchi desiderati tra i due compartimenti del contenitore.
- È possibile anche unire due tipi diversi di chicchi per una miscela esclusiva.

Nota: quando si passa da un comparto a un altro del contenitore dei chicchi di caffè oppure a un altro tipo di caffè, rimangono sempre delle tracce dei chicchi di caffè precedentemente macinati. Per evitare questo inconveniente, pulire l'imboccatura del macinacaffè dopo essere passati a un altro tipo di caffè.

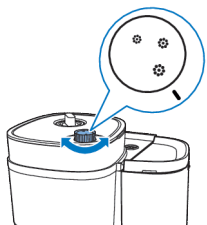

9 Scegliere il livello di macinatura desiderato utilizzando la manopola.

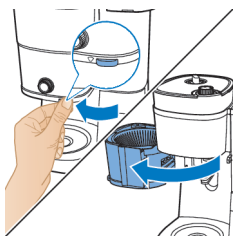

10 Afferrare la linguetta per aprire il portafiltro.

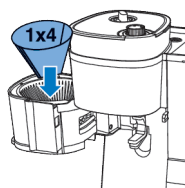

11 Posizionare un filtro di carta (tipo 1x4 o n. 4) nel cestello del filtro.

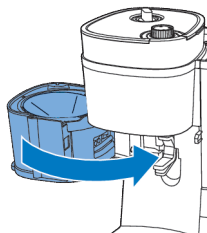

12 Chiudere il portafiltro.

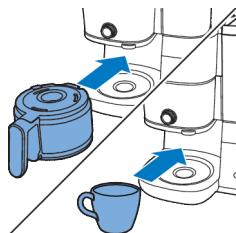

13 Posizionare la caraffa del caffè o la tazza sotto l'erogatore.

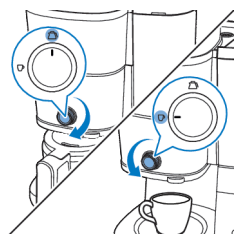

14 Utilizzare la manopola per selezionare la quantità di caffè che si desidera preparare.

Quando si utilizza la funzione di erogazione in tazza, è possibile utilizzare tazze in vetro o in ceramica, nonché bicchieri. Assicurarsi di utilizzare tazze con altezza inferiore a 10 cm.

10 3



15 Accendere l'apparecchio.

10 3



16 Selezionare il numero di tazze che si desidera preparare premendo il relativo pulsante.



17 Premere il pulsante dell'intensità del caffè per scegliere l'intensità preferita.

- 1: chicchi per caffè leggero
- 2: chicchi per caffè medio forte
- 3: chicchi per caffè forte



18 Avviare il processo premendo il pulsante di avvio/pausa.

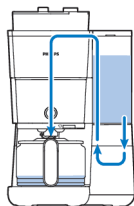

19 L'apparecchio avvia il processo.

- Al termine dell'erogazione, l'apparecchio emetterà un segnale acustico.

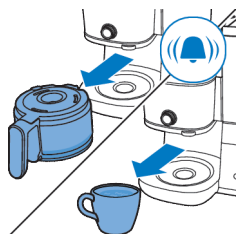

20 Rimuovere la tazza o la caraffa dall'apparecchio.

La funzione antigoccia consente di rimuovere la caraffa dalla macchina da caffè prima che il processo di erogazione sia terminato. Quando si rimuove la caraffa, il sistema antigoccia interrompe il flusso di caffè erogato nella caraffa.

il processo di erogazione non si interrompe quando viene rimossa la caraffa. Se la caraffa non viene riposizionata nell'apparecchio entro 20 secondi, il caffè fuoriesce dal cestello del filtro.



21 Il caffè appena fatto è pronto per essere gustato.

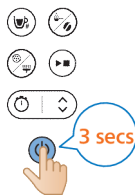

22 Per spegnere l'apparecchio, tenere premuto il pulsante di avvio/pausa per tre secondi.

23 Aprire il portafiltro.

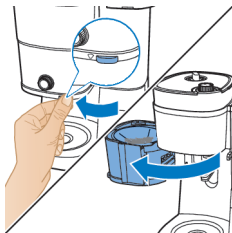

24 Rimuovere il filtro di carta usato.

La funzione di mantenimento della temperatura non si attiva quando si preparano una o due tazze.

L'apparecchio mantiene la bevanda calda fino a che non si spegne automaticamente. Se non si desidera più mantenere la bevanda calda, premere il pulsante on/off per spegnere l'apparecchio.

Utilizzo di caffè pre-macinato

Per l'utilizzo, seguire i passaggi riportati di seguito:

- 1** Verificare che nell'apparecchio vi sia acqua sufficiente per preparare la quantità di caffè desiderata.

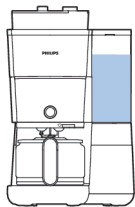

- 2** Afferrare la linguetta per aprire il portafiltro.

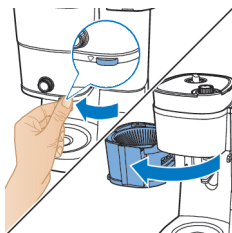

3 Posizionare un filtro di carta (tipo 1x4 o n. 4) nel cestello del filtro.

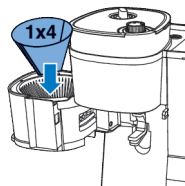

4 Aggiungere la quantità di caffè pre-macinato nel filtro di carta in uso in base alle preferenze personali.

- Per una tazza standard di caffè, usare 6 grammi di caffè macinato o 1 cucchiaino.

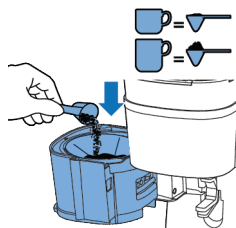

5 Chiudere il portafiltro.

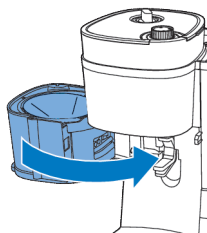

6 Posizionare la caraffa del caffè o la tazza sotto l'erogatore.

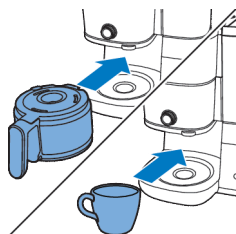

7 Utilizzare la manopola per selezionare la quantità di caffè che si desidera preparare.

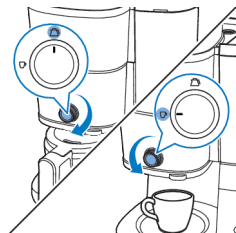



8 Accendere l'apparecchio.



9 Scegliere di utilizzare caffè pre-macinato premendo il pulsante di selezione modalità.

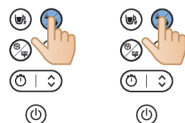

10 Selezionare il numero di tazze che si desidera preparare premendo il relativo pulsante.

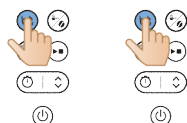

11 Avviare il processo premendo il pulsante di avvio/pausa.



12 L'apparecchio avvia il processo.

- Al termine dell'erogazione, l'apparecchio emetterà un segnale acustico.

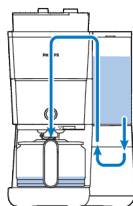

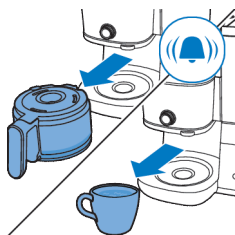

13 Rimuovere la tazza o la caraffa dall'apparecchio.



14 Il caffè appena fatto è pronto per essere gustato.

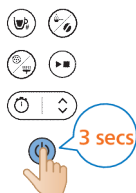

15 Per spegnere l'apparecchio, tenere premuto il pulsante di avvio/pausa per tre secondi.

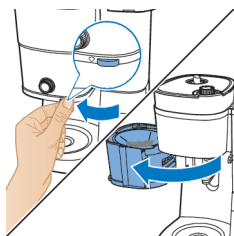

16 Aprire il portafiltro.

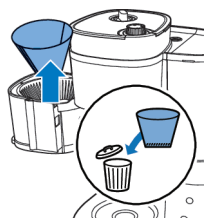

17 Rimuovere il filtro di carta usato.

Impostazione del timer

Per impostare il timer sull'apparecchio, seguire questi passaggi:

- 1 Accendere la macchina da caffè.
- 2 Premere il pulsante del timer e l'icona del timer apparirà sul display. Le cifre delle ore lampeggiano per indicare l'impostazione dell'ora.

08:06 



08:00



- 3 Utilizzare il pulsante freccia per regolare le ore. Se è necessaria una regolazione rapida, premere a lungo il pulsante freccia.

08: 



- 4 Premere il pulsante del timer per confermare l'impostazione dell'ora. Le cifre dei minuti indicano l'impostazione dei minuti.

08:06



- 5 Utilizzare nuovamente il pulsante freccia per regolare i minuti. Se è necessaria una regolazione rapida, premere a lungo il pulsante freccia.

08:05



- 6 Premere nuovamente il pulsante del timer per confermare l'impostazione dei minuti.

Per annullare il timer, è sufficiente premere il relativo pulsante; l'icona del timer scompare dal display.

La funzione antigoccia consente di rimuovere la caraffa dalla macchina da caffè prima che il processo di erogazione sia terminato. Quando si rimuove la caraffa, il sistema antigoccia interrompe il flusso di caffè erogato nella caraffa.

Nota: il processo di erogazione non si interrompe quando viene rimossa la caraffa. Se la caraffa non viene riposizionata nell'apparecchio entro 20 secondi, il caffè fuoriesce dal cestello del filtro.

Pulizia e manutenzione

Pulizia dopo ogni uso

Non immergere mai la macchina da caffè in acqua o in altri liquidi e non risciacquarla sotto l'acqua corrente.

- 1 Scollegare la spina dalla presa a muro.

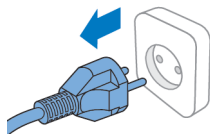









- 2 Pulire la parte esterna della macchina da caffè con un panno umido.
- 3 Lavare il cestello del filtro con acqua calda e del detersivo per piatti liquido oppure lavarlo in lavastoviglie.



- 4 Lavare la caraffa del caffè e il coperchio risciacquandoli sotto l'acqua corrente. Oppure lavarli in lavastoviglie.

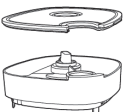

			
	✓	✓	✓
	✓	✓	✓
	✓	✓	✓
	✓	✗	✓
	✓	✗	✓

Pulizia dell'imboccatura del macinacaffè

Importante:

Pulire l'imboccatura del macinacaffè con una frequenza di 1-2 settimane per evitarne l'ostruzione con il caffè macinato. Per eseguire questa operazione in modo semplice e rapido, attenersi alla procedura riportata di seguito.

Pulire l'imboccatura del macinacaffè quando sul display compare un avviso relativo alla spazzolina.

Nota: assicurarsi che il contenitore dei chicchi di caffè sia vuoto prima di avviare la procedura di pulizia.

1 Collegare l'apparecchio alla presa di corrente.

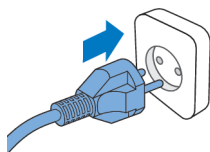

2 Aprire il portafiltro per accedere allo scivolo dell'imboccatura del caffè macinato.

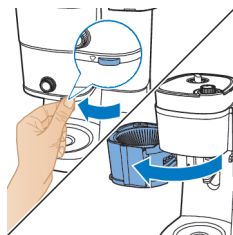

3 Accendere la macchina da caffè.

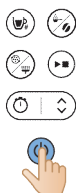

4 Premere il pulsante di pulizia sul pannello di controllo della macchina.

5 Selezionare l'impostazione della spazzolina sul display.



6 Premere il pulsante di avvio. In tal modo si aprirà lo sportellino dello scivolo dell'imboccatura del caffè macinato, consentendone la pulizia con una spazzolina.



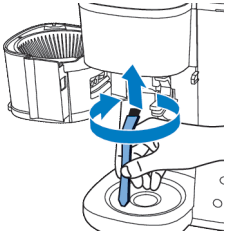

- 7 Utilizzare una spazzolina per rimuovere il caffè macinato o eventuali residui accumulati nello scivolo.



- 8 Dopo aver pulito lo scivolo, premere nuovamente il pulsante di avvio per chiudere lo sportellino.

Rimozione del calcare dalla macchina da caffè

Rimuovere il calcare dalla macchina da caffè quando sul display viene visualizzato il relativo avviso di rimozione. Utilizzare solo aceto bianco per rimuovere il calcare, poiché altri prodotti potrebbero causare danni alla macchina da caffè.

Avviso: non utilizzare mai aceto con un contenuto di acido acetico pari o superiore all'8%, aceto naturale, anticalcare in polvere o in pastiglie per rimuovere il calcare dalla macchina onde evitare di danneggiarla.

- 1 Aprire il coperchio del serbatoio dell'acqua.

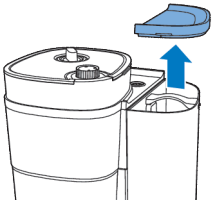

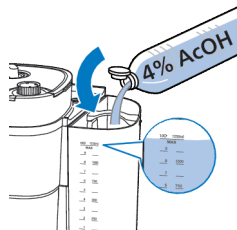

2 Riempire il serbatoio dell'acqua con aceto bianco (4% di acido acetico) fino all'indicazione di 10 tazze.

3 Chiudere il coperchio del serbatoio dell'acqua.

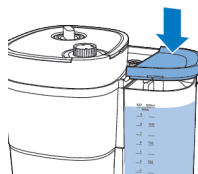

4 Afferrare la linguetta per aprire il portafiltro.

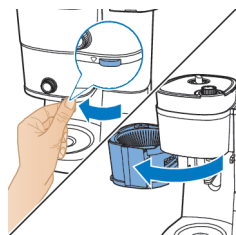

5 Posizionare un filtro di carta (tipo 1x4 o n. 4) nel cestello del filtro e chiudere il supporto del cestello.

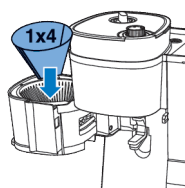

6 Posizionare la caraffa vuota nella macchina da caffè.

7 Inserire la spina nella presa a muro.

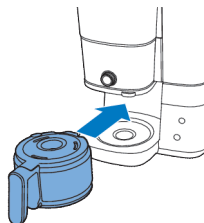

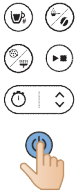

- 8** Premere il pulsante di accensione per accendere la macchina da caffè. Il display si accende.

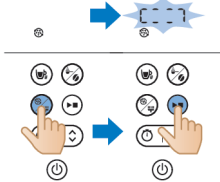

- 9** Premere il pulsante di pulizia sulla macchina da caffè.

10 Selezionare l'impostazione di rimozione del calcare.

11 Premere il pulsante di avvio per confermare la selezione.

- La macchina da caffè avvierà automaticamente il processo di rimozione del calcare.

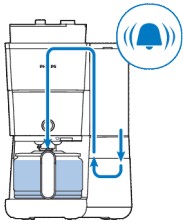

12 Attendere che la macchina termini l'erogazione della soluzione anticalcare.

13 Completato il processo di rimozione del calcare, risciacquare la macchina due volte con la quantità massima di acqua per rimuovere completamente eventuali depositi.

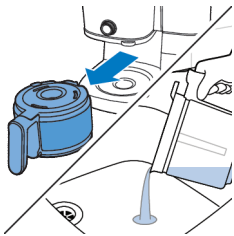

14 Svuotare la caraffa e rimuovere il filtro di carta con i residui di calcare.

15 Riempire il serbatoio dell'acqua con acqua fredda pulita e premere il pulsante di avvio per avviare un altro processo di erogazione.

Lasciare che la macchina da caffè completi l'intero processo di erogazione, quindi svuotare la caraffa.

Nota: se necessario, ripetere il passaggio 14 fino a quando l'acqua erogata dalla macchina non ha più il sapore o l'odore di aceto.

16 Pulire il cestello del filtro e la caraffa con acqua calda e un po' di detersivo per piatti liquido.

17 Premere il pulsante di accensione per spegnere l'apparecchio.

Risoluzione dei problemi

In questo capitolo vengono riportati i problemi più comuni legati all'uso della macchina. Se non è possibile risolvere il problema con le informazioni riportate di seguito, visitare il sito www.philips.com/support per un elenco di domande frequenti oppure contattare il centro assistenza clienti del proprio paese.



Per ottenere ulteriore assistenza online, è possibile anche eseguire la scansione di questo codice QR.

Problema

Soluzione

La macchina da caffè non funziona.

Inserire la spina nella presa a muro e premere il pulsante on/off per accendere la macchina da caffè.

Assicurarsi che la tensione indicata sulla macchina da caffè corrisponda a quella della rete locale.

Riempire con acqua il serbatoio dell'acqua.

Chiudere il coperchio dell'imboccatura del macinacaffè.

Il macinacaffè non funziona o non funziona correttamente.

Assicurarsi di non aver selezionato il caffè pre-macinato. Se sul display è visibile il simbolo del caffè pre-macinato, questo è stato selezionato.

Pulire l'imboccatura del macinacaffè seguendo le istruzioni.

Quando si utilizza il macinacaffè, il caffè è troppo leggero.

Ruotare la manopola di regolazione della macinatura per selezionare il tipo desiderato di macinatura, da fine a grossolana.

Utilizzare il pulsante di selezione dell'intensità per impostare l'intensità del caffè da 1 a 3; la cifra più alta indica un'intensità maggiore.

Utilizzare chicchi di caffè di una miscela o di un gusto più forte.

Quando si utilizza caffè pre-macinato, il caffè è troppo leggero.

Assicurarsi che la quantità di caffè pre-macinato nel filtro sia compatibile con la quantità di acqua presente nel serbatoio. Tenere presente che la macchina da caffè utilizza tutta l'acqua all'interno del serbatoio.

Utilizzare caffè macinato di una miscela o di un gusto più forte.

Per una maggiore intensità del caffè, aumentare la quantità di caffè pre-macinato oppure diminuire la quantità di acqua.

Il caffè fuoriesce dal filtro quando si rimuove la caraffa dalla macchina durante l'erogazione.

Se si rimuove la caraffa per più di 20 secondi durante il processo di erogazione, la funzione antigoccia causa la fuoriuscita del caffè dal cestello del filtro. Tenere inoltre presente che il caffè non raggiunge il suo gusto pieno prima della fine del processo di erogazione. Si consiglia pertanto di non rimuovere la caraffa e di non servire il caffè prima della fine del processo di erogazione.

Il caffè continua a sgocciolare dalla macchina da caffè anche molto dopo che il processo di erogazione è terminato.

Lo sgocciolamento è causato dalla condensa del vapore. È del tutto normale che la macchina da caffè continui a sgocciolare per un po' di tempo.

Non si riescono ad arrestare le ultime gocce.	Ruotare la manopola dalla modalità tazza alla modalità caraffa per attivare la funzione antigoccia, in modo da arrestare le gocce dal cestello del filtro.
	Se lo sgocciolamento non si interrompe, il sistema antigoccia potrebbe essere ostruito. Per pulire il sistema antigoccia, aprire il supporto del cestello del filtro ed estrarre il cestello. Risciacquare il cestello del filtro e il sistema antigoccia sotto l'acqua corrente.
Il caffè non è abbastanza caldo.	Il caffè nella caraffa si raffredda più velocemente se si preparano solo poche tazze. Il caffè rimane caldo più a lungo se si preparano 10 tazze, equivalenti alla caraffa piena.
	Rimuovere il calcare dalla macchina da caffè.
I chicchi di caffè sembrano esaurirsi rapidamente.	Per erogare una tazza di caffè perfetta, la macchina da caffè deve utilizzare una certa quantità di caffè macinato. La quantità di chicchi che la macchina da caffè utilizza per ottenere la quantità ottimale di caffè macinato per tazza è normale.
Il timer non funziona.	Assicurarsi di completare tutti i passaggi per l'erogazione del caffè con chicchi di caffè o caffè pre-macinato prima di impostare il timer.

Codice di errore

Codice di errore	Descrizione	Soluzione	Consiglio
E1	Carenza di acqua	Premere un pulsante qualsiasi per attivare la modalità standby. Riempire il serbatoio dell'acqua e riavviare l'apparecchio.	Se il problema persiste, attenersi alla seguente procedura: Tenere premuti il pulsante di pulizia e il pulsante di avvio contemporaneamente per tre secondi, finché l'apparecchio non inizia automaticamente a pompare acqua per un minuto. Ripetere questa procedura 3 volte. Se il problema persiste, contattare l'assistenza clienti.
E2	Contenitore dei chicchi di caffè non disponibile	Premere un pulsante qualsiasi per attivare la modalità standby. Fissare saldamente il contenitore dei chicchi di caffè e riavviare l'apparecchio	Se il problema persiste, contattare l'assistenza clienti.
E3	Malfunzionamento del tubo di riscaldamento	Scollare l'apparecchio dalla presa di corrente. Collegare e accendere di nuovo l'apparecchio quando si è raffreddato completamente.	Se il problema persiste, contattare l'assistenza clienti.

E4	Blocco della rotellina di macinatura	Scollegare l'apparecchio dalla presa di corrente. Collegare e accendere di nuovo l'apparecchio. Seguire i passaggi nella sezione "Pulizia dell'imboccatura del macinacaffè" per pulire la rotellina di macinatura e lo scivolo dell'imboccatura del caffè macinato.	Se il problema persiste, contattare l'assistenza clienti.
E5	Blocco dello scivolo dell'imboccatura del caffè macinato	Scollegare l'apparecchio dalla presa di corrente. Collegare e accendere di nuovo l'apparecchio. Seguire i passaggi nella sezione "Pulizia dell'imboccatura del macinacaffè" per pulire lo scivolo dell'imboccatura del caffè macinato.	Se il problema persiste, contattare l'assistenza clienti.
E6/E7/E8	Errore di programma	Scollegare l'apparecchio dalla presa di corrente. Collegare e accendere di nuovo l'apparecchio.	Se il problema persiste, contattare l'assistenza clienti.

Ievads

Apsveicam ar pirkumu un laipni lūdzam Philips!

Lai pilnībā gūtu labumu no Philips piedāvātā atbalsta, reģistrējiet savu izstrādājumu www.philips.com/welcome.

Vispārīgs apraksts

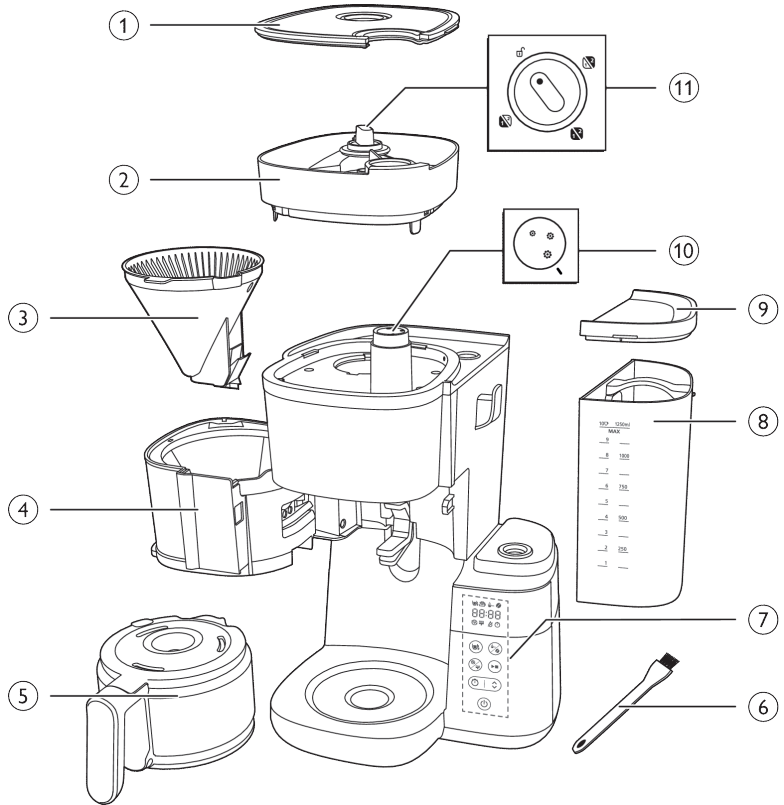

- 1 Pupīņu tvertnes vāks
- 2 Pupīņu tvertne
- 3 Filtra grozs
- 4 Filtra groza turētājs
- 5 Stikla krūze
- 6 Pupīņu teknes tīrīšanas suka
- 7 Vadības panelis ar displeju
- 8 Ūdens tvertne
- 9 Ūdens tvertnes vāks
- 10 Maluma regulators
- 11 Tvertnes selektora poga

Vadības panelis



Barošanas poga



Taimera poga un bultiņas poga laika regulēšanai



Poga Sākt/pauzēt



Tīrīšanas poga



Maltas kafijas un kafijas stipruma poga



Tases atlases poga

Displeja ikona



Tasišu skaits



Siltuma uzturēšanas režīms



Malta kafija



Kafijas stiprums



Atkaļķošana



Manuālas tīrīšanas brīdinājums



Maz ūdens



Taimeris



Laika displejs

Pirmie divi cipari apzīmē stundas, pēdējie divi cipari apzīmē minūtes.



Pagrieziet pogu atbloķētā pozīcijā, pēc tam varat noņemt pupiņu tvertni no ierīces.



Ar šo pogu var izvēlēties kafijas malumu, kur lielāks izmērs apzīmē raupjāku malumu.



Krūzes režīms

Krūzes režīmā ir pieejama pilēšanas apturēšanas funkcija.

Piezīme. Pagatavošanas process netiek pārtraukts, kad noņemat krūzi. Ja 20 sekunžu laikā krūzi neievietojat atpakaļ ierīcē, filtra grozs pārplūst.



Tasītes režīms

Manuāli pārslēdziet pogu no tasītes režīma uz krūzes režīmu, lai aktivizētu pilēšanas apturēšanas funkciju, kas novērš pilēšanu, kad uzliešanas cikls ir pabeigts.

Piezīme. Auksta keramikas krūze uzsilstot no kafijas absorbēs siltumu. Iepriekš uzsildiet tasīti karstā ūdenī.

Svarīgi

Brīdinājums!

- Pirms ierīces pievienošanas elektrotīklam pārbaudiet, vai uz tās norādītais spriegums atbilst elektrotīkla spriegumam jūsu mājā.
- Pievienojiet ierīci tikai iezemētai sienas kontaktligzdai.
- Neizmantojiet ierīci, ja ir bojāta tās kontaktdakša, elektrības vads vai pati ierīce.
- Ja elektrības vads ir bojāts, lai izvairītos no bīstamām situācijām, tas jānomaina Philips autorizētā servisa centrā vai pie līdzīgi kvalificētām personām.
- Šo ierīci var izmantot bērni vecumā no 8 gadiem un personas ar ierobežotām fiziskajām, sensorajām vai garīgajām spējām vai bez pieredzes un zināšanām, ja tiek nodrošināta uzraudzība vai norādījumi par drošu ierīces lietošanu un panākta izpratne par iespējamo bīstamību. Ierīces tīrīšanu un apkopi nedrīkst veikt bērni, ja vien tie nav vecāki par 8 gadiem un netiek uzraudzīti. Novietojiet ierīci un tās strāvas vadu vietā, kur tai nevar piekļūt par 8 gadiem jaunāki bērni.
- Bērni nedrīkst rotaļāties ar ierīci.
- Neļaujiet elektrības vadam karāties pāri galda vai darba virsmas malai, uz kuras stāv ierīce.
- Izmantojiet šo ierīci tikai paredzētajam mērķim, lai novērstu potenciāli bīstamības situācijas vai traumu gūšanu.

Uzmanību!

- Pirms pirmās lietošanas reizes vienmēr noskalojiet ierīci ar tīru ūdeni.
- Nenovietojiet ierīci uz karstas virsmas un neļaujiet elektrības vadam saskarties ar karstām virsmām.
- Nenovietojiet ierīci skapī, kamēr tā tiek lietota.
- Pirms ierīces tīrīšanas un gadījumos, ja rodas problēmas kafijas gatavošanas laikā, atvienojiet ierīci no elektrotīkla.
- Ierīci vienmēr tīriet, kad ierīce ir atdzisusi.
- Uzliešanas un siltuma uzturēšanas laikā, kā arī kādu laiku pēc tam ūdens tvertne, filtra turētājs, sildvirsmas, ierīces apakšējā daļa un krūze, kas piepildīta ar kafiju, ir karsti.
- Nelieciet krūzi uz plīts vai mikroviļņu krāsnī, lai uzsildītu kafiju.
- Šī ierīce ir paredzēta izmantošanai mājāsaimniecībā un līdzīgos apstākļos, piemēram: fermās, viesu mājās, darbinieku virtuvē veikalā, birojā vai citā darba vidē; klientu apkalpošanai viesnīcās, moteļos un citās dzīvojamās vidēs.
- Vienmēr nododiet ierīci Philips autorizētam servisa centram, ja nepieciešama apskate vai remonts. Neatveriet ierīci un nemēģiniet to pats salabot.
- Sildelementa virsmas, filtra turētājs, ierīces apakšējā daļa, sildvirsmas un krūze, kas piepildīta ar kafiju, kādu laiku pēc lietošanas var būt karsti.
- Ja nav norādīts citādi, visi kārbas iepakojuma materiāli ir izgatavoti no pārstrādāta papīra; skatiet PAP marķējumu uz kārbas.

Atkalķošana

- Atkalķojiet kafijas automātu, kad displejā tiek rādīts atkalķošanas brīdinājums. Atkalķošanas nolūkā izmantojiet tikai balto etiķi, jo citi produkti var radīt ierīces bojājumus.

Elektromagnētiskie lauki (EMF)

Šī Philips ierīce atbilst standartiem saistībā ar elektromagnētiskajiem laukiem (EMF).

Otrreizējā pārstrāde



Šis simbols nozīmē, ka izstrādājumu nedrīkst izmest kopā ar parastiem sadzīves atkritumiem (2012/19/ES).

Ievērojiet savā valstī spēkā esošos likumus par elektrisko un elektronisko produktu dalīto vākšanu. Pareiza likvidēšana palīdz novērst negatīvu ietekmi uz vidi un cilvēku veselību.

Ja nav norādīts citādi, visi kārbas iepakojuma materiāli ir izgatavoti no pārstrādāta papīra; skatiet PAP marķējumu uz kārbas.

Garantija un atbalsts

Versuni piedāvā divu gadu garantiju pēc produkta iegādes. Šī garantija nav derīga, ja defekts rodas nepareizas lietošanas vai pavisas apkopes dēļ. Mūsu garantija neietekmē tiesību aktos noteiktās patērētāja tiesības. Lai iegūtu papildinformāciju vai lai izmantotu garantiju, lūdzu, apmeklējiet mūsu tīmekļa vietni www.philips.com/support.

Pirms pirmās lietošanas reizes

Pēc katras lietošanas reizes iztīriet filtra turētāju un daudzkreiz lietojamo filtru.

Pēc katras lietošanas reizes rūpīgi noslaukiet filtra turētāju ar sausu drānu. Notīriet no tā visu uzkrājušos kondensātu.

Pulksteņa iestatīšana

- 1 Iespraudiet ierīces kontaktdakšu kontaktligzdā.
 - Sāks mirgot stundu displejs.

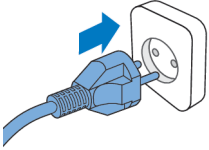

08:00



08:



- 2 Ar bultiņas pogu regulējiet stundu vērtību.



- 3 Kad stunda ir iestatīta, nospiediet taimera pogu, lai apstiprinātu stundu.

08:05



- 4 Sāks mirgot minūšu rādītājs. Nospiediet bultiņas pogu, lai regulētu minūtes.

08:06



08:06

5 Nospiediet taimera pogu, lai apstiprinātu minūtes.

- Pašreizējais laiks tagad ir iestatīts un saglabāts.
- 6 Taimera pielāgošanai gaidīšanas režīmā varat izvēlēties kādu no divām tālāk aprakstītajām metodēm.
 - Atvienojiet ierīci no elektrotīkla un pēc tam pievienojiet atkārtoti.
 - Turiet nospiestu taimera pogu, līdz sāk mirgot stundu cipari.

Piezīme

ierīce vienmēr saglabā pēdējo izmantoto iestatījumu.

Siltuma uzturēšanas laiks

Jūs varat izvēlēties, cik ilgi kafiju pēc pagatavošanas saglabāt karstu, pielāgojot laiku pēc tam, kad ierīce automātiski izslēdzas. Noklusējuma automātiskas izslēgšanas laiks ir 30 minūtes. Maksimālais automātiskas izslēgšanas laiks ir 300 minūtes.

Lai pielāgotu automātisko izslēgšanas laiku, veiciet tālāk norādītās darbības.

- 1 Izslēdziet ierīci un neatvienojiet to no elektrotīkla.
- 2 Turiet nospiestu tīrīšanas pogu, līdz tiek parādīta siltuma uzturēšanas ikona un stundu vērtība sāk mirgot.
- 3 Lai pabeigtu iestatīšanu, izpildiet sadaļā "Pulksteņa iestatīšana" aprakstītās darbības.

Ierīces skalošana

Pirms pirmās lietošanas reizes vienmēr izskalojiet kafijas automātu, veicot tālāk norādītās darbības.

Brīdinājums! Nekad nelejiet ūdeni pupiņu tvertnē, jo tas rada kafijas automāta bojājumus.

- 1 Noņemiet ūdens tvertnes vāku.

Uzmanību! Neievietojiet ūdens tvertnē kafijas pupiņas vai maltu kafiju.

- 2 Ūdeni var iepildīt ūdens tvertnē ar kādu no tālāk aprakstītajām metodēm.

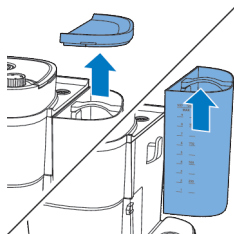



- Izceliet tvertni no ierīces un novietojiet to zem ūdens krāna, lai piepildītu ūdeni.

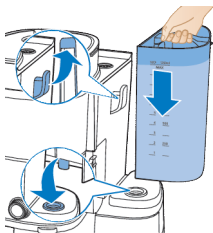

- Ievietojiet to atpakaļ, pārlicinieties, vai āķis ir pareizi piestiprināts.
- Satveriet vāka fiksatoru, lai paceltu krūzes vāku. Novietojiet kafijas krūzi zem ūdens krāna, lai piepildītu ūdeni. Piepildiet ūdens tvertni, izmantojot kafijas krūzi.
- Pārlicinieties, vai ūdens nepārsniedz maksimālo līmeni.

3 Uzlieciet ūdens tvertnes vāku.

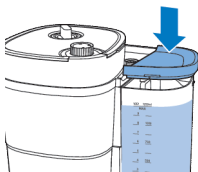

4 Ielieciet kafijas krūzi ierīcē.

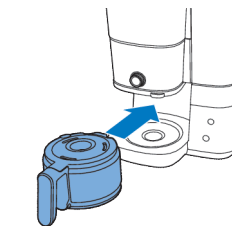

5 Pagrieziet centrālo pogu uz krūzes pozīciju.

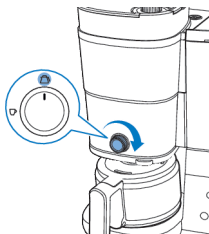



- 6** Piespiediet ieslēgšanas/izslēgšanas pogu.
- Ierīce ir ieslēgta.



- 7** Nospiediet kafijas stipruma pogu un izvēlieties maltu kafiju.

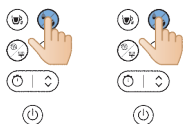

- 8** Nospiediet tasītes pogu un izvēlieties 10 tases.

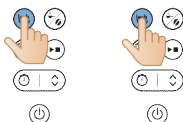

- 9** Nospiediet pogu Sākt.



- 10** Ierīce sāk skalošanas procesu.

- 11** Ļaujiet ierīcei darboties, līdz skalošanas process ir pabeigts.

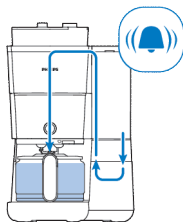



12 Iztukšojiet stikla krūzi.

Ierīces lietošana

Kafijas pupiņu izmantošana

Piezīme. Kafijas automāts izmantos nepieciešamo ūdens daudzumu, pamatojoties uz pagatavojamo kafijas tasišu daudzumu.

Veiciet tālāk norādītās darbības, lai to lietotu.

1 Noņemiet ūdens tvertnes vāku un izceliet tvertni no ierīces.

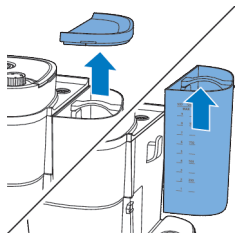

2 Piepildiet tvertni ar krāna ūdeni.

- Pārliecinieties, vai ūdens nepārsniedz maksimālo līmeni.



3 Ievietojiet tvertni atpakaļ ierīcē.

- Nodrošiniet, ka āķis ir pareizi nostiprināts.

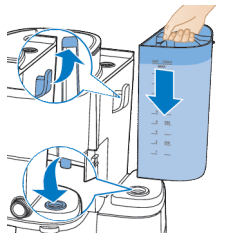

4 Uzlieciet ūdens tvertnes vāku.

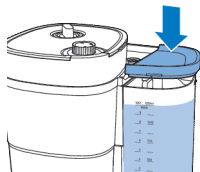

5 Noņemiet pupiņu tvertnes vāku.

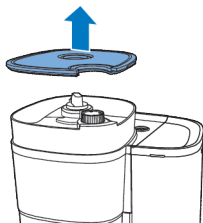

6 Ieberiet traukā vēlamās kafijas pupiņas.

Piezīme. Vienmēr pārliedzinieties, vai Duo kafijas pupiņu tvertne ir piepildīta vismaz līdz pusei.

Brīdinājums! Lai novērstu kafijas dzirnaviņu bojājumus, neberiet tajā negraudzētas vai karamelizētas kafijas pupiņas. Izmantojiet kafijas pupiņas, nevis espresso pupiņas, jo espresso pupiņas var sabojāt dzirnaviņas.

7 Uzlieciet pupiņu tvertnes vāku.

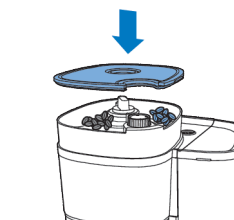

8 Pagrieziet tvertnes selektora pogu, lai izvēlētos tvertni ar vēlamajām pupiņām.

- Kā arī varat sajaukt divu dažādu veidu pupiņas, lai iegūtu unikālu maisījumu.

Piezīme. Mainot kafijas pupiņu tvertnes vai kafijas pupiņas, vienmēr būs novērojamas iepriekš malto kafijas pupiņu atliekas. Lai to novērstu, iztīriet dzirnaviņu piltuvi, kad nomaināt kafijas pupiņu veidu.

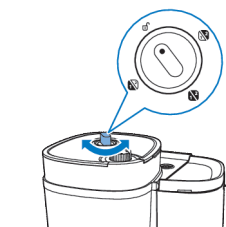

9 Izvēlieties vēlamo maluma līmeni, izmantojot pogu.

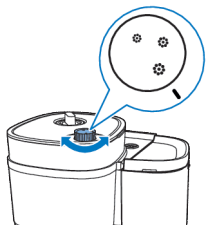

10 Satveriet izcilni, lai atvērtu filtra turētāju.

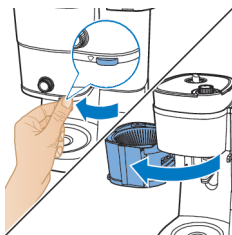

11 Ievietojiet papīra filtru (tips 1x4 vai Nr. 4) filtra grozā.

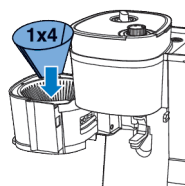

12 Aizveriet filtra turētāju.

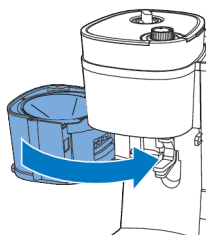

13 Novietojiet kafijas krūzi vai tasīti zem dozatora.

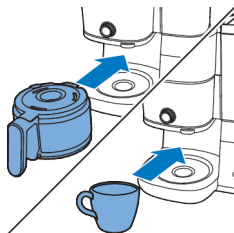

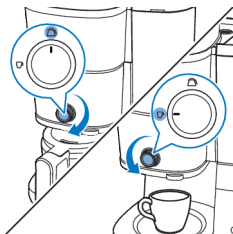

14 Izmantojiet pogu, lai izvēlētos vēlamo pagatavojamās kafijas daudzumu.

Izmantojot funkciju kafijas uzliesānai tasītē, varat izmantot gan stikla, gan keramikas krūzes, kā arī glāzes. Izmantojiet tasītes, kuras nav augstākas par 10 cm.

☕ 0
10 3

15 Ieslēdziet ierīci.



16 Atlasiet tasišu skaitu, ko vēlaties pagatavot, nospiežot tasišu pogu.

☕ 0
1 3



17 Nospiediet stipruma pogu, lai izvēlētos vēlamo kafijas stiprumu.

- 1: pupiņas maigai kafijai.
- 2: pupiņas vidēji stiprai kafijai.
- 3: pupiņas stiprai kafijai.

☕ 0
1 2



18 Sāciet procesu, nospiežot pogu Sākt/pauze.

☕ 0
1 1



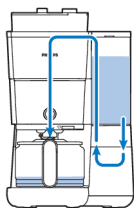

19 Ierīce sāk apstrādi.

- Ierīce atskaņos pīkstienus, kad gatavošana būs pabeigta.

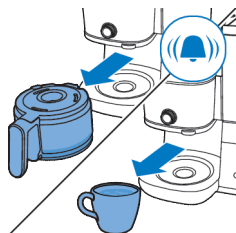

20 Izņemiet tasīti vai kafijas krūzi no ierīces.

Pilēšanas apturēšanas funkcija ļauj izņemt krūzi no kafijas automāta pirms uzliešanas procesa beigām. Kad izņemat krūzi, pilēšanas apturēšanas funkcija aptur kafijas plūsmu krūzē.

Pagatavošanas process netiek pārtraukts, kad noņemat krūzi. Ja 20 sekunžu laikā krūzi neievietojat atpakaļ ierīcē, filtra grozs pārplūst.



21 Izbaudiet svaigi pagatavoto kafiju.

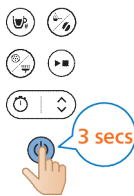

22 Lai izslēgtu ierīci, trīs sekundes turiet nospiestu pogu Sākt/pauzēt.

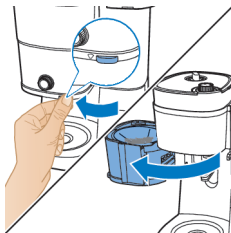

23 Atveriet filtra turētāju.

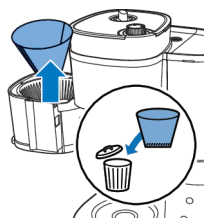

24 Izņemiet izlietoto papīra filtru.

Siltuma uzturēšanas funkcija netiek aktivizēta, kad tiek gatavota viena vai divas tasītes.

Ierīce dzērienu uzturēs karstu, līdz tā automātiski izslēgsies. Ja vēlaties, lai dzēriens vairs nesaglabātos karsts, nospiediet ieslēgšanas/izslēgšanas pogu, lai izslēgtu ierīci.

Maltās kafijas izmantošana

Veiciet tālāk norādītās darbības, lai to lietotu.

- 1 Pārbaudiet, vai ierīcē ir pietiekami daudz ūdens, lai pagatavotu vēlamo kafijas daudzumu.

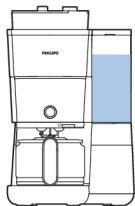

- 2 Satveriet izcilni, lai atvērtu filtra turētāju.

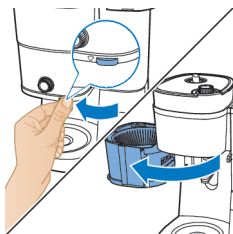

- 3 Ievietojiet papīra filtru (tips 1x4 vai Nr. 4) filtra grozā.

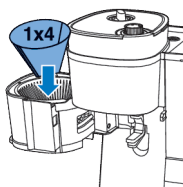

- 4 Ievietojiet malto kafiju papīra filtrā. Daudzums ir atkarīgs no personīgās gaumes.

- Standarta kafijas tasītei izmantojiet 6 gramus maltas kafijas vai 1 ēdamkaroti.

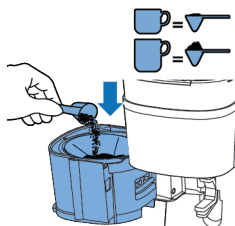

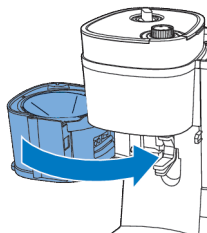

5 Aizveriet filtra turētāju.

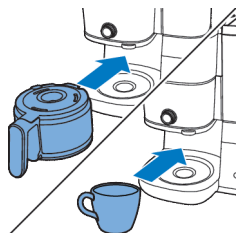

6 Novietojiet kafijas krūzi vai tasīti zem dozatora.

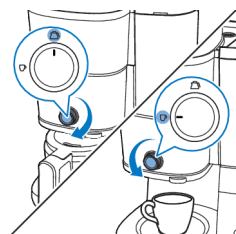

7 Izmantojiet pogu, lai izvēlētos vēlamo pagatavojamās kafijas daudzumu.

10 3

8 Ieslēdziet ierīci.



10 3 → 10 3

9 Izvēlieties izmantot maltu kafiju, nospiežot režīma izvēles pogu.





10 Atlasiet tasišu skaitu, ko vēlaties pagatavot, nospiežot tasišu pogu.

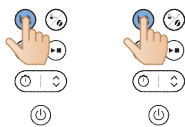

11 Sāciet procesu, nospiežot pogu Sākt/pauze.



12 Ierīce sāk apstrādi.

- Ierīce atskaņos pīkstienus, kad gatavošana būs pabeigta.

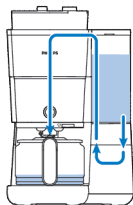

13 Izņemiet tasīti vai kafijas krūzi no ierīces.

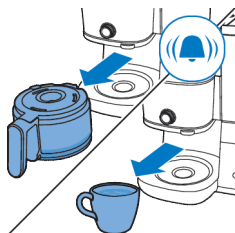

14 Izbaudiet svaigi pagatavoto kafiju.



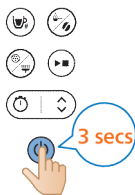

15 Lai izslēgtu ierīci, trīs sekundes turiet nospiestu pogu Sākt/pauzēt.

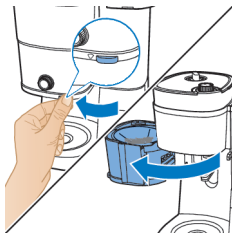

16 Atveriet filtra turētāju.

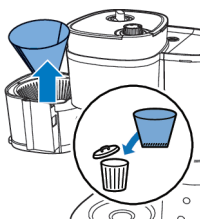

17 Izņemiet izlietoto papīra filtru.

Taimera iestatīšana

Lai iestatītu ierīces taimeri, veiciet tālāk norādītās darbības.

- 1 Ieslēdziet kafijas automātu.
- 2 Nospiediet taimera pogu – displejā tiks parādīta taimera ikona. Stundu cipari mirgo, norādot stundu vērtības iestatīšanu.

08:06



08:00



- 3 Izmantojiet bultiņas pogu, lai regulētu stundas. Ja regulēšanu nepieciešams veikt ātri, turiet bultiņas pogu nospiestu.

08:



- 4 Nospiediet taimera pogu, lai apstiprinātu stundu iestatījumu. Minūšu cipari norāda minūšu iestatīšanu.



08:05



- 5 Izmantojiet bultiņas pogu vēlreiz, lai regulētu minūtes. Ja regulēšanu nepieciešams veikt ātri, turiet bultiņas pogu nospiestu.

08:05



- 6 Nospiediet taimera pogu, lai apstiprinātu minūšu iestatījumu.

Lai atceltu taimeri, vienkārši nospiediet taimera pogu, taimera ikona pazudīs no displeja.

Pilēšanas apturēšanas funkcija ļauj izņemt krūzi no kafijas automāta pirms uzliešanas procesa beigām. Kad izņemat krūzi, pilēšanas apturēšanas funkcija aptur kafijas plūsmu krūzē.

Piezīme. Pagatavošanas process netiek pārtraukts, kad noņemat krūzi. Ja 20 sekunžu laikā krūzi neievietojat atpakaļ ierīcē, filtra grozs pārplūst.

Tīrīšana un apkope

Tīrīšana pēc katras lietošanas reizes

Nekad nelieciet kafijas automātu ūdenī vai kādā citā šķidrumā un neskalojiet to zem krāna.

1 Izvelciet elektrības kontaktdakšu no sienas kontaktligzdas.

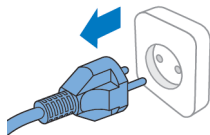









2 Noslaukiet kafijas automāta ārpusi ar mitru drānu.

3 Tīriet filtra grozu, izmantojot karstu ūdeni un nedaudz mazgājamā līdzekļa, vai mazgājiet to trauku mazgājamajā mašīnā.



4 Kafijas krūzi un vāku skalojiet krāna ūdenī. Vai arī tīriet tos trauku mazgājamajā mašīnā.

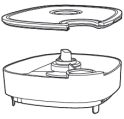

			
	✓	✓	✓
	✓	✓	✓
	✓	✓	✓
	✓	✗	✓
	✓	✗	✓

Dzirnaviņu piltuves tīrīšana

Svarīgi!

Tīriet dzirnaviņu piltuvi ik pēc 1–2 nedēļām, lai novērstu aizsērēšanu ar maltu kafiju. To var paveikt viegli un ātri, veicot tālāk norādītās darbības.

Tīriet dzirnaviņu piltuvi, kad displejā ievērojat sukas brīdinājumu.

Piezīme. Pirms tīrīšanas procedūras sākšanas pārlicinieties, ka kafijas pupiņu tvertne ir tukša.

1 Iespraudiet ierīces kontaktdakšu kontaktligzdā.

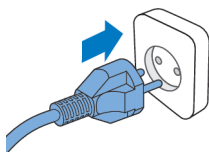

2 Atveriet filtra turētāju, lai piekļūtu maltās kafijas piltuves teknei.

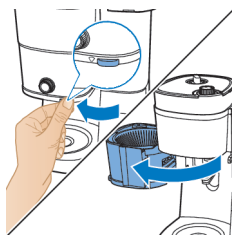

3 Ieslēdziet kafijas automātu.

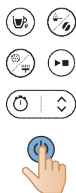

4 Kafijas automāta vadības panelī nospiediet tīrīšanas pogu.

5 Displeja ekrānā atlasiet sukas iestatījumu.





- 6 Nospiediet pogu Sākt. Tiks atvērts maltās kafijas piltuves teknes atloks, ļaujot tekni tīrīt ar suku.

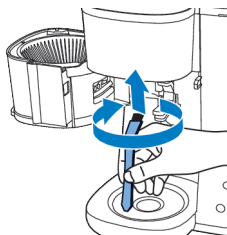

- 7 Izmantojiet suku, lai notīrītu malto kafiju vai atliekas, kas uzkrājušās tekne.



- 8 Pēc teknes tīrīšanas vēlreiz nospiediet pogu Sākt, lai aizvērtu atloku.

Kafijas automāta atkaļķošana

Atkaļķojiet kafijas automātu, kad displejā tiek rādīts atkaļķošanas brīdinājums. Atkaļķošanas nolūkā izmantojiet tikai balto etiķi, jo citi produkti var radīt kafijas automāta bojājumus.

Brīdinājums! Kafijas automāta atkaļķošanai nekādā gadījumā neizmantojiet etiķi, kura etiķskābes koncentrācija ir 8 % vai augstāka, dabīgo etiķi un pulverveida vai tablešu veida atkaļķotājus, jo tādējādi ierīci var sabojāt.

1 Noņemiet ūdens tvertnes vāku.

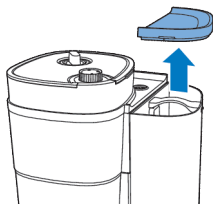

2 Iepildiet ūdens tvertnē balto etiķi (4 % etiķskābe) līdz 10 tasiņu atzīmei.

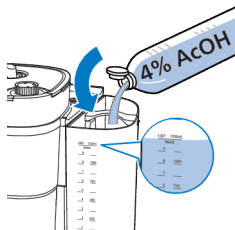

3 Uzlieciet ūdens tvertnes vāku.

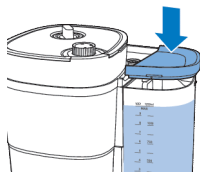

4 Satveriet izcilni, lai atvērtu filtra turētāju.

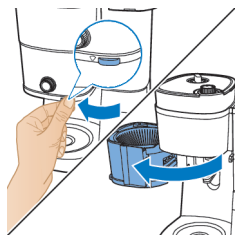

5 Ielieciet filtra grozā papīra filtru (tips 1x4 vai Nr. 4) un aizveriet filtra groza turētāju.

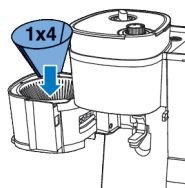

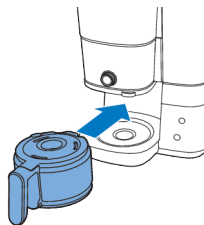

- 6 Ievietojiet tukšo krūzi kafijas automātā.
- 7 Ievietojiet kontaktdakšu sienas kontaktligzdā.

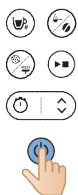

- 8 Lai ieslēgtu kafijas automātu, piespiediet ieslēgšanas/izslēgšanas pogu. Iedegas displejs.

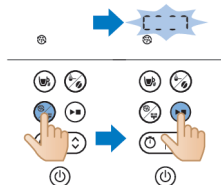

- 9 Nospiediet kafijas automāta tīrīšanas pogu.
- 10 Izvēlieties atkaļķošanas iestatījumu.
- 11 Nospiediet pogu Sākt, lai apstiprinātu atlasīto.
 - Kafijas automāts automātiski sāks atkaļķošanas procesu.

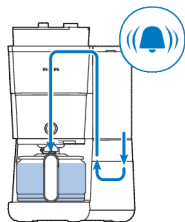

- 12 Uzgaidiet, līdz kafijas automāts ir pabeidzis atkaļķošanas šķīduma uzliešanu.
- 13 Kad atkaļķošanas process ir pabeigts, divreiz izskalojiet kafijas automātu ar maksimālo ūdens daudzumu, lai pilnībā likvidētu visus nosēdumus.

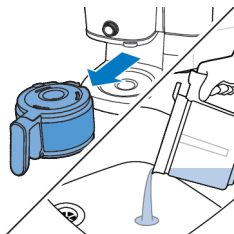

- 14 Iztukšojiet krūzi un izņemiet papīra filtru ar kaļķakmens nogulsniem.
- 15 Piepildiet ūdens tvertni ar svaigu aukstu ūdeni un nospiediet pogu Sākt, lai sāktu jaunu gatavošanas procesu.

Ļaujiet kafijas automātam pabeigt visu gatavošanas procesu un iztukšojiet krūzi.

Piezīme. Ja nepieciešams, atkārtojiet 14. darbību, līdz ūdens, kas izplūst no kafijas automāta, negaršo un nesmaržo pēc etiķa.

- 16 Tīriet filtra grozu un krūzi karstā ūdenī, kam pievienots mazgāšanas līdzeklis.
- 17 Lai izslēgtu ierīci, piespiediet ieslēgšanas/izslēgšanas pogu.

Problēmu novēršana

Šajā nodaļā apkopota informācija par izplatītākajām problēmām, kas var rasties iekārtai. Ja nevarat novērst problēmu, izmantojot tālāk sniegto informāciju, apmeklējiet vietni www.philips.com/support, lai skatītu bieži uzdoto jautājumu sarakstu, vai arī sazinieties ar klientu apkalpošanas centru savā valstī. Kā arī varat skenēt šo kvadrātkodu, lai iegūtu papildu atbalstu tiešsaistē.



Problēma	Risinājums
Kafijas automāts nedarbojas.	Iespraudiet kontaktdakšu kontaktligzdā un nospiediet ieslēgšanas/izslēgšanas pogu, lai ieslēgtu kafijas automātu.
	Pārliedzinieties, vai uz kafijas automāta norādītais spriegums atbilst vietējam elektrotīkla spriegumam.
	Piepildiet ūdens tvertni ar ūdeni.
	Uzlieciet dzirnaviņu piltuves vāku.
Dzirnaviņas nedarbojas vai nedarbojas pareizi.	Pārliedzinieties, vai neizvēlējāties maltu kafiju. Ja displejā ir redzams maltas kafijas simbols, jūs izvēlējāties maltu kafiju.
	Iztīriet dzirnaviņu piltuvi, izpildot norādījumus.
Izmantojot dzirnaviņas, kafija ir pārāk vāja.	Pagrieziet maluma regulatoru, lai izvēlētos vēlamo maluma veidu no smalka līdz rupjam.
	Izmantojiet kafijas stipruma atlasēsi pogu, lai iestatītu kafijas stiprumu no 1 līdz 3, lielāks cipars nozīmē lielāku stiprumu.
	Izmantojiet kafijas pupiņas ar stiprāku maisījumu vai garšu.
Izmantojot maltu kafiju, kafija ir pārāk vāja.	Pārliedzinieties, vai maltās kafijas daudzums filtrā atbilst ūdens daudzumam ūdens tvertnē. Ņemiet vērā, ka kafijas automāts izmanto visu ūdens tvertnē esošo ūdeni.
	Izmantojiet malto kafiju ar stiprāku maisījumu vai garšu.
	Lai kafija būtu stiprāka, palieliniet maltās kafijas daudzumu vai arī samaziniet ūdens daudzumu.
Filtrs pārplūst, kad kafijas pagatavošanas laikā krūze tiek izņemta no kafijas automāta.	Ja kafijas gatavošanas procesa laikā krūze ir izņemta ilgāk par 20 sekundēm, pilēšanas apturēšanas elements izraisa filtra groza pārplūšanu. Ņemiet vērā arī to, ka kafija nenasniedz pilnīgu garšu līdz pagatavošanas procesa beigām. Tādēļ mēs iesakām neizņemt krūzi un neliet kafiju pirms gatavošanas procesa beigām.

Kafijas automāts turpina pilēt vēl ilgi pēc pagatavošanas procesa beigām.	Pilēšanu izraisa tvaika kondensācija. Tas, ka kafijas automāts kādu laiku izvada pilienus, ir pilnīgi normāli.
Nevarat sagaidīt dažus pēdējos pilienus.	Pārslēdziet pogu no tasītes režīma uz krūzes režīmu, lai aktivizētu pilēšanas apturēšanas funkciju, pilēšanas aktivizēšanas elements apturēs pilēšanu no filtra groza.
Kafija nav pietiekami karsta.	Ja pilēšana netiek pārtraukta, iespējams, pilēšanas apturēšanas elements ir aizsērējis. Lai iztīrītu pilēšanas apturēšanas elementu, atveriet filtra groza turētāju un izņemiet filtra grozu. Krāna ūdeni izskalojiet filtra grozu un pilēšanas apturēšanas elementu.
Kafijas pupiņas, šķiet, beidzas pārāk ātri.	Atkalņojiet kafijas automātu.
Kafijas pupiņas, šķiet, beidzas pārāk ātri.	Lai pagatavotu perfektas kafijas tasīti, kafijas automātam ir nepieciešams noteikts daudzums maltas kafijas. Kafijas pupiņu daudzums, ko kafijas automāts izmanto, lai iegūtu optimālu maltās kafijas daudzumu uz vienu tasīti, ir normāls.
Taimeris nedarbojas.	Pirms taimera iestatišanas pārlicinieties, vai izpildījāt visas darbības kafijas pagatavošanai ar kafijas pupiņām vai maltu kafiju.

Kļūdas kods

Kļūdas kods	Apraksts	Risinājums	Piezīmes
E1	Nepietiekami daudz ūdens	Nospiediet jebkuru pogu, lai pārslēgtu ierīci gaidīšanas režīmā. Uzpildiet ūdens tvertni un restartējiet ierīci.	Ja problēma nepazūd, veiciet tālāk norādītās darbības. Trīs sekundes vienlaikus turiet nospiestu tīrīšanas pogu un pogu Sākt, līdz ierīce automātiski sāk vienu minūti sūknēt ūdeni. Atkārtojiet šo procesu 3 reizes. Sazinieties ar klientu apkalpošanas dienestu, ja problēma nepazūd.
E2	Pupiņu tvertne nav pieejama	Nospiediet jebkuru pogu, lai pārslēgtu ierīci gaidīšanas režīmā. Stingri piestipriniet pupiņu tvertni un restartējiet ierīci.	Sazinieties ar klientu apkalpošanas dienestu, ja problēma nepazūd.
E3	Sildīšanas caurules darbības traucējumi	Atvienojiet ierīci no elektrotīkla. Pievienojiet ierīci elektrotīklam un ieslēdziet to, kad tā ir pilnībā atdzisusi.	Sazinieties ar klientu apkalpošanas dienestu, ja problēma nepazūd.

E4	Dzirnaviņu rats ir bloķēts	Atvienojiet ierīci no elektrotīkla. Pievienojiet ierīci elektrotīklam un ieslēdziet to. Izpildiet sadaļā "Dzirnaviņu piltuves tīrīšana" sniegtās norādes, lai iztīrītu dzirnaviņu ratu un maltās kafijas piltuves tekni.	Sazinieties ar klientu apkalpošanas dienestu, ja problēma nepazūd.
E5	Maltās kafijas piltuves tekne ir bloķēta	Atvienojiet ierīci no elektrotīkla. Pievienojiet ierīci elektrotīklam un ieslēdziet to. Izpildiet sadaļā "Dzirnaviņu piltuves tīrīšana" sniegtās norādes, lai iztīrītu maltās kafijas piltuves tekni.	Sazinieties ar klientu apkalpošanas dienestu, ja problēma nepazūd.
E6/E7/E8	Programmas kļūda	Atvienojiet ierīci no elektrotīkla. Pievienojiet ierīci elektrotīklam un ieslēdziet to.	Sazinieties ar klientu apkalpošanas dienestu, ja problēma nepazūd.

Bevezetés

A Philips köszönti Önt! Gratulálunk a vásárláshoz!

A Philips által biztosított teljes körű támogatáshoz regisztrálja termékét a www.philips.com/welcome oldalon.

Általános leírás

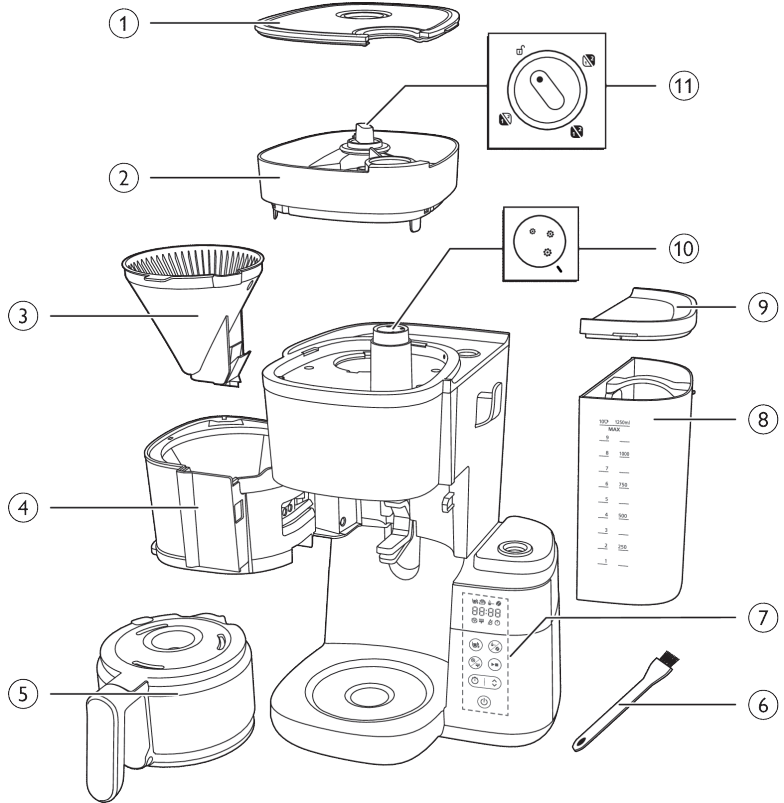

- 1 Szemeskávé-tartály fedele
- 2 Szemeskávé-tartály
- 3 Szűrőkosár
- 4 Szűrőkosár tartója
- 5 Üvegkanna
- 6 Szemeskávé-leeresztő tisztítókefeje
- 7 Kezelőpanel kijelzővel
- 8 Vízartály
- 9 A vízartály fedele
- 10 Őrlésbeállító gomb
- 11 Tartályválasztó gomb

Kezelőpanel



Bekapcsoló gomb



Időzítő gomb és időbeállító nyíl gomb



Indítás/szüneteltetés gomb



Tisztítás gomb



Előőrölt kávé és kávéerősség gomb



Csészeválasztó gomb

Kijelző ikon



Csészék száma



Melegen tartó mód



Előőrölt kávé



Kávéerősség



Vízkömentesítés



Szűrőtisztításra vonatkozó riasztás



Alacsony vízszint



Időzítő



Idő kijelzője

Az első két számjegy az órákat, az utolsó két számjegy pedig a perceket jelzi.



Fordítsa a gombot nyitott állásba, ekkor el tudja távolítani a szemeskávét a készülékről.



Ezzel a gombbal választhatja ki az órles finomságát; a nagyobb méret durvább órlest jelez.



Kanna üzemmód

A cseppzáró funkció kanna üzemmódban működik.

Megjegyzés: A kanna eltávolításakor a főzés nem áll le. Ha 20 másodpercen belül nem helyezi vissza a kannát a készülékbe, a szűrőkosár túlsordul.



Csésze üzemmód

Annak érdekében, hogy a főzési ciklus befejeződése után megakadályozza a csepegést, nyissa ki a cseppzárót. Ehhez manuálisan állítsa át a gombot csésze üzemmódból kanna üzemmódba.

Megjegyzés: Felmelegedés közben a hideg kerámia bögre hőt von el a kávétól, ezért forró vízzel melegítse elő a bögrét.

Fontos

Figyelmeztetés

- A készülék csatlakoztatása előtt ellenőrizze, hogy a rajta feltüntetett feszültség egyezik-e a helyi hálózatával.
- Csatlakoztassa a készüléket földelt fali konnektorhoz.
- Ne használja a készüléket, ha a hálózati csatlakozódugó, a kábel vagy a készülék sérült.
- Ha a hálózati kábel meghibásodott, a kockázatok elkerülése érdekében Philips szakszervizben vagy hivatalos szakszervizben ki kell cserélni.
- A készüléket 8 éven felüli gyermekek, illetve csökkent fizikai, érzékelési vagy szellemi képességekkel rendelkező, vagy a készülék működtetésében járatlan személyek is használhatják, amennyiben ezt felügyelet mellett teszik, illetve ismerik a készülék biztonságos működtetésének módját és az azzal járó veszélyeket. A tisztítást és a felhasználó által is végezhető karbantartást soha ne végezze 8 éven aluli gyermek, és 8 éven felüli gyermek is csak felügyelet mellett végezheti el ezeket. A készüléket és a vezetékét tartsa távol 8 éven aluli gyermekektől.
- Ne engedje, hogy gyermekek játsszanak a készülékkel.
- Ügyeljen arra, hogy a hálózati kábel ne lógjon le az asztalról vagy a munkalapról, amelyiken a készülék áll.
- A lehetséges veszélyek és sérülések elkerülése érdekében a készüléket kizárólag rendeltetésszerű célra használja.

Vigyázat!

- Az első használat előtt friss vízzel mindig öblítse át a készüléket.
- Soha ne helyezze a kávéfőzőt forró felületre, és ügyeljen arra, hogy a hálózati kábel se érintkezzen forró felülettel.
- Használat közben soha ne tegye a készüléket a szekrénybe.
- Húzza ki a készülék hálózati csatlakozó dugóját a fali aljzatból tisztítás előtt, vagy ha kávéfőzés közben problémák adódnának.
- Mindig tisztítsa meg a készüléket, miután lehűlt.
- Kávéfőzés és melegen tartás közben a víztartály, a szűrőtartó, a melegen tartó lap, a készülék alsó része és a kávéval teli kanna még valamennyi idő elteltével is forró.
- A kávé újramelegítéséhez ne tegye a kannát tűzhelyre vagy mikrohullámú sütőbe.
- Ez a készülék háztartási vagy hasonló felhasználási helyszínekre ajánlott, mint például: üzletek, irodák és más, munkahelyen található személyzeti konyhák; nyaralók; hotelek, motelek és más hasonló típusú környezetek; „szoba reggelivel” típusú vendéglátói környezetek.
- A készüléket kizárólag Philips hivatalos szakszervizbe vigye vizsgálatra, illetve javításra. Ne nyissa fel, és ne próbálja meg önállóan megjavítani a készüléket.
- A melegítőegység felülete, a szűrőtartó, a készülék alsó része, a melegen tartó lap és a kávéval teli kanna még használat után is meleg marad egy ideig.
- Amennyiben nincs másként feltüntetve, a dobozban lévő valamennyi csomagolóanyag újrahasznosított papírból készült; lásd a dobozon található PAP jelölést.

Vízkömentesítés

- Vízkömentesítse a kávéfőzőt, amikor a kijelzőn megjelenik a vízkömentesítésre figyelmeztető riasztás. A vízkömentesítéshez kizárólag fehér ecetet használjon, mivel más termékek károsíthatják a készüléket.

Elektromágneses mezők (EMF)

Ez a Philips készülék megfelel az elektromágneses mezőkre (EMF) vonatkozó szabványoknak.

Újrahasznosítás



Ez a szimbólum azt jelenti, hogy a termék nem kezelhető normál háztartási hulladékként (2012/19/EU).

Kövesse az országában érvényes, az elektromos és elektronikus készülékek hulladékkezelésére vonatkozó jogszabályokat. A megfelelő hulladékkezelés segítséget nyújt a környezettel és az emberi egészséggel kapcsolatos negatív következmények megelőzésében.

Amennyiben nincs másként feltüntetve, a dobozban lévő valamennyi csomagolóanyag újrahasznosított papírból készült; lásd a dobozon található PAP jelölést.

Garancia és támogatás

A Versuni két éves garanciát nyújt a termék megvásárlását követően. Ez a garancia nem érvényes, ha a hiba helytelen használat vagy nem megfelelő karbantartás miatt következett be. A garanciánk nem érinti a törvény által biztosított fogyasztói jogokat. További információért vagy a garancia igénybe vételéhez látogasson el weboldalunkra: www.philips.com/support.

Teendők az első használat előtt

A szűrőtartót és az állandó szűrőt minden használat után tisztítsa meg.

Egy száraz kendővel minden használat után alaposan törölje át a szűrőtartót. Minden felhalmozódott maradványt távolítson el.

Az óra beállítása

- 1 Csatlakoztassa a készülék hálózati dugóját a fali aljzatba.
 - Az óra kijelzője villogni kezd.

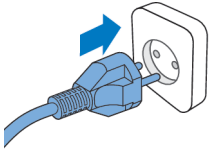

08:00



- 2 Állítsa be az órát a nyíl gombokkal.

08:



- 3 Az óra beállítása után nyomja meg az időzítő gombot az óra jóváhagyásához.

08:06



08:06



08:06

4 A percek kijelzője villogni kezd. Állítsa be a percet a nyílombokkal.

5 Nyomja meg az időzítő gombot a perc jóváhagyásához.

- Az aktuális idő beállítása és mentése megtörtént.
- 6 Ha készenléti üzemmódban szeretné módosítani az időzítőt, az alábbi két megoldás közül választhat:
 - Húzza ki a készüléket a hálózati aljzatból, majd csatlakoztassa ismét.
 - Nyomja meg, és tartsa nyomva az időzítő gombot, amíg az óra számjegy villogni nem kezd.

Megjegyzés

A készülék mindig elmenti az utolsó beállítást.

Melegen tartási idő

Meghatározhatja, hogy az elkészült kávé milyen hosszú ideig maradjon forró. Ehhez állítsa be azt az időt, ami után a készülék automatikusan kikapcsol. A készülék alapértelmezés szerint 30 perc elteltével kapcsol ki automatikusan. A leghosszabb beállítható automatikus kikapcsolási idő 300 perc.

Az automatikus kikapcsolási idő módosításához kövesse az alábbi lépéseket:

- 1 Kapcsolja ki, és tartsa a hálózathoz csatlakoztatva a készüléket.
- 2 Nyomja meg, és tartsa nyomva a tisztítás gombot, amíg meg nem jelenik a melegen tartás ikon, és az óra villogni nem kezd.
- 3 A beállítás befejezéséhez kövesse „Az óra beállítása” részben leírt lépéseket.

A készülék átöblítése

Az első használat előtt mindig öblítse át a kávéfőzőt az alábbi lépéseket követve.

Figyelmeztetés: Soha ne öntsön vizet a szemeskávé-tartályba, mert ez károsíthatja a kávéfőzőt.

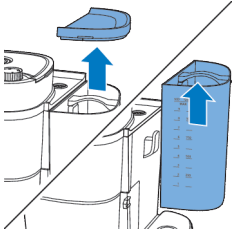

1 Nyissa ki a víztartály fedelét.

Figyelem! Ne tegyen szemeskávét vagy előőrölt kávé a víztartályba.

2 Az alábbi módszerek valamelyikével tölthet vizet a víztartályba:

- Emelje le a tartályt a készülékről, tartsa a vízcsap alá, és töltsse meg vízzel.



- Visszahelyezéskor ügyeljen rá, hogy a horog megfelelően a helyére kerüljön.

- Fogja meg a kanna fülét, és nyissa fel a kanna fedelét. Helyezze a kannát a vízcsap alá, és töltsse meg vízzel. Töltsse meg a víztartályt a kávékannából.

- Ügyeljen rá, hogy a vízmennyiség a maximális szint alatt legyen.

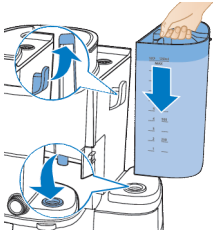

3 Zárja le a víztartály fedelét.

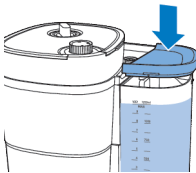

4 Helyezze a kávékannát a készülékbe.

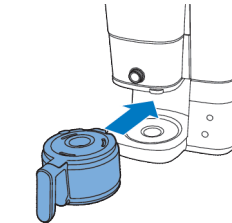

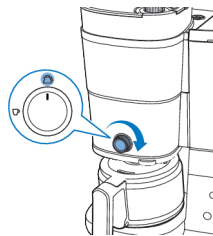

5 Forgassa a központi gombot a kanna állásra.

☕ ☕
10 3

6 Nyomja meg a be-/kikapcsoló gombot.

- A készülék be van kapcsolva.



7 Nyomja meg a kávéerősség gombot, és válassza ki az előőrölt kávé lehetőséget.



8 Nyomja meg a csésze gombot, és válassza a 10 csésze lehetőséget.



9 Nyomja meg az indítás gombot.



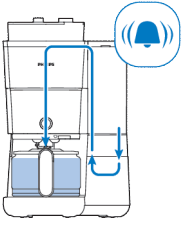

10 A készülék megkezdi az átöblítést.

11 Hagyja működni a készüléket, amíg az átöblítés be nem fejeződik.



12 Ürítse ki az üveggannát.

A készülék használata

Szemeskávé használata

Megjegyzés: a kávéfőző annyi vizet fog felhasználni, amennyi csésze kávéét kell készítenie.

A használathoz kövesse az alábbi lépéseket:

1 Nyissa fel a víztartály tetejét, és emelje le a tartályt a készülékről.

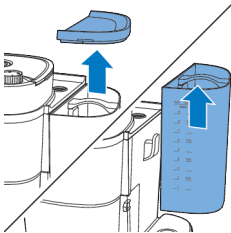

2 Töltse meg a tartályt csapvízzel.

- Ügyeljen rá, hogy a vízmennyiség a maximális szint alatt legyen.

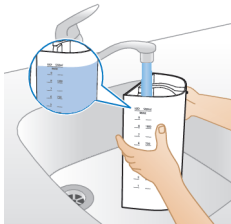

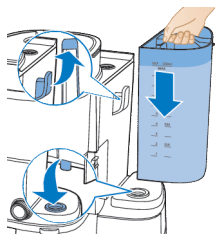

- 3 Helyezze vissza a tartályt a készülékre.
- Ügyeljen a horog megfelelő illesztésére.

- 4 Zárja le a víztartály fedelét.

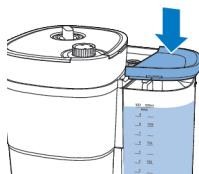

- 5 Emelje fel a szemeskávé-tartály fedelét.

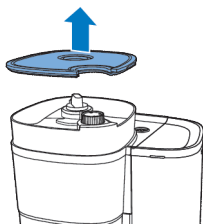

- 6 Öntse a kívánt mennyiségű szemeskávét a tartályba.

Megjegyzés: Ügyeljen arra, hogy a friss kávébab tartálya/a Duo Bean tartály mindig legalább félig tele legyen.

Figyelmeztetés: Az őrlőbetét eltömődésének megakadályozása érdekében ne használjon pörköletlen vagy karamellizált szemeskávét. Eszpresszóhoz való kávébab helyett használjon egyszerű kávébabot, mert az eszpresszó-kávébab károsíthatja az őrlőbetétet.

- 7 Zárja le a szemeskávé-tartály fedelét.

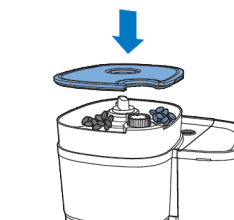

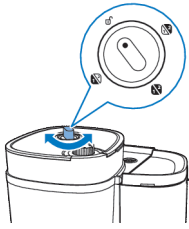

- 8** A tartályválasztó gomb elforgatásával válassza ki a két szemeskávétartály közül a megfelelőt.
- Az egyedi keverék eléréséhez akár két különböző fajtájú szemeskávét is használhat.

Megjegyzés: Amikor átvált az egyik szemeskávétartályról vagy szemeskávéről egy másikra, minden esetben visszamarad valamennyi az előzőleg megőrölt szemeskávét-fajtából. Ennek megakadályozása érdekében tisztítsa meg az őrlőtölcsért, amikor újfajta szemeskávéra vált.

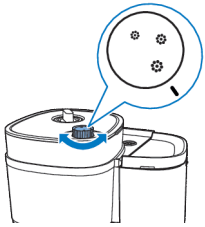

- 9** A gomb elforgatásával válassza ki a kívánt durvaságú őrleést.

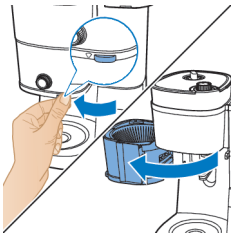

- 10** Fogja meg a fület, és nyissa ki a szűrőtartót.

- 11** Tegyen (1x4 típusú vagy 4-es méretű) szűrőpapírt a szűrőkosárba.

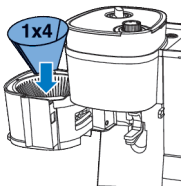

- 12** Zárja le a szűrőtartót.

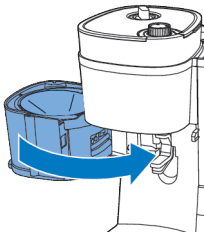

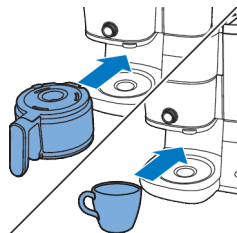

13 Helyezze a kávéskannát vagy a csészéjét a kifolyócső alá.

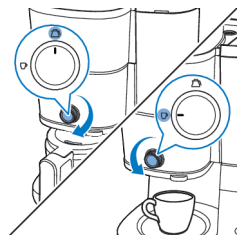

14 A gomb elforgatásával válassza ki a készítendő kávé mennyiségét.

A csészébe főzés funkció választása esetén egyaránt használhat üveg- vagy kerámiabögrét, illetve poharat. Ügyeljen arra, hogy 10 cm-nél alacsonyabb csészét használjon.

10 3



15 Kapcsolja be a készüléket.

1 3



16 A csésze gomb megnyomásával válassza ki, hogy hány csésze kávé szeretne készíteni.

1 2



17 A kívánt erősség kiválasztásához nyomja meg a kávéerősség gombot.

- 1: szemeskávét gyenge kávéhoz
- 2: szemeskávét közepesen erős kávéhoz
- 3: szemeskávét erős kávéhoz



18 Az indítás/szüneteltetés gomb megnyomásával indítsa el a folyamatot.

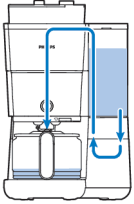

19 A készülék megkezdi a kávéfőzést.
- A készülék hangjelzést ad, amikor elkészült.

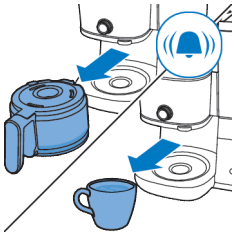

20 Távolítsa el a csészét vagy a kávéskannát a készülékről.

A cseppzáró funkció lehetővé teszi, hogy a kávékészítés befejeződése előtt levehesse a kannát a kávéfőzőről. A kanna eltávolításakor a cseppzáró rendszer megakadályozza, hogy kávé folyjon a kannába.

A kanna eltávolításakor a főzés nem áll le. Ha 20 másodpercen belül nem helyezi vissza a kannát a készülékbe, a szűrőkosár túlcordul.



21 Élvezze a frissen főtt kávé!

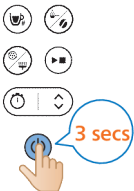

22 A készülék kikapcsolásához nyomja meg és 3 másodpercig tartsa nyomva az indítás/szüneteltetés gombot.

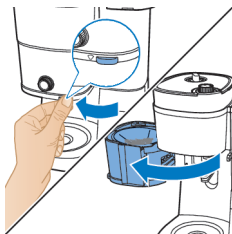

23 Nyissa ki a szűrőtartót.

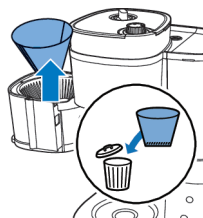

24 Távolítsa el a használt szűrőpapírt.

Egy vagy két csésze kávé főzésekor a melegen tartás funkció nem kapcsol be.

A készülék addig tartja forrón az italt, amíg automatikusan ki nem kapcsol. Ha nem szeretné, hogy az ital forró maradjon, a be-/kikapcsoló gomb megnyomásával kapcsolja ki a készüléket.

Előőrölt kávé használata

A használathoz kövesse az alábbi lépéseket:

- 1 Ellenőrizze, hogy a készülékben van-e elegendő víz a kívánt mennyiségű kávé elkészítéséhez.



- 2 Fogja meg a fület, és nyissa ki a szűrőtartót.

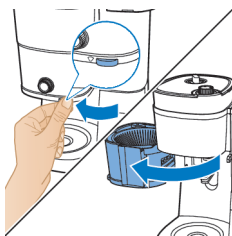

- 3 Tegyen (1x4 típusú vagy 4-es méretű) szűrőpapírt a szűrőkosárba.

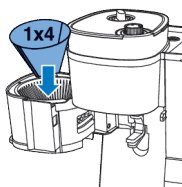

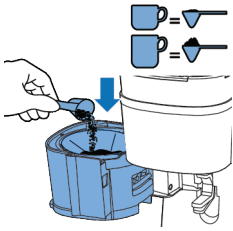

- 4 Tegyen az egyéni ízlésétől függően szükséges mennyiségű előőrölt kávé a szűrőpapírba.
- Egy átlagos csésze kávéhoz használjon 6 gramm vagy 1 evőkanál őrölt kávé.

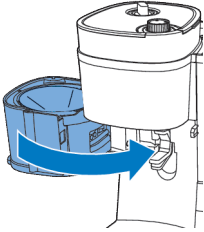

- 5 Zárja le a szűrőtartót.

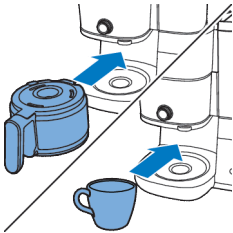

- 6 Helyezze a kávéskannát vagy a csészéjét a kifolyócsó alá.

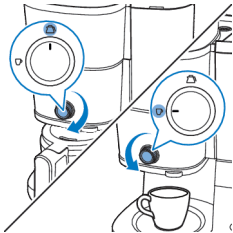

- 7 A gomb elforgatásával válassza ki a készítendő kávé mennyiségét.

WS 10 3

- 8 Kapcsolja be a készüléket.

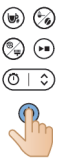



9 Az üzemmódváltató gombbal válassza ki az előőrölt kávé funkciót.

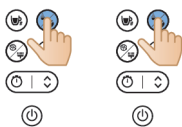

10 A csésze gomb megnyomásával válassza ki, hogy hány csésze kávé szeretne készíteni.

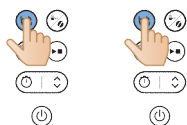

11 Az indítás/szüneteltetés gomb megnyomásával indítsa el a folyamatot.



12 A készülék megkezdi a kávéfőzést.
- A készülék hangjelzést ad, amikor elkészült.

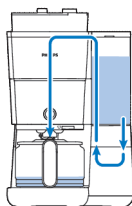

13 Távolítsa el a csészét vagy a kávéskannát a készülékről.

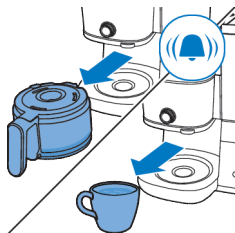



14 Élvezze a frissen főtt kávét!

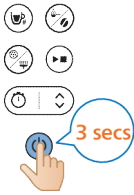

15 A készülék kikapcsolásához nyomja meg és 3 másodpercig tartsa nyomva az indítás/szüneteltetés gombot.

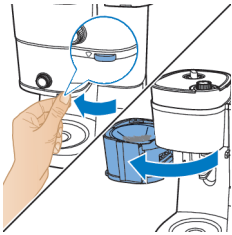

16 Nyissa ki a szűrőtartót.

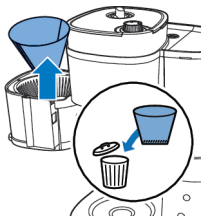

17 Távolítsa el a használt szűrőpapírt.

Az időzítő beállítása

A készülék időzítőjének beállításához kövesse az alábbi lépéseket:

1 Kapcsolja be a kávéfőzőt.

08:05



- 2 Nyomja meg az időzítő gombot; ekkor az időzítő ikonja megjelenik a kijelzőn. Az órát mutató számjegyek villognak, jelezve, hogy az óra beállítása történik.

08:00



- 3 Használja a nyíl gombot az óra beállításához. Ha gyorsan szeretné elvégezni a beállítást, nyomja hosszan a nyíl gombot.

08:



- 4 Nyomja meg az időzítő gombot az óra beállításának jóváhagyásához. A perc számjegyek villognak, és jelzik a perc beállítását.

08:05



- 5 Használja ismét a nyíl gombot a perc beállításához. Ha gyorsan szeretné elvégezni a beállítást, nyomja hosszan a nyíl gombot.

08:05



- 6 Nyomja meg ismét az időzítő gombot a perc beállításának jóváhagyásához. *Az időzítőből való kilépéshez egyszerűen nyomja meg az időzítő gombot. Ekkor az időzítő ikonja eltűnik a kijelzőről.*

A cseppzáró funkció lehetővé teszi, hogy a kávékészítés befejeződése előtt levehesse a kannát a kávéfőzőről. A kanna eltávolításakor a cseppzáró rendszer megakadályozza, hogy kávé folyjon a kannába.

Megjegyzés: A kanna eltávolításakor a főzés nem áll le. Ha 20 másodpercen belül nem helyezi vissza a kannát a készülékbe, a szűrőkosár túlcserélődik.

Tisztítás és karbantartás

Tisztítás minden használat után

Ne merítse a kávéfőzőt vízbe, vagy más folyadékba, és ne öblítse le folyóvízzel sem.

- 1 Húzza ki a hálózati dugót a fali konnektorból.

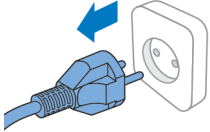









- 2 Nedves kendővel törölje le a kávéfőző burkolatát.
- 3 A szűrőkosarat tisztítsa le forró vízzel és egy kevés mosogatószerrel, vagy mosogassa el a mosogatógépben.



- 4 Öblítse el a csap alatt a kávéskannát és a fedelet. Vagy mosogassa el őket a mosogatógépben.

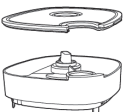

			
	✓	✓	✓
	✓	✓	✓
	✓	✓	✓
	✓	✗	✓
	✓	✗	✓

Az őrlőtölcsér tisztítása

Figyelem!

1-2 hetente tisztítsa meg az őrlőtölcsért, hogy ne tömődjön el őrölt kávéval. Az alábbi lépéseket követve egyszerűen és gyorsan elvégezheti ezt.

Tisztítsa meg az őrlőtölcsért, amikor a kijelzőn megjelenik a kefe figyelmeztetés.

Megjegyzés: A tisztítás megkezdése előtt győződjön meg arról, hogy a szemeskávé-tartály üres.

- 1 Csatlakoztassa a készülék hálózati dugóját a fali aljzatba.

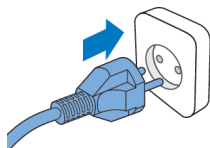

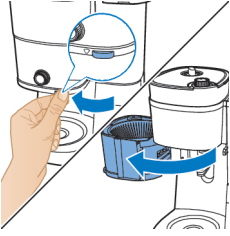

2 Nyissa ki a szűrőtartót, hogy hozzáférjen az őrölt kávé leeresztő tölcséréhez.

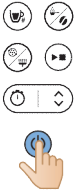

3 Kapcsolja be a kávéfőzőt.

4 Nyomja meg a kávéfőző kezelőpaneljén lévő tisztítás gombot.

5 A kijelzőn válassza a kefe beállítást.

ψ



6 Nyomja meg az indítás gombot. Ekkor kinyílik az őrölt kávé leeresztő tölcsérének retesze, így egy kefével ki tudja tisztítani a tölcsért.



7 Egy kefével távolítsa el a tölcsérben esetleg összegyűlt kávéőrleményt vagy maradványt.

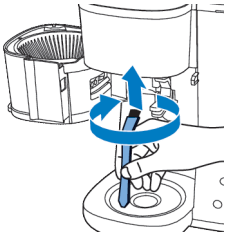



- 8 A tölcser megtisztítása után a retesz lezárásához nyomja meg ismét az indítás gombot.

A kávéfőző vízkőmentesítése

Vízkőmentesítse a kávéfőzőt, amikor a kijelzőn megjelenik a vízkőmentesítésre figyelmeztető riasztás. A vízkőmentesítéshez kizárólag fehér ecetet használjon, mivel más termékek károsíthatják a kávéfőzőt.

Figyelmeztetés: A készülék vízkőmentesítéséhez ne használjon 8%-os vagy annál magasabb ecetsav-tartalmú természetes ecetet, vízkőmentesítő port vagy tablettát, mivel ezek károsíthatják a készüléket.

- 1 Nyissa ki a víztartály fedelét.

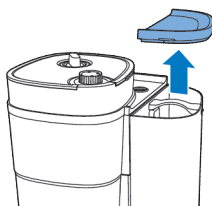

- 2 A 10 csésze jelig töltsé fel a víztartályt fehér ecettel (4%-os ecetsavval).

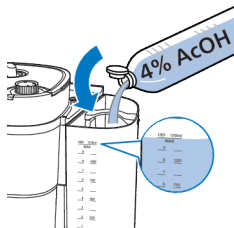

- 3 Zárja le a víztartály fedelét.

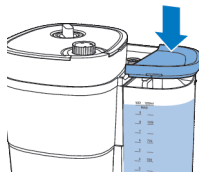

- 4 Fogja meg a fület, és nyissa ki a szűrőtartót.

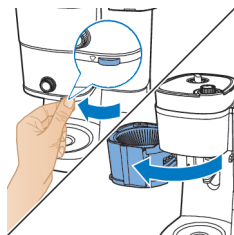

- 5 Tegyen (1x4 típusú vagy 4-es méretű) szűrőpapírt a szűrőkosárba, és zárja le a kosártartót.

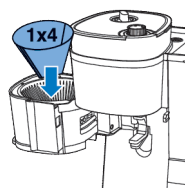

- 6 Helyezze az üres kávéskannát a kávéfőzőbe.
7 Csatlakoztassa a hálózati csatlakozódugót a fali aljzatba.

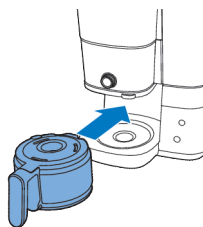

- 8 A bekapcsológomb megnyomásával kapcsolja be a kávéfőzőt. A kijelző világítani kezd.

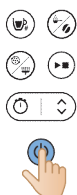

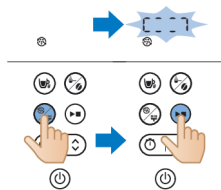

- 9 A kávéfőzőn nyomja meg a tisztítás gombot.
 10 Válassza ki a vízkömentesítés beállítását.
 11 A választás jóváhagyásához nyomja meg az indítás gombot.
 - A kávéfőző automatikusan megkezdje a vízkömentesítést.

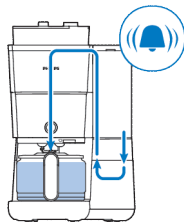

- 12 Várja meg, amíg a készülék befejezi a vízkömentesítő oldat forralását.
 13 Amikor a vízkömentesítés befejeződött, maximális mennyiségű vízzel kétszer öblítse át a készüléket, hogy minden lerakódást eltávolítson.

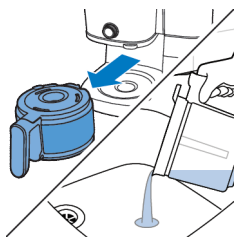

- 14 Ürítse ki a kannát, és távolítsa el a vízkömaradványokkal teli szűrőpapírt.
 15 Töltse meg a víztartályt friss hideg vízzel, és nyomja meg az indítás gombot a következő főzés elindításához.
 Hagyja, hogy a kávéfőző elvégezze a teljes főzési folyamatot, majd ürítse ki a kannát.

Megjegyzés: Ha szükséges, ismételje a 14. lépést addig, amíg a kávéfőzőből kifolyó víznek már nincs többé ecetszaga vagy -íze.

- 16 Forró vízzel és egy kevés mosogatószerrel tisztítsa meg a szűrőkosarat és a kannát.
 17 A bekapcsoló gombbal kapcsolja ki a készüléket.

Hibaelhárítás

Ez a fejezet a készülékkel kapcsolatban leggyakrabban felmerülő problémák összefoglalását tartalmazza. Ha az alábbi útmutató segítségével nem tudja elhárítani a hibát, látogasson el a www.philips.com/support weboldalra a gyakran ismétlődő kérdések listájáért, vagy forduljon az országában illetékes vevőszolgálathoz.

További online támogatásért beolvashatja ezt a QR-kódot is.



Probléma

A kávéfőző nem működik.

Megoldás

Csatlakoztassa a hálózati kábelt, és a be-/kikapcsoló gombbal kapcsolja be a kávéfőzőt.

Győződjön meg róla, hogy a kávéfőzőn feltüntetett feszültség értéke megegyezik a helyi hálózati feszültséggel.

Töltse fel a víztartályt vízzel.

Zárja le az őrlőtölcsér fedelét.

Az őrlő nem működik, vagy nem megfelelően működik.

Ellenőrizze, hogy nem az előőrölt kávé lehetőséget választotta-e. Ha a kijelzőn az előőrölt kávé ikonja látható, az előőrölt kávé lehetőséget választotta ki.

Az alábbi utasításokat követve tisztítsa ki az őrlőtölcsért.

Amikor az őrlőt használom, a kávé túl gyenge lesz.

A kávéerősség gomb elforgatásával válasszon a finomabb-durvább őrléstípusok közül az ízlésének megfelelően.

A kávéerősség-választó gombbal 1-es és 3-as érték között választhatja ki a kávé erősségét; a nagyobb érték erősebb kávét jelent.

Használjon erősebb aromájú szemeskávét vagy erősebb kávéfajtákat tartalmazó keveréket.

Amikor előőrölt kávét használok, a kávé túl gyenge lesz.

Ügyeljen arra, hogy a szűrőben lévő előőrölt kávé mennyisége összhangban legyen a víztartályban lévő víz mennyiségével. Vegye figyelembe, hogy a kávéfőző a víztartályban lévő összes vizet felhasználja.

Használjon erősebb aromájú őrlött kávét vagy erősebb kávéfajtákat tartalmazó keveréket.

Erősebb kávéhoz növelje az őrlött kávé mennyiségét, vagy használjon kevesebb vizet.

A szűrő túlcsoordul, ha kávéfőzés közben a kannát leveszem a kávéfőzőről.

Ha a kannát 20 másodpercnél hosszabb időre távolítja el kávéfőzés közben, a cseppzáró rendszer miatt a szűrőkosár túlcsoordul. Ne feledje azt sem, hogy a kávé csak a főzési folyamat végeztével nyeri el teljes zamatát. Ezért azt tanácsoljuk, hogy csak a kávéfőzés végeztével vegye el a kannát és öntsön ki belőle kávét.

A kávéfőző jóval a kávéfőzés végét követően is tovább csöpög.

A csöpögést a gőz lecsapódása okozza. Teljesen normális, ha a készülék csöpög egy ideig.

Folyamatosan csöpög a kávé.

A cseppzáró funkció bekapcsolásához állítsa át a gombot csésze üzemmódból kanna üzemmódba; a cseppzáró megakadályozza, hogy kávé csepegjen a szűrőkosárból.

Ha a csepegés továbbra sem szűnik meg, a cseppzáró valószínűleg eltömődött. A cseppzáró megtisztításához nyissa ki a szűrőkosár tartóját, és vegye ki a szűrőkosarat. Forró folyóvízzel öblítse ki a szűrőkosarat és a cseppzárót.

A kávé nem elég forró.

A kannában lévő kávé hamarabb kihűl, ha csak néhány csészenyi kávét főz. A kávé tovább marad forró, ha egy teljes kannányi, vagyis 10 csészenyi kávét főz.

Vízkömentesítse a kávéfőzőt.

A szemeskávé túl gyorsan elfogy.

A tökéletes csésze kávé elkészítéséhez egy adott mennyiségű őrölt kávé tenni a kávéfőzőbe tenni. A kávéfőző a csészénként szükséges optimális mennyiségű őrölt kávé elkészítéséhez normál mennyiségű szemeskávét használ fel.

Az időzítő nem működik.

Az időzítő beállítása előtt ellenőrizze, hogy a szemeskávével vagy előőrölt kávéval történő kávéfőzés összes lépését végrehajtotta-e.

Hibakód

Hibakód	Leírás	Megoldás	Megjegyzés
E1	Kevés víz	Nyomja meg bármelyik gombot a készülék készenléti üzemmódba állításához. Töltse fel ismét a víztartályt, majd indítsa újra a készüléket.	Ha a probléma továbbra is fennáll, hajtsa végre az alábbi lépéseket: Nyomja meg, és 3 másodpercig tartva nyomva egyszerre a tisztítás és az indítás gombot, amíg a készülék automatikusan nem kezdi el 1 percig szivattyúzni a vizet. Ismétlje meg háromszor ezt a lépést. Ha a probléma továbbra is fennáll, vegye fel a kapcsolatot az ügyfélszolgálattal.
E2	A szemeskávé-tartály nem elérhető	Nyomja meg bármelyik gombot a készülék készenléti üzemmódba állításához. Szerelje fel stabilan a szemeskávé-tartályt, és indítsa újra a készüléket	Ha a probléma továbbra is fennáll, vegye fel a kapcsolatot az ügyfélszolgálattal.
E3	A fűtőcső hibásan működik	Húzza ki a készülék hálózati dugóját a fali aljzatból. Miután teljesen lehűlt a készülék, ismét csatlakoztassa a hálózathoz, és kapcsolja be.	Ha a probléma továbbra is fennáll, vegye fel a kapcsolatot az ügyfélszolgálattal.
E4	Az őrlőtárcsa eltömődött	Húzza ki a készülék hálózati dugóját a fali aljzatból. Csatlakoztassa a hálózathoz, és kapcsolja be ismét a készüléket. Az őrlőtárcsa és az őrölt kávé leeresztő tölcserének kitisztításához kövesse „Az őrlőtölcser tisztítása” című részben ismertetett lépéseket.	Ha a probléma továbbra is fennáll, vegye fel a kapcsolatot az ügyfélszolgálattal.

E5	Az őrölt kávé leeresztő tölcseré eltömődött	Húzza ki a készülék hálózati dugóját a fali aljzatból. Csatlakoztassa a hálózathoz, és kapcsolja be ismét a készüléket. Az őrölt kávé leeresztő tölcserének kitisztításához kövesse „Az őröltöltés tisztítása” című részben ismertetett lépéseket.	Ha a probléma továbbra is fennáll, vegye fel a kapcsolatot az ügyfélszolgálattal.
E6/E7/ E8	Programhiba	Húzza ki a készülék hálózati dugóját a fali aljzatból. Csatlakoztassa a hálózathoz, és kapcsolja be ismét a készüléket.	Ha a probléma továbbra is fennáll, vegye fel a kapcsolatot az ügyfélszolgálattal.

Introductie

Gefeliciteerd met uw aankoop en welkom bij Philips!

Registreer uw product op www.philips.com/welcome om optimaal gebruik te kunnen maken van de door Philips geboden ondersteuning.

Algemene beschrijving

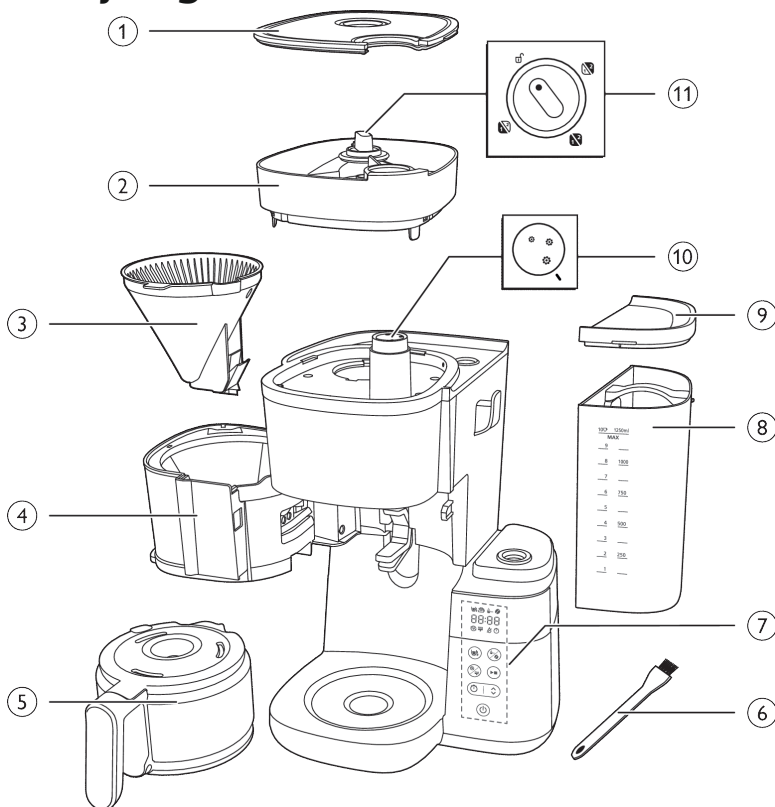

- 1 Deksel koffiebonenreservoir
- 2 Koffiebonenreservoir
- 3 Filtermand
- 4 Filtermandhouder
- 5 Glazen kan
- 6 Schoonmaakborsteltje voor bonentrechter
- 7 Bedieningspaneel met display
- 8 Waterreservoir
- 9 Deksel waterreservoir
- 10 Maalgraadknop
- 11 Reservoirselectieknop

Bedieningspaneel



Aan-uitknop



Timerknop en pijltjestoets om de tijd aan te passen



Start-/stopknop



Reinigingsknop



Knop voor voorgemalen koffie en koffiesterkte



Selectieknoppen voor koppen

Pictogram op display



Aantal koppen



Warmhoudmodus



Voorgemalen koffie



Koffiesterkte



Ontkalken



Waarschuwing handmatig reinigen



Laag waterniveau



Timer



Tijdsweergave

De eerste twee cijfers geven het uur aan en de laatste twee cijfers de minuten.



Draai de knop naar de ontgrendelde positie en verwijder het koffiebonenreservoir uit het apparaat.



Met deze knop kunt u de maalgraad selecteren, waarbij een hogere graad voor een grovere maling zorgt.



Kanmodus

De druppelstopfunctie is actief in de kanmodus.

Opmerking: het koffiezetproces stopt niet wanneer u de kan verwijdert. Als u de kan niet binnen twintig seconden terugzet in het apparaat, loopt de filtermand over.



Kopmodus

Schakel de knop handmatig over van kopmodus naar kanmodus om de druppelstop te activeren, zodat het druppelen stopt wanneer het koffiezetproces is afgerond.

Opmerking: koude, keramische koppen nemen warmte van de koffie op. Voorkom dit door de koppen voor te verwarmen met heet water.

Belangrijk

Waarschuwing

- Controleer of het voltage dat wordt aangegeven op het apparaat overeenkomt met de plaatselijke netspanning voordat u het apparaat aansluit.
- Sluit het apparaat aan op een geaard stopcontact.
- Gebruik het apparaat niet indien de stekker, het netsnoer of het apparaat zelf beschadigd is.
- Indien het netsnoer beschadigd is, moet het worden vervangen door Philips, een door Philips geautoriseerd servicecentrum of personen met vergelijkbare kwalificaties om gevaar te voorkomen.
- Dit apparaat kan worden gebruikt door kinderen vanaf 8 jaar en door personen met verminderde lichamelijke, zintuiglijke of geestelijke capaciteiten of met weinig ervaring en kennis, mits zij onder toezicht staan of instructies hebben gekregen over veilig gebruik van het apparaat, en zij de gevaren van het gebruik begrijpen. Reiniging en onderhoud mogen alleen door kinderen worden uitgevoerd die ouder zijn dan 8 en alleen onder toezicht. Houd het apparaat en het snoer buiten bereik van kinderen die jonger zijn dan 8 jaar.
- Kinderen mogen niet met het apparaat spelen.
- Laat het netsnoer niet hangen over de rand van de tafel of het aanrecht waarop het apparaat staat.

- Gebruik dit apparaat alleen voor het beoogde doeleinde om gevaren of letsel te voorkomen.

Let op

- Spoel het apparaat vóór het eerste gebruik altijd af met vers water.
- Plaats het apparaat nooit op een hete ondergrond en laat het netsnoer nooit in aanraking komen met hete oppervlakken.
- Plaats het apparaat niet in een kast tijdens gebruik.
- Haal de stekker van het apparaat uit het stopcontact voordat u het apparaat gaat reinigen en wanneer er zich problemen voordoen tijdens het koffiezetten.
- Reinig het apparaat altijd wanneer het apparaat is afgekoeld.
- Tijdens het koffiezetten en het warmhouden van de koffie worden het waterreservoir, de filterhouder, de warmhoudplaat, het onderste deel van het apparaat en de kan met koffie warm, en ze kunnen ook nog enige tijd warm blijven.
- Plaats de kan niet op een fornuis of in een magnetron om de koffie opnieuw op te warmen.
- Dit apparaat is bedoeld voor huishoudelijk en soortgelijk gebruik, bijvoorbeeld in boerderijen; in Bed & Breakfast-achtige omgevingen; in keukens (voor personeel) in winkels, kantoren en andere werkomgevingen; en door gasten in hotels, motels en andere verblijfsaccommodaties.
- Breng het apparaat altijd naar een door Philips geautoriseerd servicecentrum voor onderzoek of reparatie. Probeer het apparaat niet zelf te openen of te repareren.
- Het oppervlak van het warmte-element, de filterhouder, het onderste deel van het apparaat, de warmhoudplaat en de kan met koffie kunnen na gebruik nog een tijd restwarmte uitstralen.
- Tenzij anders aangegeven, is al het verpakkingsmateriaal in de doos gemaakt van gerecycled papier; zie de PAP-markering op de doos.

Ontkalken

- Ontkalk het koffiezetapparaat wanneer de waarschuwing voor ontkalken op het display verschijnt. Gebruik alleen witte azijn om te ontkalken. Andere middelen kunnen het apparaat mogelijk beschadigen.

Elektromagnetische velden (EMV)

Dit Philips-apparaat voldoet aan de richtlijnen met betrekking tot elektromagnetische velden (EMV).

Recycling



Dit symbool betekent dat dit product niet bij het gewone huishoudelijke afval mag worden weggegooid (2012/19/EU).

Volg de in uw land geldende regels voor de gescheiden inzameling van elektrische en elektronische producten. Met correcte afvoer voorkomt u negatieve gevolgen voor het milieu en de volksgezondheid.

Tenzij anders aangegeven, is al het verpakkingsmateriaal in de doos gemaakt van gerecycled papier; zie de PAP-markering op de doos.

Garantie en ondersteuning

Versuni biedt twee jaar garantie op dit product vanaf de datum van aankoop. Deze garantie is niet geldig als een defect het gevolg is van onjuist gebruik of slecht onderhoud. Onze garantie is niet van invloed op uw rechten als consument. Ga voor meer informatie of om de garantie in te roepen naar onze website www.philips.com/support.

Voor het eerste gebruik

Reinig de filterhouder en het permanente filter na elk gebruik.

Veeg de filterhouder grondig schoon met een droge doek na elk gebruik. Reinig alle opgehoopte condensatie.

De klok instellen

- 1 Steek de stekker van het apparaat in het stopcontact.
 - Het urendisplay gaat knipperen.

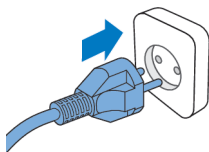

08:00



- 2 Gebruik de pijltjestoets om de uren aan te passen.

08: ((🔔))



3 Zodra het uur is ingesteld, drukt u op de timerknop om het uur te bevestigen.

08:06



4 De minutenindicatie gaat knipperen. Gebruik de pijltjestoets om de minuten aan te passen.

08:06 ((🔔))



5 Druk op de timerknop om de minuten te bevestigen.



08:06

- De huidige tijd is nu ingesteld en opgeslagen.

6 U kunt de timer op twee manieren aanpassen in de stand-bymodus:

- Haal de stekker uit het stopcontact en steek het er weer in.
- Houd de timerknop ingedrukt totdat de urcijfers knipperen.

Opmerking

Het apparaat slaat altijd de laatste instelling op.

Warmhoudtijd

U kunt instellen hoe lang de koffie warm wordt gehouden na het zetten door in te stellen wanneer het apparaat automatisch wordt uitgeschakeld. Het apparaat wordt standaard na 30 minuten automatisch uitgeschakeld. Het wordt uiterlijk na 300 minuten automatisch uitgeschakeld.

Volg de onderstaande stappen om in te stellen wanneer het apparaat automatisch wordt uitgeschakeld:

- 1 Schakel het apparaat uit en houd de stekker in het stopcontact.
- 2 Houd de reinigingsknop ingedrukt totdat het pictogram warmhouden wordt weergegeven en het uur begint te knipperen.
- 3 Volg de stap voor 'De klok instellen' om het instellen te voltooien.

Het apparaat spoelen

Spoel het koffiezetapparaat altijd vóór het eerste gebruik door de onderstaande stappen te volgen:

Waarschuwing: giet nooit water in het koffiebonenreservoir, aangezien dit het apparaat kan beschadigen.

1 Open het deksel van het waterreservoir.

Let op: plaats geen koffiebonen of voorgeمالen koffie in het waterreservoir

2 U kunt het waterreservoir op twee manieren vullen met water:

- Til het reservoir uit het apparaat en houd het onder de kraan om het met water te vullen.

- Zorg ervoor dat de haak correct is bevestigd voordat u het reservoir terugplaatst.

- Gebruik de dekselgreep om het deksel van de kan te openen. Plaats de koffiekan onder kraan om hem met water te vullen. Vul het waterreservoir met behulp van de koffiekan.

- Zorg ervoor dat het water onder het maximumniveau blijft.

3 Sluit het deksel van het waterreservoir.

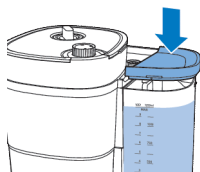
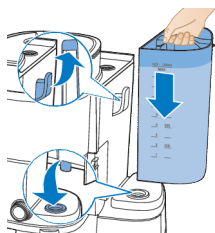
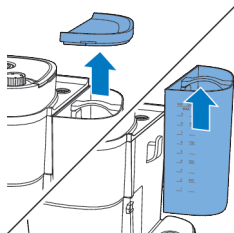

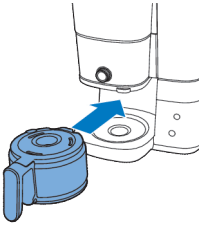

4 Plaats de koffiekan in het apparaat.

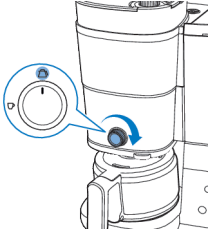

5 Draai de middelste knop naar de kaninstelling.



6 Druk op de aan-uitknop.
- Het apparaat is ingeschakeld.



7 Druk op de knop voor koffiesterkte en selecteer voorgemalen koffie.

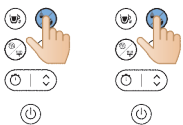

8 Druk op de kopknop en selecteer 10 koppen.

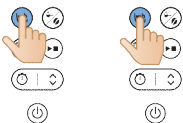



9 Druk op de startknop.

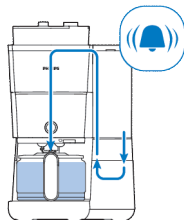

10 Het apparaat start het spoelproces.

11 Laat het apparaat werken totdat het spoelproces is voltooid.

12 Leeg de glazen kan.

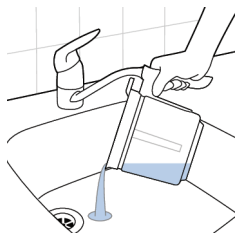

Het apparaat gebruiken

Koffiebonen gebruiken

Opmerking: het koffiezetapparaat gebruikt net zo veel water als nodig is om het geselecteerde aantal koppen te zetten

Volg de onderstaande stappen om het te gebruiken:

1 Open het deksel van het waterreservoir en haal het reservoir uit het apparaat.

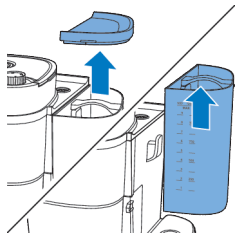

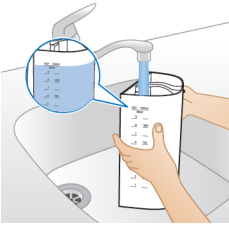

- 2 Vul het reservoir met kraanwater.
- Zorg ervoor dat het water onder het maximumniveau blijft.

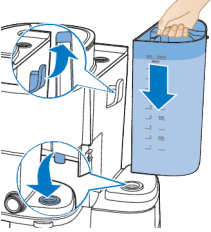

- 3 Plaats het reservoir terug in het apparaat.
- Zorg ervoor dat de haak correct is bevestigd.

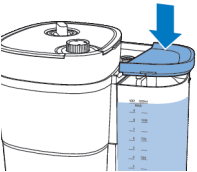

- 4 Sluit het deksel van het waterreservoir.

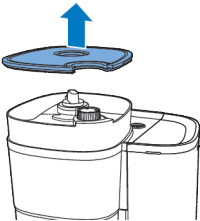

- 5 Til de klep van het koffiebonenreservoir op.

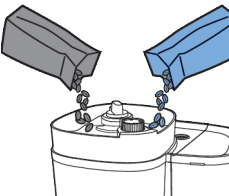

- 6 Vul het reservoir met de gewenste koffiebonen.

Opmerking: zorg ervoor dat het koffiebonenreservoir altijd minimaal voor de helft is gevuld.

Waarschuwing: gebruik geen niet-geroosterde of gekarameliseerde bonen om te voorkomen dat de maalmolen vastloopt. Gebruik koffiebonen en geen espressobonen, aangezien die de maalmolen kunnen beschadigen.

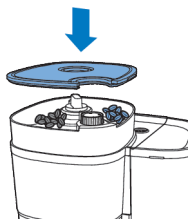

7 Sluit het deksel van het koffiebonenreservoir.

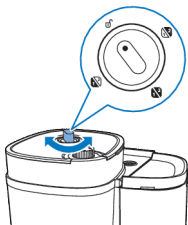

8 Draai de reservoirselectieknop om het reservoir met de gewenste koffiebonen te selecteren.

- U kunt ook twee verschillende soorten koffiebonen mengen voor een unieke blend.

Opmerking: als u wisselt tussen koffiebonenreservoirs of andere koffiebonen gebruikt, blijven er altijd restanten van de eerder gemalen koffiebonen achter in het apparaat. Reinig de maalmolentrichter nadat u nieuwe koffiebonen hebt geselecteerd om dit te voorkomen.

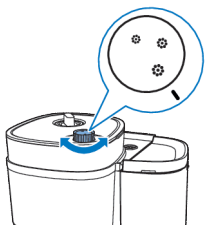

9 Kies de gewenste maalgraad met behulp van de knop.

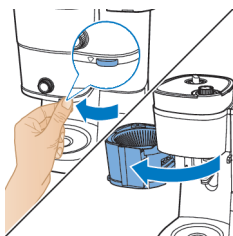

10 Open de filterhouder met behulp van de greep.

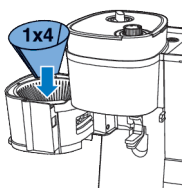

11 Plaats een papieren filter (type 1x4 of nr. 4) in de filtermand.

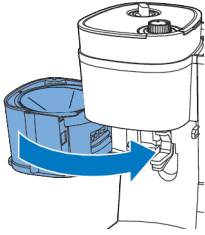

12 Sluit de filterhouder

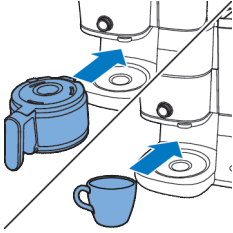

13 Plaats de koffiekkan of uw kop onder de dispenser.

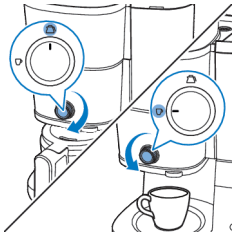

14 Gebruik de knop om te selecteren hoeveel koffie u wilt zetten.

Wanneer u de kopfunctie gebruikt, kunt u glazen of keramische mokken gebruiken, of glazen. Zorg ervoor dat de koppen maximaal 10 cm hoog zijn.

W 3



15 Schakel het apparaat in.

16 Selecteer het aantal koppen dat u wilt door op de kopknop te drukken.



17 Druk op de knop voor koffiesterkte om de gewenste koffiesterkte te kiezen.

- 1: bonen voor milde koffie
- 2: bonen voor koffie met gemiddelde sterkte
- 3: bonen voor sterke koffie

18 Start de bereiding door op de start-/pauzeknop te drukken.



19 Het apparaat begint met het koffiezetten.

- Het apparaat piept wanneer het klaar is.

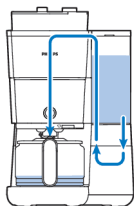

20 Haal uw kop of de koffiekkan uit het apparaat.

Met de druppelstopfunctie kunt u de kan uit het koffiezetapparaat halen voordat alle koffie is gezet.. Wanneer u de kan verwijdert, voorkomt de druppelstop dat de koffie doorstroomt.

het koffiezetproces stopt niet wanneer u de kan verwijdert. Als u de kan niet binnen twintig seconden terugzet in het apparaat, loopt de filtermand over.

21 Geniet van uw verse koffie.





22 Schakel het apparaat uit door de start-/stopknop drie seconden ingedrukt te houden.

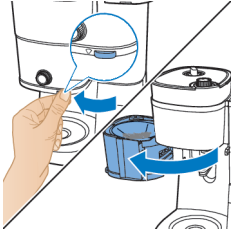

23 Open de filterhouder.

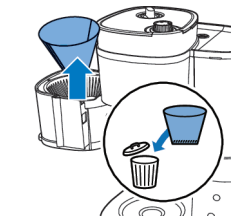

24 Verwijder het gebruikte papieren filter.

De warmhoudfunctie wordt niet geactiveerd wanneer u één of twee koppen zet.

Uw apparaat houdt u koffie warm totdat de functie automatisch wordt uitgeschakeld. Als u de warmhoudfunctie wilt uitschakelen, drukt u op de aan/uitknop om het apparaat uit te schakelen.

Voorgemalen koffie gebruiken

Volg de onderstaande stappen om het te gebruiken:

1 Controleer of het apparaat genoeg water heeft om de gewenste hoeveelheid koffie te zetten.



2 Open de filterhouder met behulp van de greep.

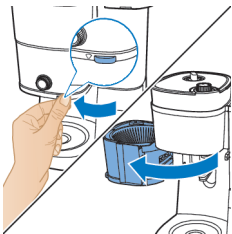

3 Plaats een papieren filter (type 1x4 of nr. 4) in de filtermand.

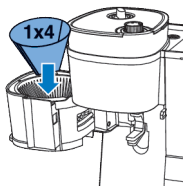

4 Voeg voldoende voorgemalen koffie toe aan het papieren filter, afhankelijk van uw persoonlijke voorkeur.

- Voor een reguliere kop koffie gebruikt u 6 gram gemalen koffie of één eetlepel.

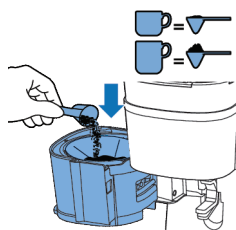

5 Sluit de filterhouder.

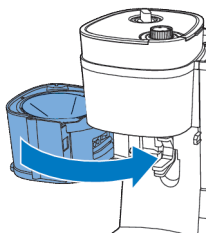

6 Plaats de koffiekkan of uw kop onder de dispenser.

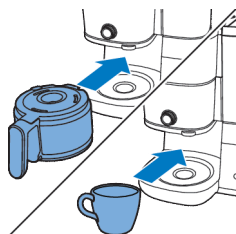

7 Gebruik de knop om te selecteren hoeveel koffie u wilt zetten.

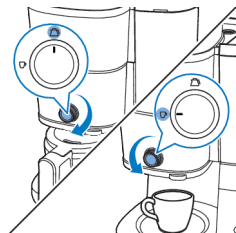



8 Schakel het apparaat in.



9 Kies voorgemalen koffie door op de modeselectieknop te drukken.

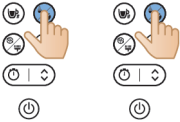

10 Selecteer het aantal koppen dat u wilt door op de kopknop te drukken.

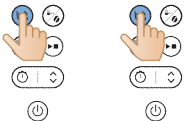

11 Start de bereiding door op de start-/pauze knop te drukken.



12 Het apparaat begint met het koffiezetten.

- Het apparaat piept wanneer het klaar is.

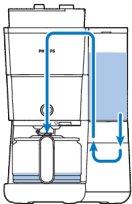

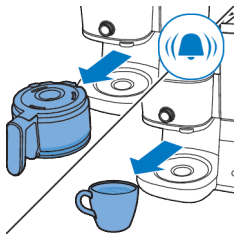

13 Haal uw kop of de koffiekan uit het apparaat.



14 Geniet van uw verse koffie.

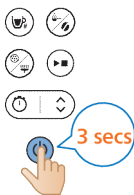

15 Schakel het apparaat uit door de start-/stopknop drie seconden ingedrukt te houden.

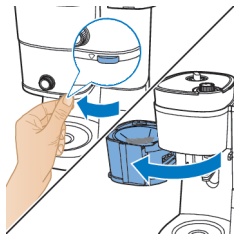

16 Open de filterhouder.

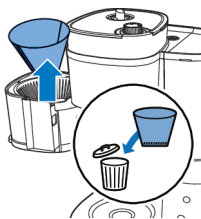

17 Verwijder het gebruikte papieren filter.

De timer instellen

Volg deze stappen om de timer op het apparaat in te stellen:

- 1 Schakel het koffiezetapparaat in.
- 2 Druk op de timerknop. Het timerpictogram verschijnt op het display. De uurscijfers gaan knipperen om aan te geven dat het uur kan worden ingesteld.

08:06 



- 3 Gebruik de pijltjestoets om de uren aan te passen. Als u de tijd sneller wilt aanpassen, houdt u de pijltjestoets ingedrukt.

08:00



- 4 Druk op de timerknop om de ingestelde tijd te bevestigen. De minutencijfers geven aan dat de minuten kunnen worden ingesteld.

08: 



- 5 Gebruik weer de pijltjestoets om de minuten aan te passen. Als u de tijd sneller wilt aanpassen, houdt u de pijltjestoets ingedrukt.

08:06



08:05



- 6 Druk nogmaals op de timerknop om de ingestelde tijd te bevestigen.

Als u de timer wilt annuleren, drukt u op de timerknop. Het timerpictogram verdwijnt dan van het display.

Met de druppelstopfunctie kunt u de kan uit het koffiezetapparaat halen voordat alle koffie is gezet.. Wanneer u de kan verwijdert, voorkomt de druppelstop dat de koffie doorstroomt.

Opmerking: het koffiezetproces stopt niet wanneer u de kan verwijdert. Als u de kan niet binnen twintig seconden terugzet in het apparaat, loopt de filtermand over.

Reiniging en onderhoud

Reinigen na elk gebruik

Dompel het koffiezetapparaat nooit in water of een andere vloeistof en spoel deze ook niet onder de kraan af.

- 1 Haal de stekker uit het stopcontact.

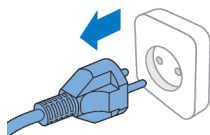









- 2 Veeg de binnenkant van het koffiezetapparaat schoon met een vochtige doek.

- 3 Reinig de filtermand met heet water en wat afwasmiddel, of reinig de mand in de vaatwasser.



- 4 Reinig de koffiekan en het deksel onder de kraan. Of reinig ze in de vaatwasser.

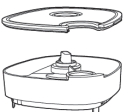

			
	✓	✓	✓
	✓	✓	✓
	✓	✓	✓
	✓	✗	✓
	✓	✗	✓

De maalmolentrichter reinigen

Belangrijk:

Reinig de maalmolentrichter elke 1 tot 2 weken om te voorkomen dat die verstopt raakt door gemalen koffie. Dit is eenvoudig en snel te doen met behulp van de onderstaande stappen.

Reinig de maalmolentrichter wanneer de reinigingswaarschuwing op het display wordt weergegeven.

Opmerking: controleer of het koffiebonenreservoir leeg is voordat u begint met reinigen.

- 1 Steek de stekker van het apparaat in het stopcontact.

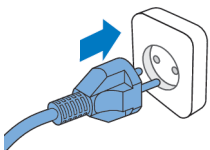

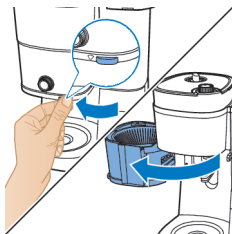

2 Open de filterhouder om bij de trechter voor gemalen koffie te kunnen.

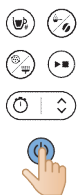

3 Schakel het koffiezetapparaat in.

4 Druk op de reinigingsknop op het bedieningspaneel van het apparaat.

5 Selecteer de borstelinstelling op het display.

⌵



6 Druk op de startknop. Hierdoor gaat de klep van de trechter voor gemalen koffie open, zodat u de trechter met een borsteltje kunt reinigen.



7 Gebruik een borsteltje om gemalen koffie of restanten weg te vegen die in de trechter zijn opgebouwd.

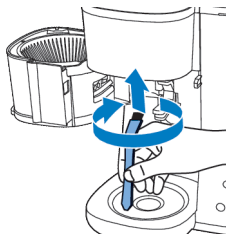

- 8 Nadat u de trechter hebt gereinigd, drukt u opnieuw op de startknop om de klep te sluiten.



Het koffiezetapparaat ontkalken

Ontkalk het koffiezetapparaat wanneer de waarschuwing voor ontkalken op het display verschijnt. Gebruik alleen witte azijn om te ontkalken. Andere middelen kunnen het koffiezetapparaat mogelijk beschadigen.

Waarschuwing: gebruik nooit azijn met een zuurgehalte van meer dan 8%, natuurlijke azijn, of ontkalkingsmiddelen in poeder- of tabletvorm om het apparaat te ontkalken, aangezien u daarmee het apparaat mogelijk kunt beschadigen.

- 1 Open het deksel van het waterreservoir.

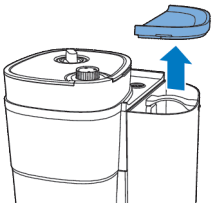

- 2 Vul het waterreservoir met witte azijn (zuurgehalte van 4%) tot aan de indicatie voor 10 koppen.

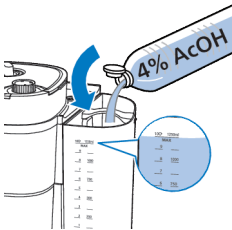

3 Sluit het deksel van het waterreservoir.

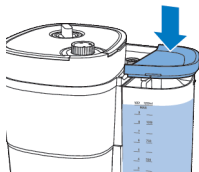

4 Open de filterhouder met behulp van de greep.

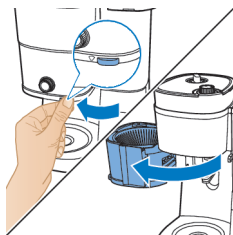

5 Plaats een papieren filter (type 1x4 of nr. 4) in de filtermand en sluit de filtermandhouder.

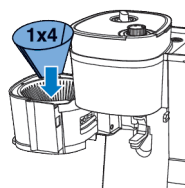

6 Zet de lege kan in het koffiezetapparaat.

7 Steek de stekker in het stopcontact.

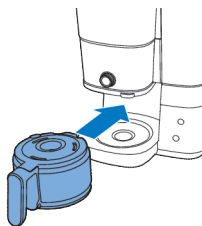

8 Druk op de aan-uitknop om het koffiezetapparaat in te schakelen. Het display gaat branden.

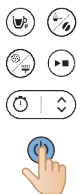

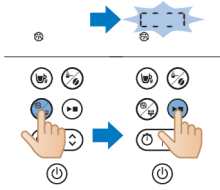

- 9 Druk op de reinigingsknop op het koffiezetapparaat.
- 10 Selecteer de instelling ontkalken.
- 11 Druk op de startknop om uw selectie te bevestigen.
 - Het koffiezetapparaat begint automatisch met het ontkalken.

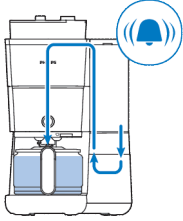

- 12 Wacht tot het apparaat het ontkalkingsmiddel heeft verwerkt.
- 13 Zodra het ontkalken is voltooid, reinigt u het apparaat tweemaal met de maximale hoeveelheid water om alle restanten te verwijderen.



- 14 Leeg de kan en verwijder het papieren filter met de kalkresten.
- 15 Vul het waterreservoir met vers, koud water en druk op de startknop om het apparaat te starten.

Laat het koffiezetapparaat het proces volledig afronden en leeg vervolgens de kan.

Opmerking: herhaal indien nodig stap 14 totdat het water dat uit het koffiezetapparaat komt, niet meer naar azijn smaakt of ruikt.

- 16 Reinig de filtermand en de kan met heet water en wat afwasmiddel.
- 17 Druk op de aan-uitknop om het apparaat uit te schakelen.

Problemen oplossen

Dit hoofdstuk behandelt in het kort de problemen die u kunt tegenkomen tijdens het gebruik van het apparaat. Als u het probleem niet met de onderstaande informatie kunt oplossen, gaat u naar www.philips.com/support voor een lijst met veelgestelde vragen of neemt u contact op met het Consumer Care Centre in uw land.

U kunt ook deze QR-code scannen voor meer online ondersteuning.



Probleem

Het koffiezetapparaat werkt niet.

Oplossing

Steek de stekker in het stopcontact en druk op de aan-uitknop om het koffiezetapparaat in te schakelen.

Controleer of het voltage op het koffiezetapparaat overeenkomt met de plaatselijke netspanning.

Vul het waterreservoir met water.

Sluit het deksel van de maalmolentrichter.

De maalmolen werk niet of niet goed.

Controleer of u niet voorgemalen koffie hebt geselecteerd. Als het symbool voor voorgemalen koffie op het display wordt weergegeven, hebt u voorgemalen koffie geselecteerd.

Reinig de maalmolentrichter door de instructies te volgen.

Wanneer ik de maalmolen gebruik, is de koffie niet sterk genoeg.

Draai de maalgraadknop om de gewenste maalgraad te selecteren, van fijn gemalen tot grof gemalen.

Gebruik de knop voor koffiesterkte om de koffiesterkte in te stellen van 1 tot 3. Hoe hoger het getal, hoe sterker de koffie.

Gebruik koffiebonen met een sterkere blend of smaak.

Wanneer ik voorgemalen koffie gebruik, is de koffie niet sterk genoeg.

Zorg ervoor dat de hoeveelheid voorgemalen koffie in het filter overeenkomt met de hoeveelheid water in het waterreservoir. Onthoud dat het koffiezetapparaat al het water in het waterreservoir gebruikt.

Gebruik gemalen koffie of een sterkere blend of smaak.

Als u sterkere koffie wilt, voegt u meer voorgemalen koffie toe of voegt u minder water toe.

Het filter overstroomt wanneer ik de kan uit het koffiezetapparaat verwijder tijdens het koffiezetten.

Als u de kan langer dan twintig seconden verwijdert tijdens de bereiding, zorgt de druppelstop ervoor dat de filtermand kan overlopen. Vergeet ook niet dat de koffie pas de bedoelde smaak behaalt wanneer het zetproces is afgerond. Daarom adviseren we om de kan niet te verwijderen en geen koffie in te schenken voordat het apparaat klaar is met koffiezetten.

Het koffiezetapparaat blijft druppelen, ook lang nadat het koffiezetten is afgerond.

Het druppelen wordt veroorzaakt door de condensatie van stoom. Het is volstrekt normaal dat het koffiezetapparaat nog even blijft doordruppelen.

Ik kan niet wachten tot de laatste druppels.

Draai de knop van kopmodus naar kanmodus om de druppelstopfunctie in te schakelen. De druppelstop voorkomt dat er koffie in de filtermand druppelt.

Als het druppelen niet stopt, is de druppelstop mogelijk verstopt. Open de filtermandhouder en haal de filtermand eruit om de druppelstop te reinigen. Reinig de filtermand en de druppelstop onder de kraan.

De koffie is niet warm genoeg.

De koffie in de kan koelt sneller af als u slechts een paar koppen zet. De koffie blijft langer warm als u tien koppen zet, wat neerkomt op een volle kan.

Het koffiezetapparaat ontkalken

De koffiebonen lijken snel op te gaan.

Voor de perfecte kop koffie heeft het koffiezetapparaat een bepaalde hoeveelheid gemalen koffie nodig. De hoeveelheid koffiebonen die het koffiezetapparaat gebruikt om de optimale hoeveelheid gemalen koffie te verkrijgen, is normaal.

De timer werkt niet.

Zorg ervoor dat u alle stappen voor het koffiezetten met koffiebonen of voorgemalen koffie hebt doorlopen voordat u de timer instelt.

Foutcode

Foutcode	Beschrijving	Oplossing	Opmerking
E1	Watertekort	Druk op een willekeurige knop om het apparaat in de stand-bymodus te zetten. Vul het waterreservoir opnieuw en start het apparaat opnieuw op.	Als dit probleem zich blijft voordoen, volgt u deze stappen: Houd de reinigings- en startknop tegelijkertijd voor drie seconden ingedrukt, totdat het apparaat automatisch een minuut lang water begint te pompen. Herhaal dit proces drie keer. Neem contact op met de klantenservice als dit probleem zich blijft voordoen.
E2	Koffiebonenreservoir niet beschikbaar	Druk op een willekeurige knop om het apparaat in de stand-bymodus te zetten. Bevestig het koffiebonenreservoir goed en start het apparaat opnieuw op.	Neem contact op met de klantenservice als dit probleem zich blijft voordoen.
E3	De warmtebuis werkt niet correct	Haal de stekker uit het stopcontact. Steek de stekker in het stopcontact en schakel het apparaat weer in, totdat het weer volledig is afgekoeld.	Neem contact op met de klantenservice als dit probleem zich blijft voordoen.
E4	Maalmolen geblokkeerd	Haal de stekker uit het stopcontact. Steek de stekker in het stopcontact en schakel het apparaat weer in. Volg de stappen in 'De maalmolentrichter reinigen' om de maalmolen en de trechter voor gemalen koffie te reinigen.	Neem contact op met de klantenservice als dit probleem zich blijft voordoen.

E5	Trechter voor gemalen koffie is verstopt	Haal de stekker uit het stopcontact. Steek de stekker in het stopcontact en schakel het apparaat weer in Volg de stappen in 'De maalmolentrichter reinigen' om de trechter voor gemalen koffie te reinigen.	Neem contact op met de klantenservice als dit probleem zich blijft voordoen.
E6/E7/E8	Foutmelding programma	Haal de stekker uit het stopcontact. Steek de stekker in het stopcontact en schakel het apparaat weer in	Neem contact op met de klantenservice als dit probleem zich blijft voordoen.

Innledning

Gratulerer med kjøpet, og velkommen til Philips!

Hvis du vil dra full nytte av støtten som Philips tilbyr, kan du registrere produktet ditt på www.philips.com/welcome.

Generell beskrivelse

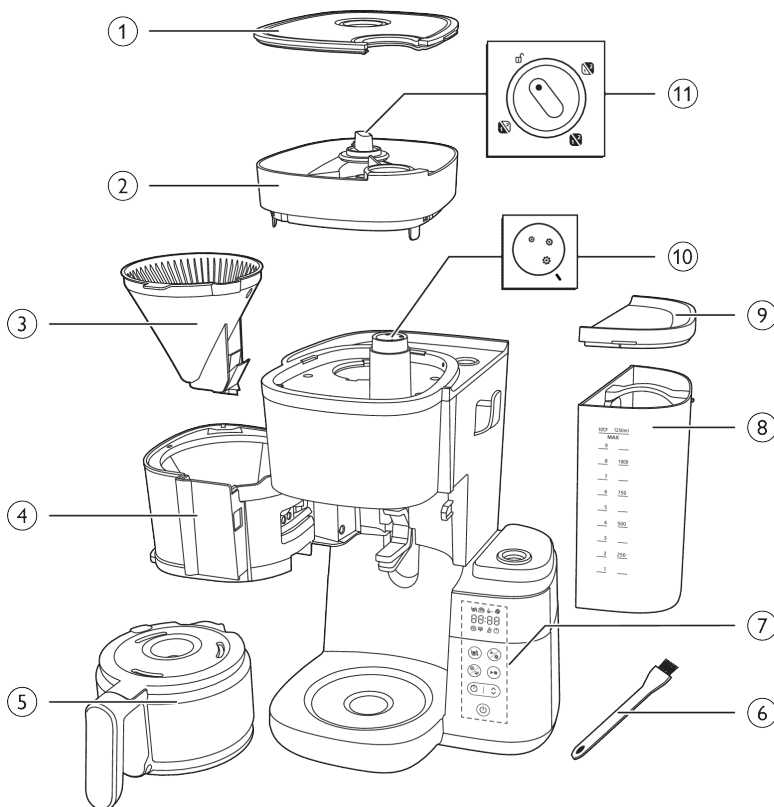

- 1 Løkk til bønnebeholder
- 2 Bønnebeholder
- 3 Filterkurv
- 4 Filterkurvholder
- 5 Glasskane
- 6 Rengjøringsbørste til bønnesjakt
- 7 Kontrollpanel med skjerm
- 8 Vannbeholder
- 9 Løkk til vannbeholder
- 10 Vriknott for grovhet
- 11 Vriknott for valg av beholder

Kontrollpanel



På/av-knapp



Timer-knapp og pilknapp for tidsjustering



Start/stopp-knapp



Rengjøringsknapp



Knapp for forhåndsmalt kaffe og kaffestyrke



Knapp for koppevalg

Ikonvisning



Antall kopper



Hold varm-modus



Forhåndsmalt kaffe



Kaffestyrke



Avkalking



Varsel om manuell rengjøring



Lavt vannnivå



Timer



Tidsvisning

De to første sifrene representerer timene, og de to siste sifrene representerer minuttene.



Vri på knotten for å låse opp, slik at du kan fjerne bønnebeholderen fra apparatet.



Ved å vri på denne knotten kan du velge grovhet: større indikerer grovere prosessering.



Kannemodus

Funksjonen med dryppstopp finnes i kannemodus.

Merk: Trakteprosessen stopper ikke når du fjerner kannen. Hvis du ikke setter kannen tilbake i apparatet innen 20 sekunder, flyter filterkurven over.



Koppmodus

Vri på knotten fra koppmodus til kannemodus for å åpne dryppstopperen og dermed hindre at det drypper når traktesyklusen er ferdig

Merk: Et kaldt keramisk krus vil trekke varme fra kaffen mens den varmer seg opp, av den grunn bør koppen forhåndsvarmes med varmt vann.

Viktig

Advarsel

- Før du kobler til apparatet, må du kontrollere at spenningen som er angitt på apparatet, stemmer overens med nettspenningen.
- Koble apparatet til en jordet veggkontakt.
- Du må ikke bruke apparatet hvis støpselet, strømledningen eller selve apparatet er ødelagt.
- Hvis ledningen er ødelagt, må den alltid skiftes ut av Philips, et servicesenter som er godkjent av Philips eller lignende kvalifisert personell for å unngå farlige situasjoner.
- Dette apparatet kan brukes av barn over 8 år og av personer med nedsatt sansevne eller fysisk eller psykisk funksjonsevne, eller personer med manglende erfaring eller kunnskap, dersom de får instruksjoner om sikker bruk av apparatet eller tilsyn som sikrer sikker bruk, og hvis de er klar over risikoen. Barn skal ikke rengjøre eller vedlikeholde apparatet med mindre de er over 8 år, og har tilsyn. Hold apparatet og strømledningen utenfor rekkevidden til barn som er under 8 år.
- Barn skal ikke leke med apparatet.
- Ikke la strømledningen henge over kanten av bordet eller benken apparatet står på.
- Dette apparatet må bare brukes til det tiltenkte formålet for å unngå farer og personskader.

Forsiktig

- Skyll alltid apparatet med rent vann før første gangs bruk.
- Ikke plasser apparatet på en varm overflate, og ikke la strømledningen komme i kontakt med varme overflater.
- Ikke plasser apparatet i et skap når det er i bruk.
- Koble fra apparatet før du rengjør det, eller hvis det oppstår problemer under traktingen.
- Rengjør alltid apparatet etter at apparatet er avkjølt.
- Under trakting og med hold varm-funksjonen er vannbeholderen, filterholderen, varmeplaten, den nedre delen av apparatet og kannen som er fylt med kaffe, varme, også etter at det har gått en stund.
- Bruk aldri en ovn eller en mikrobølgeovn for å varme opp kaffen på nytt.
- Dette apparatet er beregnet på bruk i hjemmet og lignende bruksområder, som gårder, mindre overnattingssteder, personalkjøkken i butikker, på kontorer og i andre arbeidsmiljøer, og av gjester på hoteller, moteller og andre typer bomiljøer.
- Ta alltid med apparatet til et servicesenter som er autorisert av Philips, for undersøkelse eller reparasjon. Ikke åpne apparatet eller forsøk å reparere det selv.
- Overflaten på varmeelementet, filterholderen, den nedre delen av apparatet, varmeplaten og kannen som er fylt med kaffe, er utsatt for restvarme en stund etter bruk.
- Med mindre det er angitt noe annet, er all emballasje i esken laget av resirkulert papir. Se PAP-merket på esken.

Avkalking

- Avkalk kaffemaskinen når du ser at det vises et avkalkingsvarsel på skjermen. Bruk bare hvit eddik til å avkalke, siden andre produkter kan skade apparatet.

Elektromagnetiske felt (EMF)

Dette Philips-apparatet overholder standardene for elektromagnetiske felt (EMF).

Resirkulering



Dette symbolet betyr at dette produktet ikke må kastes sammen med husholdningsavfall (2012/19/EU).

Følg nasjonale regler for egen innsamling av elektriske og elektroniske produkter. Hvis du kaster produktet på riktig måte, bidrar du til å forhindre negative konsekvenser for helse og miljø.

Med mindre det er angitt noe annet, er all emballasje i esken laget av resirkulert papir. Se PAP-merket på esken.

Garanti og støtte

Versuni tilbyr to års garanti etter at produktet er kjøpt. Denne garantien er ikke gyldig hvis en mangel skyldes feilaktig bruk eller dårlig vedlikehold. Garantien vår påvirker ikke dine lovbestemte rettigheter som forbruker. Hvis du vil ha mer

informasjon eller vil ta i bruk garantien, kan du gå til nettstedet vårt, www.philips.com/support.

Før bruk første gang

Sørg for å rengjøre filterholderen og det permanente filteret etter hver bruk.

Tørk filterholderen grundig med en tørr klut etter hver bruk. Sørg for å rengjøre den for eventuell oppsamling av kondensvann.

Stille inn klokken

- 1 Koble til apparatet.
 - Timevisningen begynner å blinke.

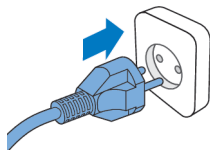

08:00



- 2 Bruk pilknappen til å stille inn timen.

08: (🔔)



- 3 Når timer er angitt, trykker du på timer-knappen for å bekrefte timer.

08:06



- 4 Minuttvisningen begynner å blinke. Bruk pilknappen til å stille inn minutter.

08:06



08:06

5 Trykk på timer-knappen for å bekrefte minuttene.

- Gjeldende klokkeslett er nå angitt og lagret.
- 6 Hvis du vil stille inn tiden i standby-modus, kan du velge mellom de to metodene nedenfor:
 - Koble fra apparatet og koble til igjen.
 - Trykk på og hold inne timer-knappen til tidsangivelsen begynner å blinke.

Merk

Apparatet lagrer alltid den siste innstillingen.

Tidsinnstilling av Hold varm-funksjon

Du kan velge hvor lenge du vil at kaffen skal holde seg varm etter traktningen, ved å stille inn hvor lang tid det skal gå før apparatet slår seg av. Standard tid for automatisk avslåing er 30 minutter. Den maksimale automatiske utkoblingstiden er 300 minutter.

Følg trinnene nedenfor for å stille inn tiden på den automatiske avslåingen:

- 1 Slå av apparatet og hold det tilkoblet.
- 2 Trykk på og hold inne rengjøringsknappen til Hold varm-ikonet vises, og antall timer begynner å blinke.
- 3 Følg trinnene i avsnittet Stille inn klokken for å fullføre innstillingen.

Skulle apparatet

Skyll alltid kaffetrakteren én gang før første gangs bruk ved å følge trinnene nedenfor.

Advarsel: Hell aldri vann i bønnebeholderen, for det vil skade kaffetrakteren.

- 1 Åpne lokket på vannbeholderen.

Forsiktig: Ikke ha kaffebønner eller forhåndsmalt kaffe i vannbeholderen

- 2 Du kan fylle vann i vannbeholderen på en av følgende måter:

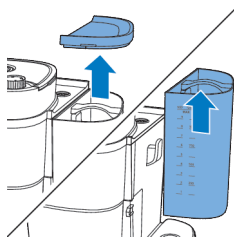

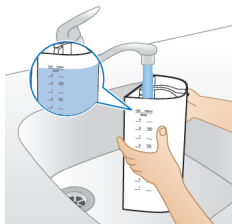

- Løft tanken fra apparatet, og plasser den under springen for å fylle på vann.

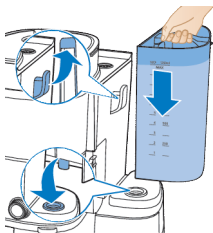

- Kontroller at kroken er ordentlig festet når du setter den tilbake.
- Ta tak i lokket for å trekke opp kannelokket. Sett kaffekannen under springen for å fylle på vann. Fyll vannbeholderen med kaffekannen.
- Kontroller at vannet er under maksimumsnivået.

3 Lukk lokket på vannbeholderen.

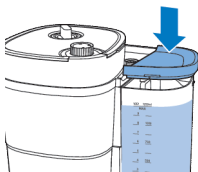

4 Sett kaffekannen tilbake i apparatet.

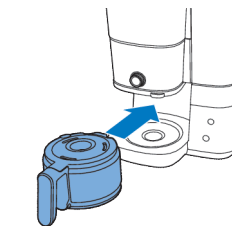

5 Vri på den midtre knotten til kaffe-innstillingen.

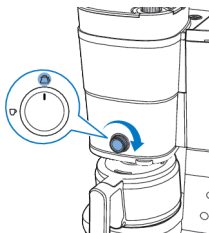



6 Trykk på på/av-knappen.

- Apparatet slås på.



7 Trykk på knappen for kaffestyrke, og velg forhåndsmalt kaffe.

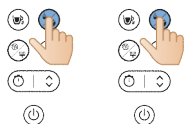

8 Trykk på koppknappen og velg 10 kopper.

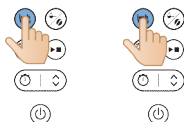

9 Trykk på start-knappen.



10 Apparatet starter skylleprosessen.

11 La apparatet gå til skylleprosessen er ferdig.

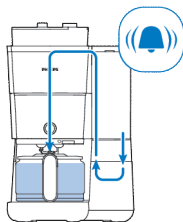



12 Tøm glasskannen.

Bruke apparatet

Bruke kaffebønner

Merk: Kaffemaskinen vil bruke nødvendig mengde vann basert på antall kaffekopper som skal tilberedes

Følg trinnene nedenfor for å bruke:

1 Åpne lokket på vannbeholderen, og løft tanken fra apparatet.

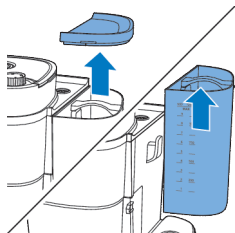

2 Fyll tanken med vann fra springen.

- Kontroller at vannivået er under maksimumsnivået.



3 Sett tanken tilbake på plass i apparatet.

- Kontroller at kroken er ordentlig festet.

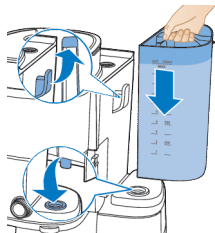

- 4 Lukk lokket på vannbeholderen.

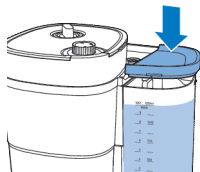

- 5 Løft lokket på bønnebeholderen.

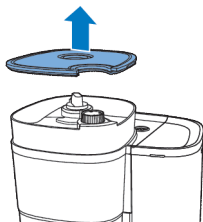

- 6 Tilsett de ønskede kaffebønnene i beholderen.

Merk: Sørg alltid for at beholderen med friske bønner er minst halvfull.

Advarsel: For å hindre at kvernen setter seg fast, må du ikke bruke ubrente eller karamelliserte bønner. Bruk kaffebønner i stedet for espressobønner, siden sistnevnte kan skade kvernen.

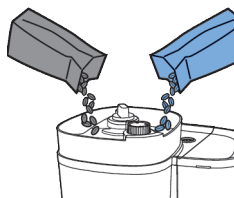

- 7 Lukk lokket på bønnebeholderen.

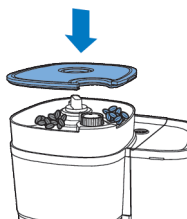

- 8 Vri på knotten for beholdervalg for å veksle mellom bønnene i de to beholderne.

- Du kan også blande sammen to ulike typer bønner for en unik blanding.

Merk: Når du veksler mellom kaffebønnebeholdere eller kaffebønner, vil det alltid finnes spor av kaffe fra tidligere malte kaffebønner. For å forhindre dette kan du rengjøre kverltrakten etter at du har byttet til en ny type kaffebønne.

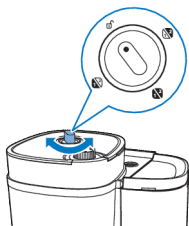

9 Velg ønsket grovhet ved å vri på knotten.

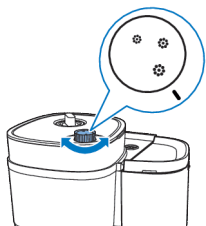

10 Ta tak i hanken for å åpne filterholderen.

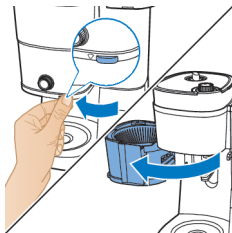

11 Legg i et papirfilter (type 1x4 eller nr. 4) i filterkurven.

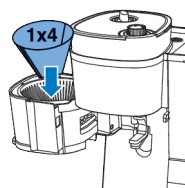

12 Lukk filterholderen

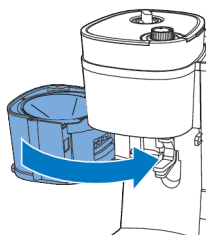

13 Plasser kaffekannen eller koppen under kaffeutgangen.

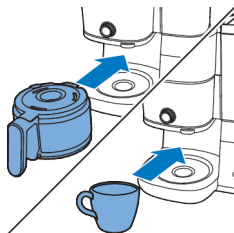

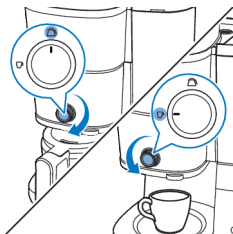

14 Vri på knotten for å velge hvor mye kaffe du skal lage.

Når du bruker brygg til kopp-funksjonen, kan du bruke kopper og glass av glass og keramikk. Sørg for at du bruker kopper som er lavere enn 10 cm.

☕ 3
10 3

15 Slå på apparatet.



16 Velg antall kopper du vil lage, ved å trykke på koppknappen.

☕ 3
1 3



17 Trykk på styrke-knappen for å velge ønsket kaffestyrke.

- 1: Bønner for mild kaffe
- 2: Bønner for middels sterk kaffe
- 3: Bønner for sterk kaffe

☕ 2
1 2



18 Start prosessen ved å trykke på start/pause-knappen.

☕ 1
1 1



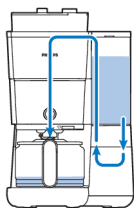

19 Apparatet setter i gang prosessen.

- Apparatet piper når det er ferdig.

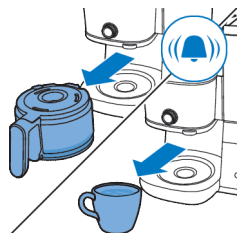

20 Ta koppen eller kaffekannen ut av apparatet.

Med dryppstoppfunksjonen kan du fjerne kannen fra kaffetrakten før trakteprosessen er ferdig. Når du fjerner kannen, vil dryppstopperen stanse kaffestrømmen til kannen.

Trakteprosessen stopper ikke når du fjerner kannen. Hvis du ikke setter kannen tilbake i apparatet innen 20 sekunder, flyter filterkurven over.



21 Nå kan du nyte nybrygget kaffe.

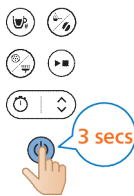

22 Hvis du vil slå av apparatet, trykker du inn start/pause-knappen i tre sekunder.

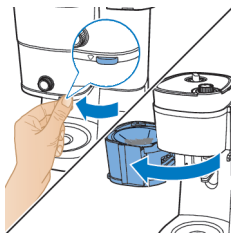

23 Åpne filterholderen.

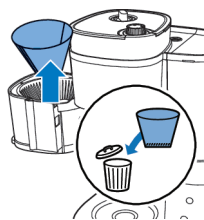

24 Fjern det brukte papirfilteret.

Hold varm-funksjonen aktivert ikke når du trakter én eller to kopper.

Apparatet holder drikken varm til den slås av automatisk. Trykk på på/av-knappen hvis du ikke lenger vil holde kaffen varm.

Bruke forhåndsmalt kaffe

Følg trinnene nedenfor for å bruke:

- 1 Kontroller at apparatet har nok vann til å lage ønsket mengde kaffe.

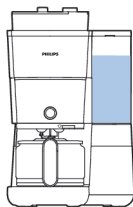

- 2 Ta tak i hanken for å åpne filterholderen.

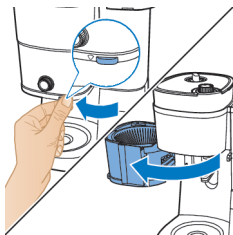

- 3 Legg i et papirfilter (type 1x4 eller nr. 4) i filterkurven.

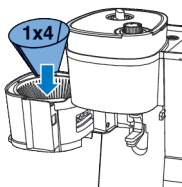

- 4 Legg til den mengden forhåndsmalt kaffe i papirfilteret som du bruker, avhengig av hva som er ønskelig.
 - Til en standard kopp kaffe kan du bruke 6 gram malt kaffe eller 1 spiseskje.

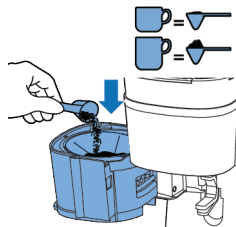

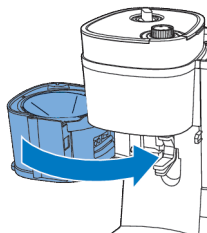

5 Lukk filterholderen.

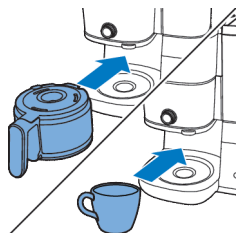

6 Plasser kaffekannen eller koppen under kaffeutgangen.

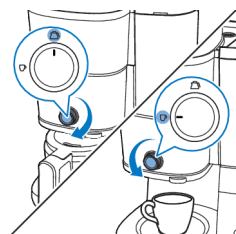

7 Vri på knotten for å velge hvor mye kaffe du skal lage.

10 3

8 Slå på apparatet.



10 3 → 10 3

9 Velg forhåndsmalt kaffe ved å trykke på knappen for modusvalg.



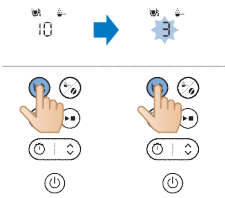

10 Velg antall kopper du vil lage, ved å trykke på koppknappen.



11 Start prosessen ved å trykke på start/pause-knappen.



12 Apparatet setter i gang prosessen.

- Apparatet piper når det er ferdig.

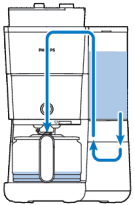

13 Ta koppen eller kaffekannen ut av apparatet.

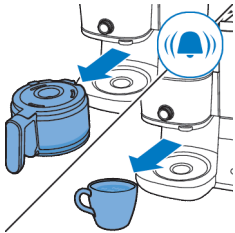

14 Nå kan du nyte nybrygget kaffe.



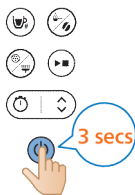

15 Hvis du vil slå av apparatet, trykker du inn start/pause-knappen i tre sekunder.

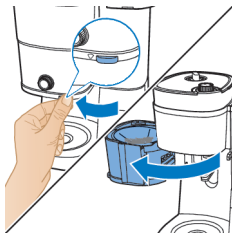

16 Åpne filterholderen.

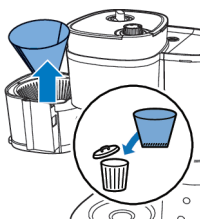

17 Fjern det brukte papirfilteret.

Stille inn timeren

Følg denne fremgangsmåten for å stille inn timeren på apparatet:

- 1** Slå på kaffemaskinen.
- 2** Trykk på timer-knappen, så vil timer-ikonet vises på skjermen. Tallet for timer blinker og viser gjeldende innstilling for timer.

08:06



08:00



08:



08:05



08:05



3 Bruk pilknappen til å stille inn timene. Hvis du trenger å justere raskt, trykker du lenge på pilknappen.

4 Trykk på timer-knappen for å lagre innstillingen for antall timer. Tallet for minutter viser gjeldende innstilling for minutter.

5 Bruk pilknappen igjen for å stille inn antall minutter. Hvis du trenger å justere raskt, trykker du lenge på pilknappen.

6 Trykk på timer-knappen igjen for å lagre innstillingen for antall minutter.

For å avbryte timeren, trykker du bare på timer-knappen, og timer-ikonet forsvinner fra skjermen.

Med dryppstoppfunksjonen kan du fjerne kannen fra kaffetrakteren før trakteprosessen er ferdig. Når du fjerner kannen, vil dryppstopperen stanse kaffestrømmen til kannen.

Merk: Trakteprosessen stopper ikke når du fjerner kannen. Hvis du ikke setter kannen tilbake i apparatet innen 20 sekunder, flyter filterkurven over.

Rengjøring og vedlikehold

Rengjøring etter hver bruk

Kaffemaskinen må aldri senkes ned i vann eller annen væske, og den må heller ikke skylles under rennende vann.

- 1 Ta ut støpselet fra veggkontakten.

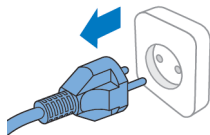









- 2 Tørk av utsiden av kaffemaskinen med en fuktig klut.
3 Rengjør filterkurven med varmt vann og litt oppvaskmiddel, eller rengjør den i oppvaskmaskinen.



- 4 Rengjør kaffekannen og lokket ved å skylle under springen, eller sett dem i oppvaskmaskinen.

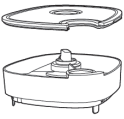

			
	✓	✓	✓
	✓	✓	✓
	✓	✓	✓
	✓	✗	✓
	✓	✗	✓

Rengjøre kverltrakten

Viktig:

Rengjør kverltrakten etter én til to uker for å unngå tilstopping av malt kaffe. Dette gjøres enkelt og raskt ved å følge trinnene nedenfor.

Rengjør kverltrakten når du legger merke til at det vises et børstevarsel på skjermen.

Merk: Kontroller at beholderen for kaffebønner er tom før du starter rengjøringsprosessen.

- 1 Koble til apparatet.

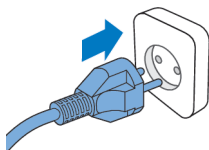

- 2 Åpne filterholderen for å få tilgang til kvernsjakten.

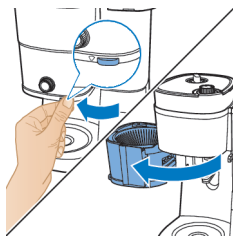

- 3 Slå på kaffemaskinen.

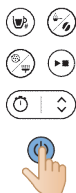

- 4 Trykk på rengjøringsknappen på maskinens kontrollpanel.
- 5 Velg børsteinnstillingen på skjermen.





- 6 Trykk på start-knappen. Dette vil føre til at klaffen på kvernsjakten åpnes, slik at du kan rengjøre trakten med en børste.

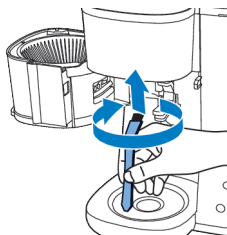

- 7 Bruk en børste til å fjerne kaffegrut eller rester som kan ha samlet seg i trakten.

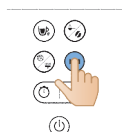

- 8 Når du har rengjort sjakten, trykker du på startknappen igjen for å lukke klaffen.

Avkalking av kaffemaskinen

Avkalk kaffemaskinen når du ser at det vises et avkalkingsvarsel på skjermen. Bruk bare hvit eddik til å avkalke, siden andre produkter kan skade kaffemaskinen.

Advarsel: Bruk aldri eddik med et eddiksyreinnhold på 8 % eller mer, naturlig eddik, avkalkingsmiddel i pulver eller pastiller, siden dette kan føre til skader.

1 Åpne lokket på vannbeholderen.

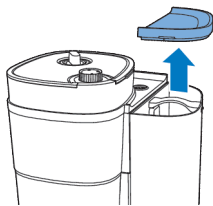

2 Fyll vannbeholderen med hvit eddik (4 % eddiksyre) opp til merket for 10 kopper.

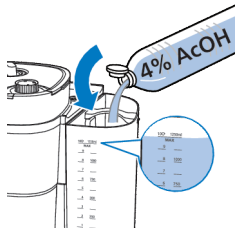

3 Lukk lokket på vannbeholderen.

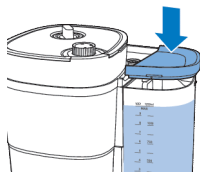

4 Ta tak i hanken for å åpne filterholderen.

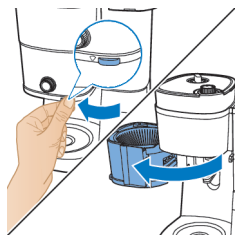

5 Legg i et papirfilter (type 1x4 eller nr. 4) i filterkurven og lukk filterkurvholderen.

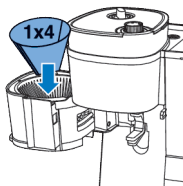

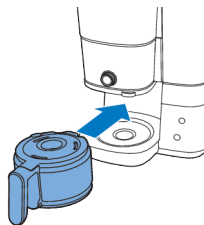

6 Sett den tomme kannen i kaffemaskinen.

7 Sett i støpselet i en jordet veggkontakt.

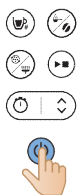

8 Trykk på på/av-knappen for å slå på kaffemaskinen. Skjermen slås på.

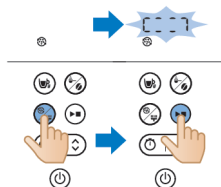

9 Trykk på rengjøringsknappen på kaffemaskinen.

10 Velg avkalkingsinnstillingen.

11 Trykk inn startknappen for å bekrefte valget.

- Kaffemaskinen starter avkalkingsprosessen automatisk.

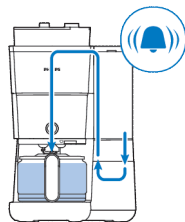

12 Vent til maskinen er ferdig med å trakte avkalkingsblandingen.

13 Etter at avkalkingsprosessen er fullført, må du skylle maskinen to ganger med den maksimale mengden vann for å fjerne alle avleiringer.

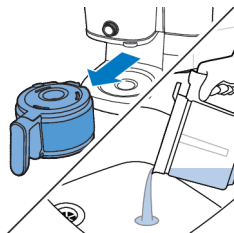

14 Tøm kannen, og fjern papirfilteret med kalkrester.

15 Fyll vannbeholderen med friskt kaldt vann, og trykk på startknappen for å starte en ny trakteprosess.

La kaffemaskinen fullføre hele trakteprosessen og tøm deretter kannen.

Merk: Gjenta om nødvendig trinn 14 til vannet som kommer ut av kaffemaskinen, ikke lenger smaker eller lukter eddik.

16 Rengjør filterkurven og kannen med varmt vann og litt oppvaskmiddel.

17 Trykk på på/av-knappen for å slå av apparatet.

Feilsøking

Dette kapittelet oppsummerer de vanligste problemene du kan oppleve med maskinen. Hvis du ikke kan løse problemet ved hjelp av informasjonen nedenfor, kan du gå til www.philips.com/support for å se en liste over vanlige spørsmål, eller du kan kontakte forbrukerstøtten i landet der du bor.

Du kan også skanne denne QR-koden for å få mer hjelp online.



Problem	Løsning
Kaffemaskinen virker ikke.	Sett støpselet inn i en jordet veggkontakt, og trykk på på/av-knappen for å slå på kaffemaskinen.
	Kontroller at spenningen som er angitt på kaffemaskinen, stemmer overens med den lokale nettspenningen.
	Fyll vannbeholderen med vann.
	Lukk lokket på kverltrakten.
Kvernen virker ikke eller virker ikke som den skal.	Kontroller at du ikke valgte forhåndsmalt kaffe. Hvis symbolet for forhåndsmalt kaffe vises på skjermen, valgte du forhåndsmalt kaffe.
	Rengjør kverltrakten ved å følge instruksjonene.
Når jeg bruker kvernen, er kaffen for svak.	Vri på grovhetsknoten for å velge ønsket oppmaling, fra fin til grov.
	Bruk knappen for styrkevalg til å angi kaffestyrken fra 1 til 3, der et høyere tall betyr sterkere kaffe.
	Bruk kaffebønner av en sterkere blanding eller smak.
Når jeg bruker forhåndsmalt kaffe, er kaffen for svak.	Kontroller at mengden forhåndsmalt kaffe i filteret stemmer overens med mengden vann i vannbeholderen. Husk at kaffemaskinen bruker opp alt vannet i vannbeholderen.
	Bruk malt kaffe av en sterkere blanding eller smak.
	Hvis du vil øke kaffestyrken, øker du mengden forhåndsmalt kaffe eller reduserer vannmengden.
Filteret flyter over når jeg fjerner kannen fra kaffemaskinen mens det trakter kaffe.	Hvis du fjerner kannen i mer enn 20 sekunder under trakteprosessen, gjør dryppstopperen at filterkurven flyter over. Legg også merke til at kaffen ikke oppnår full smak før bryggeprosessen er ferdig. Derfor anbefaler vi at du ikke fjerner kannen og heller ut kaffe før trakteprosessen er ferdig.
Kaffemaskinen fortsetter å dryppe lenge etter at trakteprosessen er avsluttet.	Dryppingen skyldes kondens av damp. Det er helt normalt at kaffemaskinen drypper en stund.

Jeg vil ikke vente på de siste kaffedråpene.	Vri knotten fra kopp til kanne for å åpne dryppstoppfunksjonen. Dryppstopperen stopper drypping fra filterkurven.
	Hvis dryppingen ikke stopper, kan dryppstopperen være tett. Hvis du vil rengjøre dryppstopperen, åpner du filterkurvholderen og tar ut filterkurven. Skyll filterkurven og dryppstopperen under springen.
Kaffen er ikke varm nok.	Kaffen i kannen avkjøles raskere hvis du trakter bare noen få kopper. Kaffen holder seg varm lenger hvis du trakter 10 kopper, som er en full kanne.
	Avkalk kaffemaskinen.
Kaffebønnene brukes opp raskt.	Hvis du vil trakte en perfekt kopp kaffe, trenger kaffemaskinen en viss mengde malt kaffe. Mengden kaffebønner som kaffemaskinen bruker for å oppnå optimal mengde malt kaffe per kopp, er normal.
Timeren virker ikke.	Kontroller at du har fullført alle trinnene for traktning av kaffe med kaffebønner eller forhåndsmalt kaffe før du stiller inn timeren.

Feilkode

Feilkode	Beskrivelse	Løsning	Merknad
E1	Vannmangel	Trykk på en hvilken som helst knapp for å sette apparatet i standby-modus. Fyll på vannbeholderen, og start apparatet på nytt.	Hvis dette problemet vedvarer, følger du disse trinnene: Trykk på og hold inne rengjørings- og startknappen samtidig i tre sekunder til apparatet automatisk begynner å pumpe vann i ett minutt. Gjenta denne prosessen tre ganger. Kontakt kundeservice hvis problemet vedvarer.
E2	Bønnebeholderen er utilgjengelig	Trykk på en hvilken som helst knapp for å sette apparatet i standby-modus. Fest bønnebeholderen på en sikker måte, og start apparatet på nytt	Kontakt kundeservice hvis problemet vedvarer.
E3	Funksjonsfeil på varmerøret	Koble fra apparatet. Koble til og slå på apparatet igjen til det er helt avkjølt.	Kontakt kundeservice hvis problemet vedvarer.
E4	Blokkering av kvernhjulet	Koble fra apparatet. Koble til og slå på apparatet igjen. Følg trinnene i «Rengjøre kvernrakten» for å rengjøre kvernhjulet og kvernsjakten.	Kontakt kundeservice hvis problemet vedvarer.

E5	Blokkering av kvernsjakt	Koble fra apparatet. Koble til og slå på apparatet igjen. Følg trinnene i «Rengjøre kverntrakten» for å rengjøre kvernsjakten.	Kontakt kundeservice hvis problemet vedvarer.
E6/E7/E8	Programfeil	Koble fra apparatet. Koble til og slå på apparatet igjen.	Kontakt kundeservice hvis problemet vedvarer.

Wstęp

Gratulujemy zakupu i witamy w firmie Philips!

Aby w pełni skorzystać z obsługi świadczonej przez firmę Philips, należy zarejestrować zakupiony produkt na stronie www.philips.com/welcome.

Opis ogólny

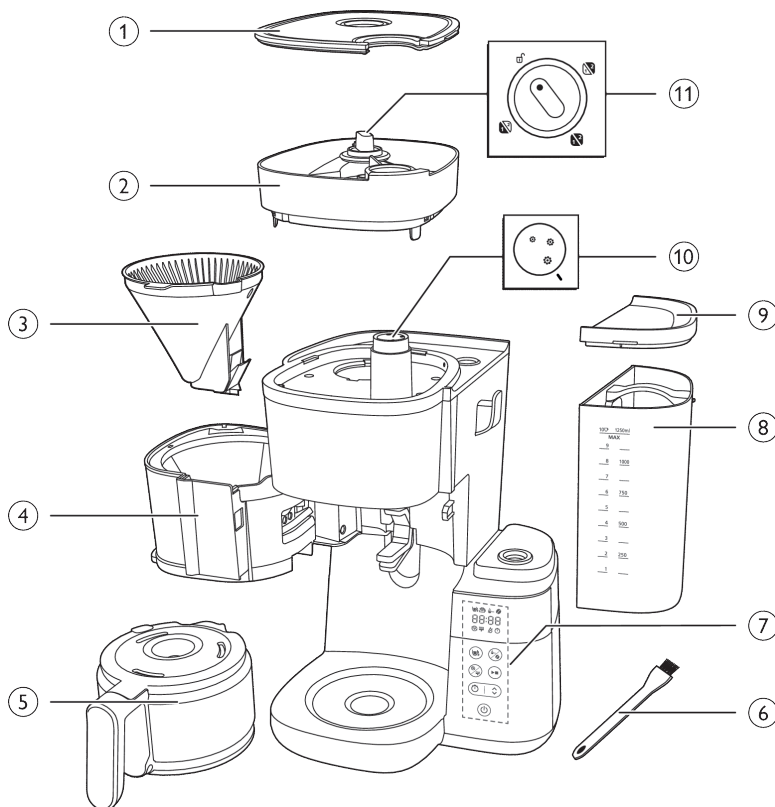

- 1 Pokrywka zbiornika na ziarna
- 2 Zbiornik na ziarna
- 3 Koszyk filtra
- 4 Uchwyt koszyka filtra
- 5 Szklany dzbanek
- 6 Szczoteczka do czyszczenia zsyu ziaren kawy
- 7 Panel sterowania z wyświetlaczem
- 8 Zbiornik wody
- 9 Pokrywka zbiornika wody
- 10 Pokrętko regulacji grubości
- 11 Pokrętko wyboru zbiornika

Panel sterowania



Przycisk zasilania



Przycisk zegara i przycisk strzałki do ustawiania czasu



Przycisk uruchomienia/wstrzymania



Przycisk czyszczenia



Przycisk wstępnego mielenia i mocy kawy



Przycisk wyboru filiżanki

Wyświetlana ikona



Liczba filiżanek



Tryb utrzymywania ciepła



Kawa mielona



Moc kawy



Usuwanie kamienia



Alarm czyszczenia ręcznego



Wskazanie niskiego poziomu wody



Zegar



Wyświetlacz czasu

Dwie pierwsze cyfry oznaczają godziny, a dwie ostatnie cyfry oznaczają minuty.



Obróć pokrętkę do pozycji odblokowanej, aby wyjąć zbiornik na ziarna z urządzenia.



Tym pokrętkiem wybiera się grubość kawy — większy rozmiar oznacza grubsze ziarna.



Tryb dzbanka

W trybie dzbanka jest funkcja blokady kapania.

Uwaga: proces parzenia nie zostanie przerwany po wyjęciu dzbanka. Jeśli nie umieścisz dzbanka ponownie w urządzeniu w ciągu 20 sekund, koszyk filtra się przeleje.



Tryb filiżanki

Przekręć ręcznie pokrętkę z trybu filiżanki do trybu dzbanka, aby otworzyć blokadę kapania i zapobiec kapaniu po zakończeniu cyklu parzenia

Uwaga: zimny kubek ceramiczny będzie zabierał kawie ciepło i sam się podgrzewał, podgrzej najpierw kubek gorącą wodą.

Ważne

Ostrzeżenie

- Przed podłączeniem urządzenia upewnij się, że napięcie podane na urządzeniu jest zgodne z napięciem w sieci elektrycznej.
- Podłączaj urządzenie do uziemionego gniazdka elektrycznego.
- Nie używaj urządzenia, jeśli uszkodzona jest wtyczka, przewód sieciowy lub samo urządzenie.
- Ze względów bezpieczeństwa wymianę uszkodzonego przewodu sieciowego zleć autoryzowanemu centrum serwisowemu firmy Philips lub odpowiednio wykwalifikowanej osobie.
- Urządzenie może być używane przez dzieci w wieku powyżej 8 lat oraz osoby z ograniczonymi zdolnościami fizycznymi, sensorycznymi lub umysłowymi, a także nieposiadające wiedzy lub doświadczenia w zakresie użytkowania tego typu urządzeń, pod warunkiem, że będą one nadzorowane lub zostaną poinstruowane na temat korzystania z tego urządzenia w bezpieczny sposób oraz zostaną poinformowane o potencjalnych zagrożeniach. Urządzenie nie może być czyszczone ani obsługiwane przez dzieci poniżej 8 roku życia. Starsze dzieci podczas wykonywania tych czynności powinny być nadzorowane przez osoby dorosłe. Przechowuj urządzenie oraz przewód sieciowy poza zasięgiem dzieci poniżej 8 roku życia.
- Dzieci nie mogą bawić się urządzeniem.
- Nie pozwól, aby przewód sieciowy zwisał z krawędzi stołu lub blatu, na którym ustawione jest urządzenie.

- Tego urządzenia należy używać zgodnie z przeznaczeniem, aby uniknąć obrażeń ciała

Ostrzeżenie

- Zawsze spłucz urządzenie czystą wodą przed pierwszym użyciem.
- Nie stawiaj urządzenia na gorącej powierzchni i nie dopuszczaj do kontaktu przewodu zasilającego z gorącymi powierzchniami.
- Nie stawiaj urządzenia w szafce w trakcie użytkowania.
- Wyjmij wtyczkę urządzenia z gniazdka elektrycznego przed wyczyszczeniem i w razie problemów podczas parzenia.
- Urządzenie należy czyścić dopiero po jego wystygnięciu.
- Zbiornik wody, płyta grzejna, dolna część urządzenia i dzbanek z kawą są gorące nawet jakiś czas po parzeniu i utrzymywaniu ciepła.
- Nie stawiaj dzbanka na kuchence ani nie wstawiaj do kuchenki mikrofalowej w celu podgrzania kawy.
- To urządzenie jest przeznaczone do użytku w domach i podobnych miejscach, takich jak domy wiejskie, pensjonaty, kuchnie dla pracowników w sklepach, biurach i innych miejscach pracy, oraz do użytku przez klientów hoteli, moteli itp.
- Konieczność przeglądu lub naprawy urządzenia zawsze zgłaszaj do autoryzowanego centrum serwisowego firmy Philips. Nie próbuj samodzielnie otwierać ani naprawiać urządzenia.
- Powierzchnia elementu grzejjego, uchwyt filtra, dolna część urządzenia, płyta grzejna i dzbanek z kawą mogą pozostawać gorące przez jakiś czas po użyciu.
- O ile nie wskazano inaczej, wszystkie materiały opakowaniowe w opakowaniu są wykonane z papieru z recyklingu; patrz oznaczenie PAP na opakowaniu.

Usuwanie kamienia

- Należy usunąć kamień z ekspresu do kawy, jeśli na wyświetlaczu pojawi się alarm informujący o konieczności usunięcia kamienia. Do usuwania kamienia należy używać tylko białego octu, ponieważ inne produkty mogą uszkodzić urządzenie.

Pola elektromagnetyczne (EMF)

Niniejsze urządzenie Philips spełnia normy dotyczące pól elektromagnetycznych.

Recykling



Ten symbol oznacza, że produktu nie można zutylizować z pozostałymi odpadami domowymi (2012/19/UE).

Należy postępować zgodnie z obowiązującymi w danym kraju przepisami dotyczącymi selektywnej zbiórki urządzeń elektrycznych i elektronicznych. Prawidłowa utylizacja pomaga chronić środowisko naturalne oraz ludzkie zdrowie.

O ile nie wskazano inaczej, wszystkie materiały opakowaniowe w opakowaniu są wykonane z papieru z recyklingu; patrz oznaczenie PAP na opakowaniu.

Gwarancja i pomoc techniczna

Firma Versuni oferuje dwuletnią gwarancję od daty zakupu tego produktu. Niniejsza gwarancja nie jest ważna, jeśli usterka jest spowodowana nieprawidłowym użytkowaniem lub niewłaściwą konserwacją. Nasza gwarancja nie wpływa na prawa użytkownika wynikające z prawa konsumenta. Aby uzyskać więcej informacji lub skorzystać z gwarancji, odwiedź naszą stronę internetową www.philips.com/support.

Przed pierwszym użyciem

Wyczyść uchwyt filtra i filtr stały po każdym użyciu.

Dokładnie wytrzyj uchwyt filtra suchą szmatką po każdym użyciu. Zetrzyj nagromadzony osad.

Ustawianie zegara

- 1 Włóż wtyczkę urządzenia do gniazdka elektrycznego.
 - Wyświetlacz z godziną zacznie migać.

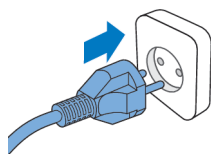

08:00



- 2 Użyj przycisku strzałki, aby ustawić godzinę.

08:00



- 3 Po ustawieniu godziny naciśnij przycisk zegara, aby ją zatwierdzić.



08:06



08:06



08:06

4 Pozycja minut zacznie migać. Użyj przycisku strzałki, aby ustawić minuty.

5 Naciśnij przycisk zegara, aby zatwierdzić minuty.

- Aktualna godzina została ustawiona i zapisana.

6 Aby ustawić zegar w trybie gotowości, można wybrać jedną z dwóch poniższych metod:

- Odłącz urządzenie od prądu i podłącz ponownie.

- Naciśnij i przytrzymaj przycisk zegara, aż zaczną migać cyfry godziny.

Uwaga

Urządzenie zawsze zapisuje ostatnie ustawienie.

Czas utrzymywania ciepła

Możesz zdecydować, jak długo kawa ma być gorąca po zaparzeniu, ustawiając czas, po którym urządzenie wyłączy się automatycznie. Domyślnie automatyczne wyłączenie nastąpi po 30 minutach. Maksymalny czas automatycznego wyłączenia to 300 minut.

Aby ustawić czas automatycznego wyłączenia, postępuj zgodnie z poniższymi instrukcjami:

- 1 Wyłącz urządzenie, ale nie wyjmuj wtyczki z gniazdka elektrycznego.
- 2 Naciśnij i przytrzymaj przycisk czyszczenia, aż pojawi się ikona utrzymywania ciepła i zacznie migać godzina.
- 3 Postępuj zgodnie z instrukcjami ustawiania zegara, aby zakończyć ustawianie.

Płukanie urządzenia

Zawsze wypłucz ekspres do kawy przed pierwszym użyciem, postępując zgodnie z poniższymi instrukcjami.

Ostrzeżenie: nigdy nie wlewaj wody do zbiornika na ziarna kawy, ponieważ może to uszkodzić ekspres.

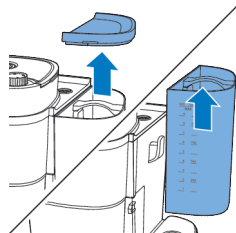

1 Otwórz pokrywkę zbiornika wody.

Uwaga: nie wsypuj ziaren kawy ani mielonej kawy do zbiornika wody

2 Można napełnić zbiornik wodą na dwa sposoby:

- Wyjmij zbiornik z urządzenia i umieść pod kranem z bieżącą wodą.



- Należy dobrze zamocować zbiornik po ponownym włożeniu do urządzenia.
- Chwyć zacisk pokrywki, aby ściągnąć pokrywkę dzbanka. Umieść dzbanek na kawę pod kranem z bieżącą wodą. Napełnij zbiornik wodą z dzbanka.
- Woda musi być poniżej maksymalnego poziomu.

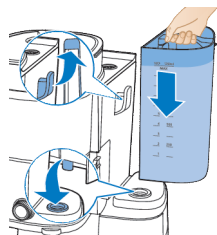

3 Zamknij pokrywkę zbiornika wody.

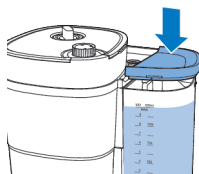

4 Umieść dzbanek na kawę w urządzeniu.

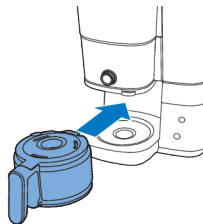

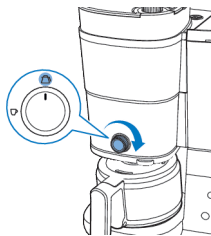

5 Przekręć środkowe pokrętło na ustawienie dzbanka.

10 3

6 Naciśnij wyłącznik.
- Urządzenie jest włączone.



7 Naciśnij przycisk mocy kawy i wybierz zmieloną kawę.

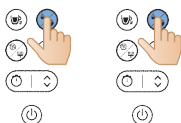

8 Naciśnij przycisk filiżanki i wybierz 10 filiżanek.

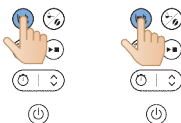

9 Naciśnij przycisk uruchomienia.



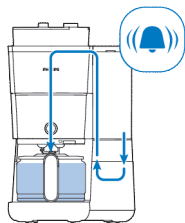

10 Urządzenie rozpocznie proces płukania.

11 Pozostaw urządzenie włączone do czasu zakończenia procesu płukania.



12 Opróżnij szklany dzbanek.

Zasady używania urządzenia

Używanie ziaren kawy

Uwaga: ekspres do kawy zużyje wymaganą ilość wody w oparciu o liczbę filiżanek kawy, które ma przygotować

Wykonaj poniższe czynności:

1 Otwórz pokrywkę zbiornika wody i wyjmij zbiornik z urządzenia.

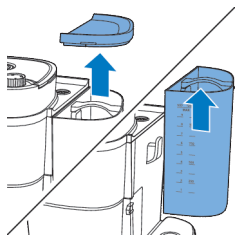

2 Napełnij zbiornik wodą z kranu.

- Nie nalewaj wody powyżej poziomu maksymalnego.



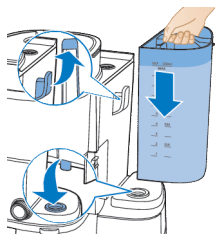

- 3 Włóż zbiornik z powrotem do urządzenia.
- Upewnij się, że zbiornik jest prawidłowo zamocowany.

- 4 Zamknij pokrywkę zbiornika wody.

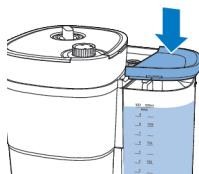

- 5 Zdejmij pokrywkę zbiornika na ziarna.

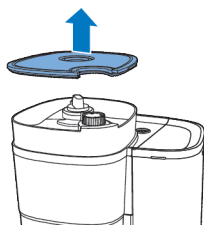

- 6 Wsyp ziarna kawy do zbiornika.

Uwaga: podwójny zbiornik na ziarna świeżej kawy musi być zapełniony co najmniej do połowy.

Ostrzeżenie: aby zapobiec blokowaniu się młynka, nie używaj ziaren kawy niepalonej lub karmelizowanej. Używaj ziaren kawy zamiast espresso, ponieważ ziarna do espresso mogą uszkodzić młynek.

- 7 Zamknij pokrywkę zbiornika na ziarna.

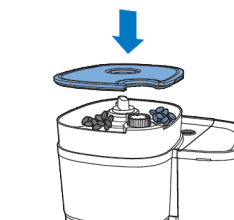

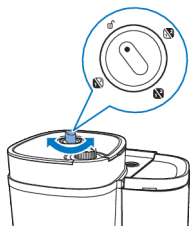

- 8** Obróć pokrętko wyboru zbiornika, aby wybrać ziarna kawy.
- Można też wymieszać różne rodzaje ziaren, aby uzyskać unikatową mieszankę.

Uwaga: po każdej zmianie zbiornika lub ziaren kawy zawsze pozostaną resztki poprzednich zmielonych ziaren. Wyczyść lejek młynka po przełączeniu na nowy typ ziaren, aby temu zapobiec.

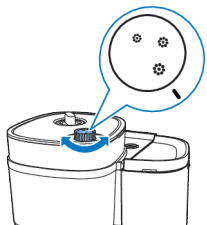

- 9** Wybierz pożądaną poziom grubości za pomocą pokrętki.

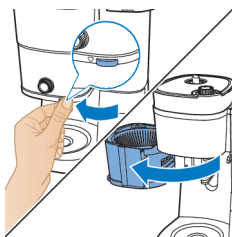

- 10** Chwyć zacisk, aby otworzyć uchwyt filtra.

- 11** Włóż papierowy filtr (typ 1x4 lub nr 4) do koszyka filtra.

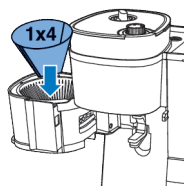

- 12** Zamknij uchwyt filtra

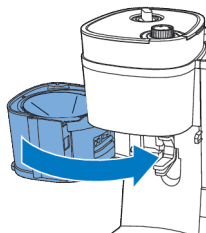

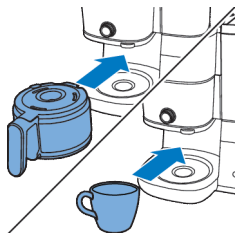

13 Wstaw dzbanek lub filiżankę pod dozownik.

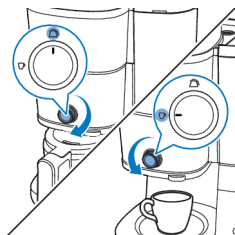

14 Za pomocą pokrętlel wybierz pożądaną ilość kawy.

Podczas stosowania funkcji zaparzania do filiżanki można użyć szklanych lub ceramicznych kubków albo szklanek. Filiżanka musi mieć poniżej 10 cm wysokości.

W 3



15 Włącz urządzenie.

W 3



16 Wybierz liczbę filiżanek, naciskając przycisk filiżanki.

W 2



17 Naciśnij przycisk mocy, aby wybrać preferowaną moc kawy.

- 1: Ziarna na kawę o niskiej mocy
- 2: Ziarna na kawę o średniej mocy
- 3: Ziarna na mocną kawę

18 Rozpocznij proces, naciskając przycisk uruchomienia/wstrzymania.



19 Urządzenie rozpocznie pracę.

- Po zakończeniu usłyszysz sygnał dźwiękowy.

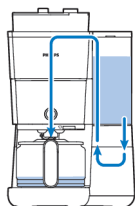

20 Wyjmij filiżankę lub dzbanek z urządzenia.

Funkcja blokady kapania umożliwia wyjęcie dzbanka z ekspresu przed zakończeniem procesu parzenia. Po wyjęciu dzbanka blokada kapania zatrzymuje strumień kawy.

proces parzenia nie zostanie przerwany po wyjęciu dzbanka. Jeśli nie umieścisz dzbanka ponownie w urządzeniu w ciągu 20 sekund, koszyk filtra się przeleje.

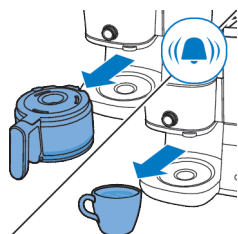

21 Rozkoszuj się świeżo zaparzoną kawą.



22 Aby wyłączyć urządzenie, naciśnij i przytrzymaj przycisk uruchomienia/wstrzymania przez 3 sekundy.

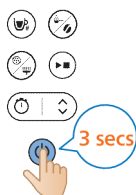

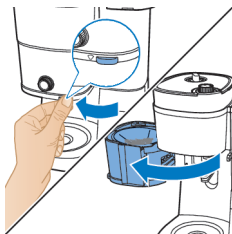

23 Otwórz uchwyt filtra.

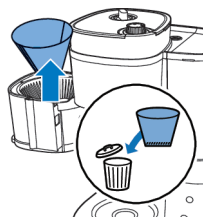

24 Wyjmij zużyty filtr papierowy.

Przy parzeniu jednej lub dwóch filiżanek funkcja utrzymywania ciepła nie włącza się.

Urządzenie będzie utrzymywało ciepło Twojego napoju do momentu automatycznego wyłączenia. Jeśli napój nie musi być już podgrzewany, naciśnij wyłącznik, aby wyłączyć urządzenie.

Używanie kawy mielonej

Wykonaj poniższe czynności:

1 Sprawdź, czy urządzenie ma wystarczającą ilość wody do przygotowania pożądanej ilości kawy.



2 Chwyć zacisk, aby otworzyć uchwyt filtra.

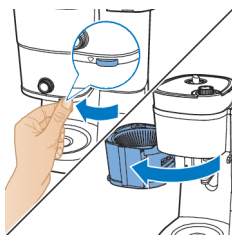

3 Włóż filtr papierowy (typ 1x4 lub nr 4) do koszyka filtra.

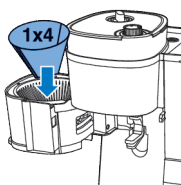

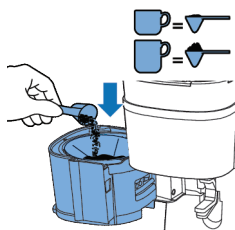

- 4 Wsyp do filtra papierowego pożądaną ilość kawy mielonej w zależności od osobistych preferencji.
- Na standardową filiżankę kawy użyj 6 gramów lub 1 łyżkę kawy mielonej.

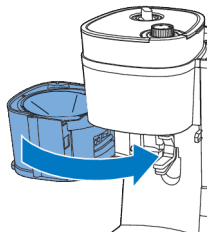

- 5 Zamknij uchwyt filtra.

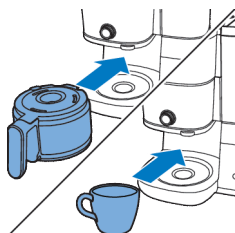

- 6 Wstaw dzbanek lub filiżankę pod dozownik.

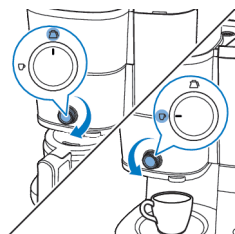

- 7 Za pomocą pokrętki wybierz pożądaną ilość kawy.

WS 3

- 8 Włącz urządzenie.





9 Wybierz opcję kawy mielonej, naciskając przycisk wyboru trybu.

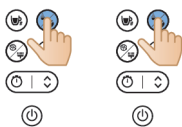

10 Wybierz liczbę filiżanek, naciskając przycisk filiżanki.

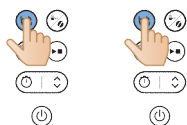

11 Rozpocznij proces, naciskając przycisk uruchomienia/wstrzymania.



12 Urządzenie rozpocznie pracę.

- Po zakończeniu usłyszysz sygnał dźwiękowy.

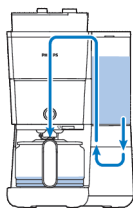

13 Wyjmij filiżankę lub dzbanek z urządzenia.

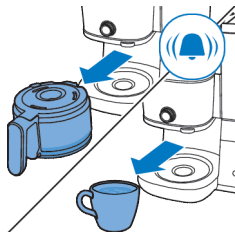



14 Rozkoszuj się świeżo zaparzoną kawą.

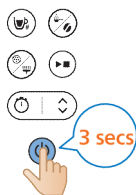

15 Aby wyłączyć urządzenie, naciśnij i przytrzymaj przycisk uruchomienia/wstrzymania przez 3 sekundy.

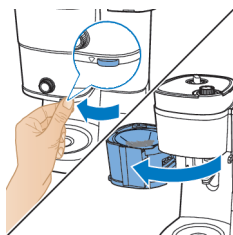

16 Otwórz uchwyt filtra.

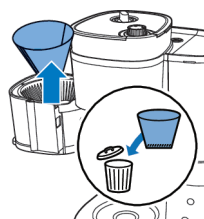

17 Wyjmij zużyty filtr papierowy.

Ustawianie zegara

Aby ustawić zegar urządzenia, postępuj zgodnie z poniższymi instrukcjami:

1 Włącz ekspres do kawy.

08:05



- 2 Naciśnij przycisk zegara, na wyświetlaczu pojawi się ikona zegara. Cyfry godziny zaczną migać, wskazując ustawianie godziny.



08:00

- 3 Ustaw godzinę za pomocą przycisku strzałki. Jeśli musisz dokonać szybkiego ustawienia, naciśnij i przytrzymaj przycisk strzałki.



08:



- 4 Naciśnij przycisk zegara, aby zatwierdzić nowe ustawienie. Cyfry minut wskazują ustawianie minut.



08:05

- 5 Ustaw minuty za pomocą przycisku strzałki. Jeśli musisz dokonać szybkiego ustawienia, naciśnij i przytrzymaj przycisk strzałki.

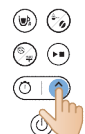

08:05



- 6 Naciśnij ponownie przycisk zegara, aby zatwierdzić ustawienie minut.
Aby anulować zegar, wystarczy nacisnąć przycisk zegara, a ikona zegara zniknie z wyświetlacza.

Funkcja blokady kapania umożliwia wyjęcie dzbanka z ekspresu przed zakończeniem procesu parzenia. Po wyjęciu dzbanka blokada kapania zatrzymuje strumień kawy.



Uwaga: proces parzenia nie zostanie przerwany po wyjęciu dzbanka. Jeśli nie umieścisz dzbanka ponownie w urządzeniu w ciągu 20 sekund, koszyczek filtra się przeleje.

Czyszczenie i konserwacja

Czyszczenie po każdym użyciu

Nigdy nie zanurzaj ekspresu do kawy w wodzie ani innym płynie. Nie opłukuj go pod bieżącą wodą.

- 1 Wyjmij wtyczkę przewodu sieciowego z gniazdka elektrycznego.

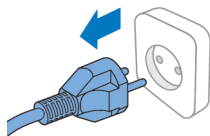







- 2 Przetrzyj zewnętrzną część ekspresu wilgotną szmatką.
- 3 Wyczyść koszyk filtra gorącą wodą i płynem do mycia naczyń lub umyj w zmywarce.



- 4 Umyj dzbanek na kawę i pokrywkę, przepłucz pod kranem. Możesz też umyć je w zmywarce.

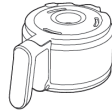
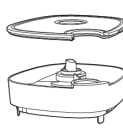

			
	✓	✓	✓
	✓	✓	✓
	✓	✓	✓
	✓	✗	✓
	✓	✗	✓

Czyszczenie lejka młynka

Uwaga:

czyść lejek młynka co 1–2 tygodnie, aby nie dopuścić do zapchania go mieloną kawą. Można to łatwo zrobić, wykonując poniższe czynności.

Wyczyść lejek młynka, gdy zauważysz alarm w postaci szczoteczki na wyświetlaczu.

Uwaga: sprawdź, czy zbiornik na ziarna kawy jest pusty, zanim zaczniesz procedurę czyszczenia.

- 1 Włóż wtyczkę urządzenia do gniazdka elektrycznego.

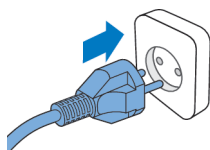

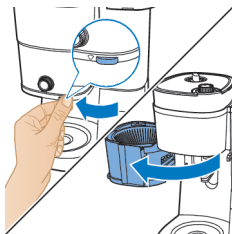

2 Otwórz uchwyt filtra, aby uzyskać dostęp do zsyłu lejka.

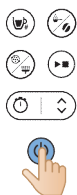

3 Włącz ekspres do kawy.

4 Naciśnij przycisk czyszczenia na panelu sterowania urządzenia.

5 Wybierz ustawienie szczoteczki na ekranie wyświetlacza.



6 Naciśnij przycisk uruchomienia. Spowoduje to otwarcie klapki zsyłu lejka, aby można było wyczyścić zsył szczoteczką.

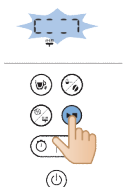

7 Za pomocą szczoteczki usuń ziarna kawy i resztki zebrane w zsyple.

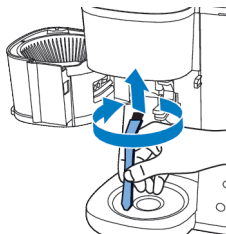



- 8 Po wyczyszczeniu zsypu naciśnij ponownie przycisk uruchomienia, aby zamknąć klapkę.

Usuwanie kamienia z ekspresu

Należy usunąć kamień z ekspresu do kawy, jeśli na wyświetlaczu pojawi się alarm informujący o konieczności usunięcia kamienia. Do usuwania kamienia używaj tylko białego octu, ponieważ inne produkty mogą spowodować uszkodzenie ekspresu.

Ostrzeżenie: nigdy nie używaj octu o stężeniu kwasu octowego na poziomie 8% lub więcej, naturalnego octu, odkamieniaczy w proszku lub w tabletkach, ponieważ może to spowodować uszkodzenie.

- 1 Otwórz pokrywkę zbiornika wody.

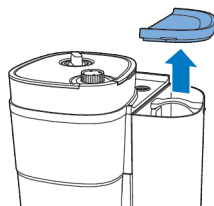

- 2 Napełnij zbiornik wody białym octem (4-procentowym roztworem kwasu octowego) do oznaczenia 10 filiżanek.

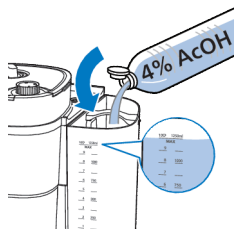

3 Zamknij pokrywkę zbiornika wody.

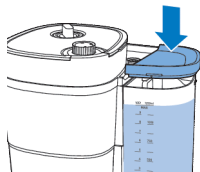

4 Chwyć zacisk, aby otworzyć uchwyt filtra.

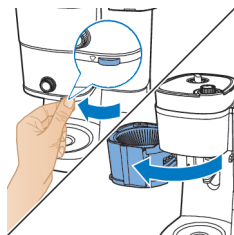

5 Włóż filtr papierowy (typ 1x4 lub nr 4) do koszyka filtra i zamknij uchwyt koszyka filtra.

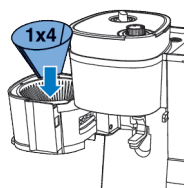

6 Włóż pusty dzbanek do ekspresu.

7 Włóż wtyczkę do gniazdka elektrycznego.

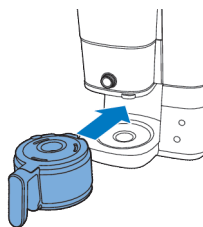

8 Naciśnij przycisk zasilania, aby włączyć ekspres. Wyświetlacz zacznie świecić.

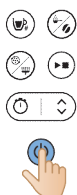

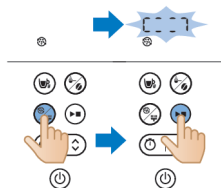

- 9** Naciśnij przycisk czyszczenia na ekspresie.
10 Wybierz ustawienie usuwania kamienia.
11 Naciśnij przycisk uruchomienia, aby potwierdzić wybór.
 - Ekspres automatycznie rozpocznie proces usuwania kamienia.

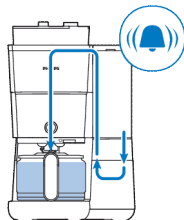

- 12** Poczekaj, aż urządzenie skończy parzenie roztworu do usuwania kamienia.
13 Po ukończeniu procesu usuwania kamienia dwukrotnie oplucz urządzenie przy maksymalnej ilości wody, aby usunąć wszelkie pozostałości.

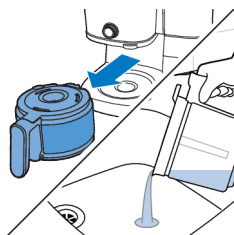

- 14** Opróżnij dzbanek i wyjmij filtr papierowy z resztkami kamienia.
15 Napełnij zbiornik czystą, zimną wodą i naciśnij przycisk uruchomienia, aby zacząć kolejny proces parzenia.
 Gdy urządzenie zakończy cały proces parzenia, opróżnij dzbanek.

Uwaga: jeśli to konieczne, powtarzaj krok 14, aż woda wypływająca z ekspresu nie będzie już pachnieć ani smakować octem.

- 16** Umyj koszyk filtra i dzbanek gorącą wodą i płynem do naczyń.
17 Naciśnij przycisk zasilania, aby wyłączyć urządzenie.

Rozwiązywanie problemów

W tym rozdziale opisano najczęstsze problemy, z którymi można się zetknąć, korzystając z urządzenia. Jeśli poniższe wskazówki okażą się niewystarczające do rozwiązania problemu, odwiedź stronę www.philips.com/support, na której znajduje się lista często zadawanych pytań, lub skontaktuj się z Centrum Obsługi Klienta w swoim kraju.

Możesz zeskanować ten kod QR, aby uzyskać dodatkową pomoc techniczną online.



Problem

Ekspres do kawy nie działa.

Rozwiązanie

Podłącz wtyczkę przewodu sieciowego do gniazdka elektrycznego i naciśnij wyłącznik, aby włączyć ekspres.

Upewnij się, że napięcie wskazane na ekspresie do kawy odpowiada lokalnemu napięciu w sieci.

Napełnij zbiornik wodą.

Zamknij pokrywkę lejka młynka.

Młynek nie działa lub działa niepoprawnie. Sprawdź, czy nie wybrano kawy mielonej. Jeśli na wyświetlaczu pokazuje się symbol kawy mielonej, oznacza to, że wybrano kawę mieloną.

Wyczyść lejek młynka zgodnie z instrukcjami.

Gdy używam młynka, kawa jest za słaba. Przekręć pokrętko i wybierz pożądany rozmiar (mała lub duża grubość).

Za pomocą przycisku wyboru mocy ustaw ją na 1, 2 lub 3 — większa cyfra oznacza większą moc.

Użyj ziaren kawy o większej mocy lub intensywniejszym smaku.

Gdy używam kawy mielonej, kawa jest za słaba. Sprawdź, czy ilość kawy mielonej w filtrze jest odpowiednia dla ilości wody w zbiorniku. Należy pamiętać, że ekspres zużywa całą wodę ze zbiornika.

Użyj kawy mielonej o większej mocy lub intensywniejszym smaku.

Aby zwiększyć moc kawy, zwiększ ilość kawy mielonej lub zmniejsz ilość wody.

Filtr się przelewa, kiedy wyjmuję dzbanek z ekspresu podczas parzenia kawy. Po wyjęciu dzbanka na dłużej niż 20 sekund podczas procesu parzenia blokada kapania spowoduje przelanie koszyka filtra. Pamiętaj także, że kawa nie osiągnie pełnego smaku przed zakończeniem procesu parzenia. Dlatego zalecamy nie usuwać dzbanka i nie nalewać kawy przed zakończeniem procesu parzenia.

Z ekspresu nadal kapie długo po zakończeniu procesu parzenia. Kapanie jest spowodowane skraplaniem się pary. Kapanie przez jakiś czas z ekspresu jest zupełnie normalne.

Kapanie nie ustaje. Przekręć pokrętko z trybu filiżanki do trybu dzbanka, aby otworzyć funkcję blokady kapania. Blokada zatrzyma kapanie z koszyka filtra.

Jeśli kapanie nie ustaje, blokada może być zapchana. Aby wyczyścić blokadę kapania, otwórz uchwyt koszyka filtra i wyjmij koszyk filtra. Przepłucz koszyk filtra i blokadę kapania pod kranem.

Kawa nie jest wystarczająco gorąca. Kawa w dzbanku stygnie szybciej, jeśli parzysz tylko kilka filiżanek. Kawa jest gorąca przez dłuższy czas, jeśli zaparzysz 10 filiżanek, czyli pełny dzbanek.

Usuń kamień z ekspresu do kawy.

Ziarna kawy szybko się zużywają. Aby zaparzyć idealną filiżankę kawy, w ekspresie musi być odpowiednia ilość zmielonej kawy. Ilość ziaren kawy, jaką ekspres zużywa do uzyskania optymalnej ilości zmielonej kawy na filiżankę, jest normalna.

Zegar nie działa. Należy zakończyć wszystkie etapy parzenia kawy z ziaren lub kawy mielonej przed ustawieniem zegara.

Kod błędu

Kod błędu Opis

Rozwiązanie

Uwaga

E1	Brak wody	Naciśnij dowolny przycisk, aby wprowadzić urządzenie w tryb gotowości. Napełnij zbiornik wody i ponownie uruchom urządzenie.	Jeśli problem się utrzymuje, wykonaj poniższe kroki: Naciśnij i przytrzymaj przyciski czyszczenia i uruchomienia jednocześnie przez trzy sekundy, aż urządzenie automatycznie rozpocznie pompować wodę przez jedną minutę. Powtórz proces 3 razy. Skontaktuj się z działem obsługi klienta, jeśli problem się utrzymuje.
E2	Zbiornik na ziarna jest niedostępny	Naciśnij dowolny przycisk, aby wprowadzić urządzenie w tryb gotowości. Zamocuj odpowiednio zbiornik na ziarna i uruchom ponownie urządzenie	Skontaktuj się z działem obsługi klienta, jeśli problem się utrzymuje.
E3	Awaria rurki do spieniania	Wymij wtyczkę urządzenia z gniazdka elektrycznego. Podłącz i uruchom urządzenie ponownie po całkowitym ostygnięciu.	Skontaktuj się z działem obsługi klienta, jeśli problem się utrzymuje.
E4	Blokada tarczy młynka	Wymij wtyczkę urządzenia z gniazdka elektrycznego. Podłącz i uruchom urządzenie ponownie. Wykonaj czynności czyszczenia lejka młynka, aby wyczyścić tarczę młynka i zsyp lejka.	Skontaktuj się z działem obsługi klienta, jeśli problem się utrzymuje.
E5	Blokada zsyphu lejka	Wymij wtyczkę urządzenia z gniazdka elektrycznego. Podłącz i uruchom urządzenie ponownie. Wykonaj czynności czyszczenia lejka młynka, aby wyczyścić zsyp lejka.	Skontaktuj się z działem obsługi klienta, jeśli problem się utrzymuje.
E6/E7/E8	Błąd programu	Wymij wtyczkę urządzenia z gniazdka elektrycznego. Podłącz i uruchom urządzenie ponownie.	Skontaktuj się z działem obsługi klienta, jeśli problem się utrzymuje.

Introdução

Parabéns pela sua aquisição e bem-vindo à Philips!

Para tirar o máximo partido da assistência oferecida pela Philips, registe o seu produto em: www.philips.com/welcome.

Descrição geral

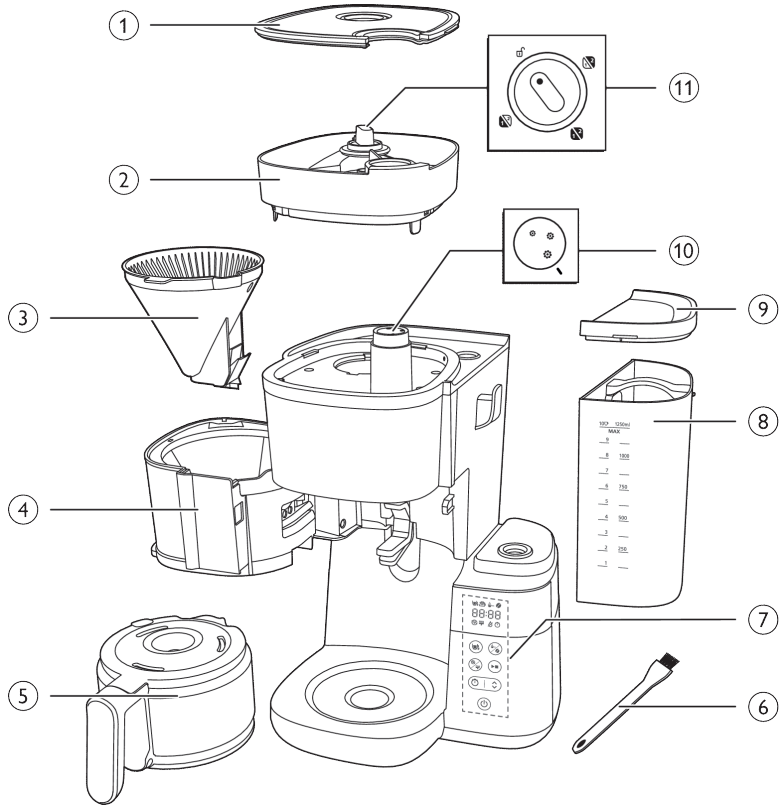

- 1 Tampa do recipiente para grãos
- 2 Recipiente para grãos
- 3 Cesto do filtro
- 4 Suporte do cesto do filtro
- 5 Jarro de vidro
- 6 Escova de limpeza da entrada dos grãos
- 7 Painel de controlo com visor
- 8 Reservatório para água
- 9 Tampa do reservatório para água
- 10 Botão de tipo de moagem
- 11 Botão de seleção do recipiente

Painel de controlo



Botão ligar/desligar



Botão do temporizador e botão de seta para ajustar o tempo



Botão iniciar/interromper



Botão de limpeza



Botão de intensidade do café e pré-moagem



Botão de seleção de chávenas

Ícone do visor



Número de chávenas



Modo para manter quente



Café pré-moído



Intensidade do café



Descalcificação



Alerta de limpeza manual



Reserva de água baixa



Temporizador



Visor de indicação das horas

Os dois primeiros dígitos representam as horas e os dois últimos dígitos representam os minutos.



Rode o botão para a posição de desbloqueio e pode remover o recipiente para grãos do aparelho.



Este botão seleciona o tipo de moagem do café, sendo que o tamanho maior indica um processamento mais grosso.



Modo de jarro

A função anti-pingos está disponível no modo de jarro.

Nota: O processo de preparação não para quando retira o jarro. Se não voltar a colocar o jarro no aparelho dentro de 20 segundos, o cesto do filtro transborda.



Modo de chávena

Comute manualmente o botão do modo de chávena para o modo de jarro para abrir o sistema anti-pingos para evitar pingas após a conclusão do ciclo de preparação

Nota: uma caneca de cerâmica fria absorve o calor do café à medida que aquece; pré-aqueça a chávena com água quente.

Importante

Aviso

- Verifique se a voltagem indicada no aparelho corresponde à voltagem elétrica local antes de o ligar.
- Ligue o aparelho a uma tomada com ligação à terra.
- Não utilize o aparelho se a ficha, o cabo de alimentação ou o próprio aparelho estiverem danificados.
- Se o cabo de alimentação estiver danificado, tem de ser substituído pela Philips, por um centro de assistência autorizado pela Philips ou por pessoal com qualificação equivalente para se evitarem situações de perigo.
- Este aparelho pode ser utilizado por crianças com idade igual ou superior a 8 anos e por pessoas com capacidades físicas, sensoriais ou mentais reduzidas, ou com falta de experiência e conhecimento, caso tenham sido supervisionadas ou lhes tenham sido dadas instruções relativas à utilização segura do aparelho e se tiverem sido alertadas para os perigos envolvidos. A limpeza e a manutenção não podem ser efetuadas por crianças, a não ser que tenham idade superior a 8 anos e sejam supervisionadas. Mantenha o aparelho e o cabo fora do alcance de crianças com idade inferior a 8 anos.
- As crianças não podem brincar com o aparelho.
- Não deixe que o cabo de alimentação fique pendurado na extremidade da mesa ou bancada onde o aparelho se encontra.

- Utilize este aparelho apenas para o fim a que se destina, de modo a evitar potenciais perigos ou ferimentos.

Atenção

- Lave sempre o aparelho com água limpa antes da primeira utilização.
- Não coloque o aparelho sobre uma superfície quente e não deixe que o cabo de alimentação entre em contacto com superfícies quentes.
- Não coloque o aparelho num armário durante a utilização.
- Desligue o aparelho da tomada elétrica antes de o limpar e se ocorrerem problemas durante a preparação.
- Limpe sempre o aparelho depois de este arrefecer.
- Durante a preparação e quando no modo para manter quente, o depósito de água, o suporte do filtro, a placa de aquecimento, a parte inferior do aparelho e o jarro cheio de café permanecem quentes mesmo após algum tempo.
- Não coloque o jarro num fogão ou num micro-ondas para reaquecer o café.
- Este aparelho destina-se à utilização em ambientes domésticos e aplicações semelhantes, como quintas, ambientes de "alojamento e pequeno-almoço", copas de pessoal em lojas, escritórios e outros ambientes de trabalho, e por clientes em hotéis, motéis e outros tipos de ambientes residenciais.
- Leve sempre o aparelho a um centro de assistência autorizado da Philips para verificação ou reparação. Não abra o aparelho nem o tente reparar sozinho.
- A superfície da resistência, o suporte do filtro, a parte inferior do aparelho, a placa de aquecimento e o jarro cheio de café estão sujeitos a calor residual durante algum tempo após a utilização.
- A não ser que seja indicado o contrário, todos os materiais da embalagem são fabricados com papel reciclado; consulte a marca PAP na embalagem.

Descalcificação

- Descalcifique a máquina de café quando verificar a presença de um alerta de descalcificação no visor. Utilize apenas vinagre branco para efetuar a descalcificação, uma vez que a utilização de outros produtos pode danificar o aparelho.

Campos eletromagnéticos (CEM)

Este aparelho Philips está em conformidade com as normas relacionadas com campos eletromagnéticos (CEM).

Reciclagem



Este símbolo significa que este produto não deve ser eliminado juntamente com os resíduos domésticos comuns (2012/19/UE).

Siga as normas do seu país para a recolha seletiva de produtos elétricos e eletrónicos. A eliminação correta ajuda a evitar consequências prejudiciais para o meio ambiente e para a saúde pública.

A não ser que seja indicado o contrário, todos os materiais da embalagem são fabricados com papel reciclado; consulte a marca PAP na embalagem.

Garantia e assistência

A Versuni oferece uma garantia de dois anos após a compra deste produto. Esta garantia não é válida se um defeito se dever a uma utilização incorreta ou a uma manutenção deficiente. A nossa garantia não afeta os seus direitos enquanto consumidor abrangidos pela lei. Para obter mais informações ou invocar a garantia, visite o nosso website www.philips.com/support.

Antes da primeira utilização

Certifique-se de que limpa o suporte do filtro e o filtro permanente após cada utilização.

Limpe bem o suporte do filtro com um pano seco após cada utilização. Certifique-se de que limpa qualquer acumulação de condensação.

Acertar o relógio

- 1 Ligue o aparelho à corrente.
 - O visor de indicação das horas fica intermitente.

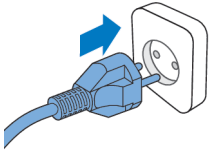

08:00



- 2 Utilize o botão de seta para ajustar a hora.

08:



- 3 Assim que a hora estiver definida, prima o botão do temporizador para confirmar a hora.



08:06



08:06



08:06

- 4 A indicação dos minutos fica intermitente. Utilize o botão de seta para ajustar os minutos.
- 5 Prima o botão do temporizador para confirmar os minutos.

- A hora atual está agora definida e guardada.
- 6 Para ajustar o temporizador no modo de espera, pode optar por uma das seguintes abordagens:
 - Desligue o aparelho da corrente e ligue-o novamente.
 - Prima continuamente o botão do temporizador até que os dígitos das horas fiquem intermitentes.

Nota

O aparelho guarda sempre a última definição.

Tempo para manter quente

Pode escolher durante quanto tempo pretende que o seu café fique quente após a preparação, ajustando o tempo após o qual o aparelho se desliga automaticamente. O tempo de desativação automática predefinido é de 30 minutos. O tempo máximo de desativação automática é de 300 minutos.

Para ajustar o tempo de desativação automática, siga os passos abaixo:

- 1 Desligue o aparelho e mantenha-o ligado à corrente.
- 2 Prima continuamente o botão de limpeza até que o ícone de manter quente seja apresentado e a hora fique intermitente.
- 3 Siga o passo em "Acertar o relógio" para concluir a definição.

Lavar o aparelho

Lave sempre a máquina de café uma vez antes da primeira utilização, seguindo os passos abaixo.

Aviso: nunca deite água no recipiente para grãos, uma vez que tal danifica a máquina de café.

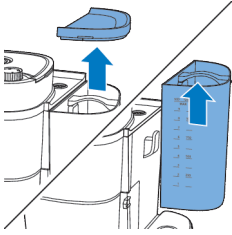

1 Abra a tampa do reservatório da água.

Cuidado: não coloque grãos de café ou café pré-moído no reservatório da água

2 Pode encher o reservatório da água com água seguindo uma das formas apresentadas abaixo:



- Levante o depósito do aparelho e coloque-o debaixo da torneira para encher com água.

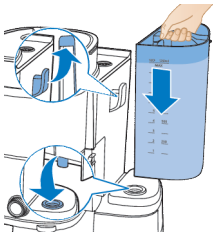

- Certifique-se de que o gancho está bem fixado ao colocar novamente no devido lugar.
- Agarre na patilha da tampa para puxar a tampa do jarro para cima. Coloque o jarro do café debaixo da torneira para encher com água. Encha o depósito de água com o jarro do café.
- Certifique-se de que a água está abaixo do nível máximo.

3 Feche a tampa do reservatório da água.

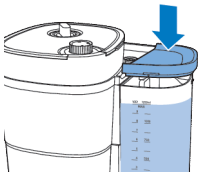

4 Coloque o jarro do café no aparelho.

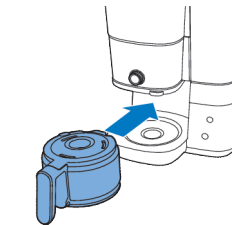

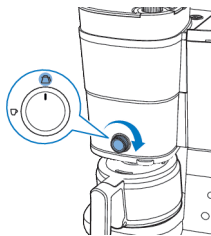

5 Rode o botão central para ajustar o jarro.

☕ 10 3

6 Prima o botão ligar/desligar.

- O aparelho é ligado.



7 Prima o botão de intensidade do café e selecione café pré-moído.



8 Prima o botão de chávena e selecione 10 chávenas.



9 Prima o botão iniciar.



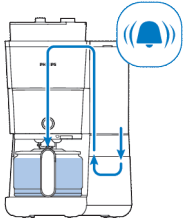

10 O aparelho inicia o processo de lavagem.

11 Deixe o aparelho a funcionar até o processo de lavagem estar concluído.



12 Esvazie o jarro de vidro.

Utilizar o aparelho

Utilizar grãos de café

Nota: a máquina de café irá utilizar a quantidade de água necessária com base no número de châvenas de café a preparar

Para utilizar, siga os passos abaixo:

1 Abra a tampa do reservatório da água e retire o depósito do aparelho.

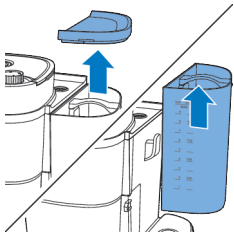

2 Encha o depósito com água da torneira.

- Certifique-se de que o nível de água está abaixo do nível máximo.



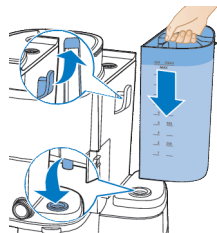

- 3 Volte a colocar o depósito no aparelho.
- Certifique-se de que o gancho está bem fixado.

- 4 Feche a tampa do recipiente de água.

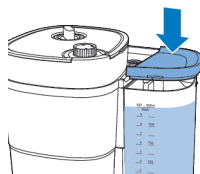

- 5 Levante a tampa do recipiente para grãos.

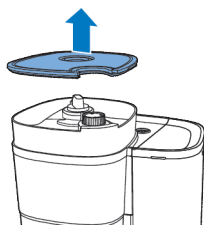

- 6 Adicione os grãos de café pretendidos ao recipiente.

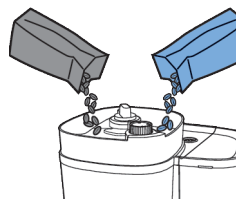

Nota: certifique-se sempre de que o recipiente duplo para grãos frescos está, no mínimo, meio cheio.

Aviso: para evitar que o moinho encrave, não utilize grãos caramelizados ou não torrados. Utilize grãos de café em vez de grãos de café expresso, uma vez que os grãos de café expresso podem danificar o moinho.

- 7 Feche a tampa do recipiente para grãos.

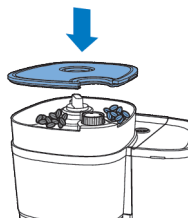

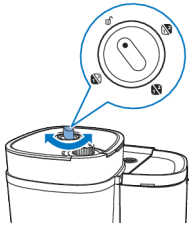

- 8** Rode o botão de seleção do recipiente para escolher os grãos pretendidos entre os dois recipientes.
- Pode até misturar dois tipos diferentes de grãos para obter uma mistura única.

Nota: sempre que mudar de recipiente de grãos de café ou mudar de tipo de grãos de café, haverá sempre vestígios de café do tipo de grãos de café moídos anteriormente. Para evitar que tal aconteça, limpe o funil do moinho depois de mudar para um novo tipo de grãos de café.

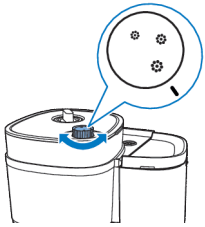

- 9** Escolha o nível de moagem pretendido utilizando o botão.

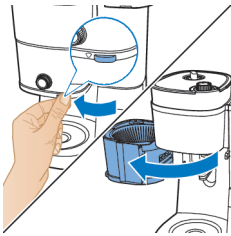

- 10** Agarre na patilha para abrir o suporte do filtro.

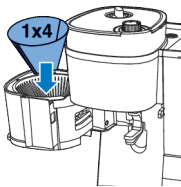

- 11** Coloque um filtro de papel (tipo 1x4 ou o n.º 4) no cesto do filtro.

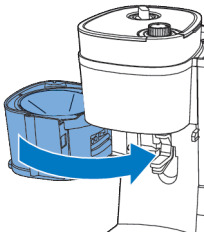

- 12** Feche o suporte do filtro

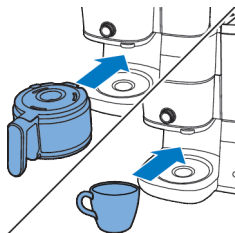

13 Coloque o jarro do café ou a chávena sob o dispensador.

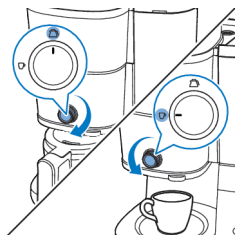

14 Utilize o botão para selecionar a quantidade de café que pretende preparar.

Ao utilizar a função de preparar para a chávena, pode utilizar canecas de vidro ou de cerâmica, bem como copos. Certifique-se de que utiliza chávenas com menos de 10 cm de altura.

W 3



15 Ligue o aparelho.

W 3



16 Selecione o número de chávenas que pretende servir premindo o botão de chávena.

W 2



17 Prima o botão de intensidade para escolher a intensidade do café pretendida.

- 1: grãos para café suave
- 2: grãos para café médio a forte
- 3: grãos para café forte



18 Inicie o processo premindo o botão iniciar/interromper.

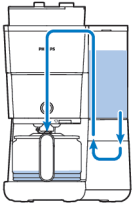

19 O aparelho dá início ao processamento.

- O aparelho emite um sinal sonoro quando terminar.

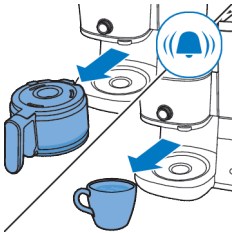

20 Retire a chávena ou o jarro do café do aparelho.

A função anti-pingos permite-lhe remover o jarro da máquina de café antes de o processo de preparação terminar. Quando retirar o jarro, o sistema anti-pingos interrompe o fluxo de café para o jarro.

O processo de preparação não para quando retira o jarro. Se não voltar a colocar o jarro no aparelho dentro de 20 segundos, o cesto do filtro transborda.



21 Desfrute do seu café acabado de preparar.



22 Para desligar o aparelho, prima continuamente o botão iniciar/interromper durante três segundos.

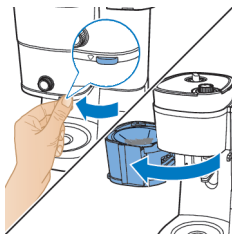

23 Abra o suporte do filtro.

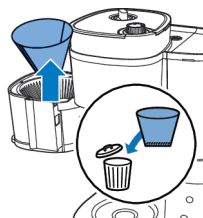

24 Remova o filtro de papel utilizado.

A função de manter quente não é ativada ao preparar uma ou duas chávenas.

O aparelho irá manter a bebida quente até se desligar automaticamente. Se não pretender manter a bebida quente, prima o botão ligar/desligar para desligar o aparelho.

Utilizar café pré-moído

Para utilizar, siga os passos abaixo:

- 1** Verifique se o aparelho tem água suficiente para preparar a quantidade pretendida de café.



- 2** Agarre na patilha para abrir o suporte do filtro.

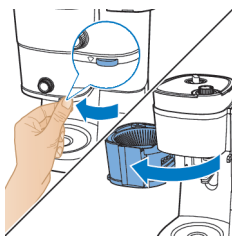

- 3** Coloque um filtro de papel (tipo 1x4 ou o n.º 4) no cesto do filtro.

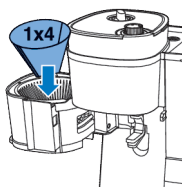

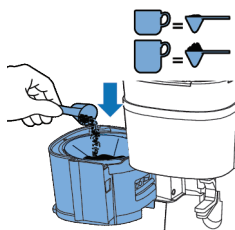

- 4** Adicione a quantidade de café pré-moído no filtro de papel. Esta varia consoante a sua preferência pessoal.
- Para uma chávena de café padrão, utilize 6 gramas de café moído ou 1 colher de sopa.

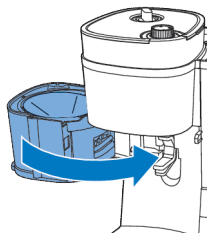

- 5** Feche o suporte do filtro.

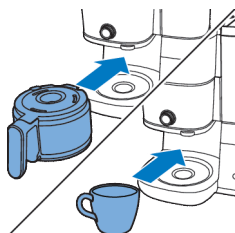

- 6** Coloque o jarro do café ou a chávena sob o dispensador.

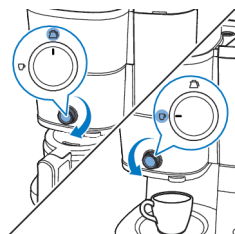

- 7** Utilize o botão para selecionar a quantidade de café que pretende preparar.

- 8** Ligue o aparelho.

WS 10 3





- 9** Selecione a utilização de café pré-moído premindo o botão de seleção do modo.

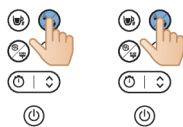

- 10** Selecione o número de chávenas que pretende servir premindo o botão de chávena.

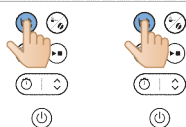

- 11** Inicie o processo premindo o botão iniciar/interromper.



- 12** O aparelho dá início ao processamento.
- O aparelho emite um sinal sonoro quando terminar.

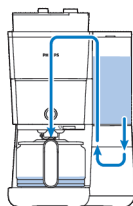

- 13** Retire a chávena ou o jarro do café do aparelho.

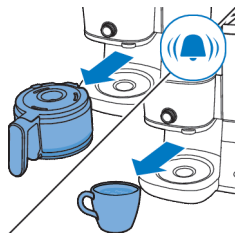



14 Desfrute do seu café acabado de preparar.



15 Para desligar o aparelho, prima continuamente o botão iniciar/interromper durante três segundos.

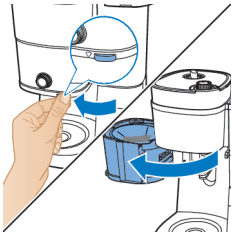

16 Abra o suporte do filtro.

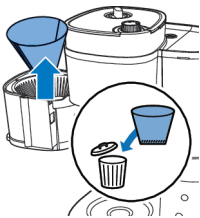

17 Remova o filtro de papel utilizado.

Programar o temporizador

Para programar o temporizador no aparelho, siga estes passos:

1 Ligue a máquina de café.

08:05 

- 2 Prima o botão do temporizador e o ícone do temporizador aparecerá no visor. Os dígitos das horas ficam intermitentes para indicar que pode ajustar as horas.

08:00



- 3 Utilize o botão de seta para ajustar as horas. Se precisar de ajustar rapidamente, prima continuamente o botão de seta.

08: 

- 4 Prima o botão do temporizador para confirmar a definição das horas. Os dígitos dos minutos indicam que pode ajustar os minutos.

08:05



- 5 Utilize novamente o botão de seta para ajustar os minutos. Se precisar de ajustar rapidamente, prima continuamente o botão de seta.

08:05 

- 6 Prima novamente o botão do temporizador para confirmar a definição dos minutos.

Para cancelar o temporizador, basta premir o botão do temporizador e o ícone do temporizador desaparece do visor.

A função anti-pingos permite-lhe remover o jarro da máquina de café antes de o processo de preparação terminar. Quando retirar o jarro, o sistema anti-pingos interrompe o fluxo de café para o jarro.

Nota: o processo de preparação não para quando retira o jarro. Se não voltar a colocar o jarro no aparelho dentro de 20 segundos, o cesto do filtro transborda.

Limpeza e manutenção

Limpeza após cada utilização

Nunca mergulhe a máquina de café em água ou noutro líquido, nem a enxague em água corrente.

- 1 Retire a ficha de alimentação da tomada.

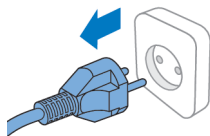









- 2 Limpe o exterior da máquina de café com um pano húmido.
- 3 Limpe o cesto do filtro com água quente e um pouco de detergente da loiça ou lave-o na máquina de lavar loiça.



- 4 Enxague o jarro do café e a tampa em água corrente. Ou lave-os na máquina de lavar loiça.

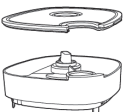

			
	✓	✓	✓
	✓	✓	✓
	✓	✓	✓
	✓	✗	✓
	✓	✗	✓

Limpar o funil do moinho

Importante:

limpe o funil do moinho a cada 1 a 2 semanas para evitar obstruções com café moído. Isto é conseguido de forma fácil e rápida seguindo os passos abaixo.

Limpe o funil do moinho quando verificar a presença de um alerta de escova no visor.

Nota: certifique-se de que o recipiente para grãos de café está vazio antes de iniciar o procedimento de limpeza.

- 1 Ligue o aparelho à corrente.

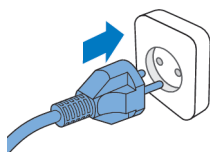

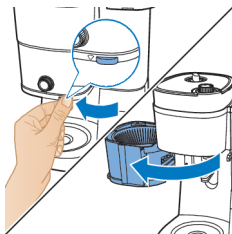

2 Abra o suporte do filtro para aceder à entrada do funil para café moído.

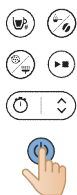

3 Ligue a máquina de café.

4 Prima o botão de limpeza no painel de controlo da máquina.

5 Selecione a definição da escova no ecrã do visor.



6 Prima o botão iniciar. Isto fará com que a aba da entrada do funil para café moído abra, permitindo que limpe a entrada com uma escova.

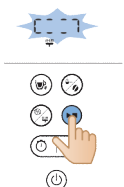

7 Utilize uma escova para remover quaisquer vestígios de café moído ou resíduos que possam estar acumulados na entrada.

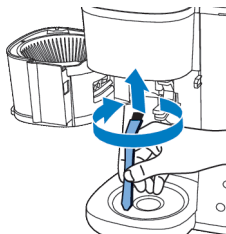



- 8 Depois de limpar a entrada, prima novamente o botão de iniciar para fechar a aba.

Descalcificar a máquina de café

Descalcifique a máquina de café quando verificar a presença de um alerta de descalcificação no visor. Utilize apenas vinagre branco para efetuar a descalcificação, uma vez que a utilização de outros produtos pode danificar a máquina de café.

Aviso: nunca utilize vinagre com um teor de ácido acético igual ou superior a 8%, vinagre natural ou descalcificadores em pó ou pastilhas para descalcificar a máquina, uma vez que podem causar danos.

- 1 Abra a tampa do reservatório da água.

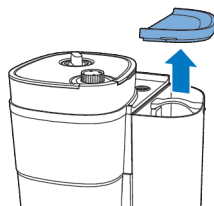

- 2 Encha o reservatório da água com vinagre branco (4% de ácido acético) até à indicação de 10 chávenas.

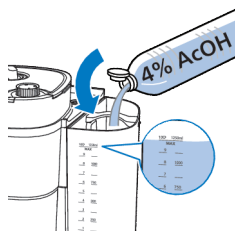

- 3** Feche a tampa do recipiente de água.

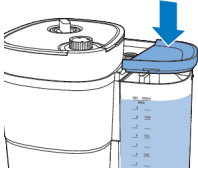

- 4** Agarre na patilha para abrir o suporte do filtro.

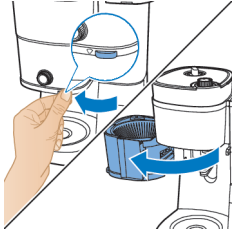

- 5** Coloque um filtro de papel (tipo 1x4 ou o n.º 4) no cesto do filtro e feche o suporte do cesto do filtro.

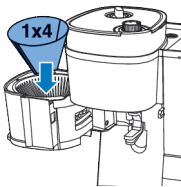

- 6** Coloque o jarro vazio na máquina de café.
7 Introduza a ficha de alimentação na tomada elétrica.

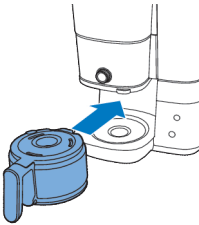

- 8** Prima o botão de alimentação para ligar a máquina de café. O visor acende-se.

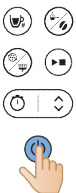

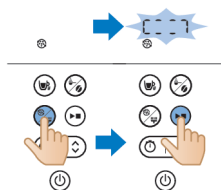

- 9 Prima o botão de limpeza na máquina de café.
 - 10 Selecione a definição de descalcificação.
 - 11 Prima o botão de iniciar para confirmar a sua seleção.
- A máquina de café inicia automaticamente o processo de descalcificação.

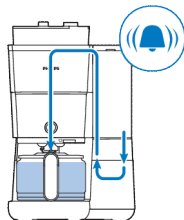

- 12 Aguarde até que a máquina termine a preparação da solução de descalcificação.
- 13 Assim que o processo de descalcificação estiver concluído, enxague a máquina duas vezes com a quantidade máxima de água para remover completamente quaisquer depósitos.

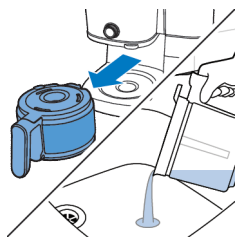

- 14 Esvazie o jarro e retire o filtro de papel com os resíduos de calcário.
 - 15 Encha o reservatório da água com água fria e prima o botão de iniciar para iniciar outro processo de preparação.
- Aguarde até que a máquina de café complete todo o processo de preparação e esvazie o jarro.

Nota: se necessário, repita o passo 14 até que a água que sai da máquina de café não apresente um sabor ou cheiro a vinagre.

- 16 Limpe o cesto do filtro e o jarro com água quente e um pouco de detergente da loiça.
- 17 Prima o botão de alimentação para desligar o aparelho.

Resolução de problemas

Este capítulo resume os problemas mais comuns que podem surgir na máquina. Se não conseguir resolver o problema com as informações fornecidas abaixo, visite www.philips.com/support para consultar uma lista de perguntas frequentes ou contacte o Centro de Apoio ao Cliente no seu país. Também pode ler este código QR para obter apoio online adicional.



Problema

A máquina de café não funciona.

Solução

Ligue a ficha de alimentação a uma tomada elétrica e prima o botão ligar/desligar para ligar a máquina de café.

Certifique-se de que a tensão indicada na máquina de café corresponde à tensão elétrica local.

Encha o reservatório da água com água.

Feche a tampa do funil do moinho.

O moinho não funciona ou não funciona corretamente. Certifique-se de que não selecionou café pré-moído. Se o símbolo de café pré-moído estiver visível no visor, tal significa que selecionou café pré-moído.

Limpe o funil do moinho seguindo as instruções.

Quando utilizo o moinho, o café fica muito fraco. Rode o botão de tipo de moagem para selecionar o tipo de moagem pretendido, de fino a grosso.

Utilize o botão de seleção de intensidade para definir a intensidade do café de 1 a 3; quanto maior for o dígito, maior é a intensidade.

Utilize grãos de café de uma mistura ou sabor mais forte.

Quando utilizo café pré-moído, o café fica muito fraco. Certifique-se de que a quantidade de café pré-moído no filtro é consistente com a quantidade de água no reservatório da água. Tenha em atenção que a máquina de café utiliza toda a água existente no reservatório da água.

Utilize café moído de uma mistura ou sabor mais forte.

Para aumentar a intensidade do café, aumente a quantidade de café pré-moído ou diminua a quantidade de água.

O filtro transborda quando removo o jarro da máquina de café durante a preparação. Se retirar o jarro durante mais de 20 segundos durante o processo de preparação, o sistema anti-pingos faz com que o cesto do filtro transborde. Além disso, tenha em atenção que o café só atinge o seu sabor rico depois de o processo de preparação estar concluído. Por conseguinte, recomendamos que não retire o jarro para servir café antes da conclusão do processo de preparação.

A máquina de café continua a pingar durante muito tempo depois do processo de preparação terminar. Isto é causado pela condensação de vapor. É completamente normal que a máquina de café pingue durante algum tempo.

Não espere pelas últimas pingas. Mude o botão do modo de chávena para o modo de jarro para ativar a função anti-pingos; o sistema anti-pingos para as pingas provenientes do cesto do filtro.

Se as pingas não pararem, o sistema anti-pingos pode estar obstruído. Para limpar o sistema anti-pingos, abra o suporte do cesto do filtro e retire o cesto do filtro. Enxague o cesto do filtro e o sistema anti-pingos em água corrente.

O café não sai suficientemente quente. O café no jarro arrefece mais rapidamente se preparar café para poucas chávenas. O café permanece quente durante mais tempo se preparar 10 chávenas, o que corresponde a um jarro cheio.

Descalcifique a máquina de café.

A máquina de café parece ficar sem grãos de café muito rapidamente.

Para preparar uma chávena de café perfeita, a máquina de café precisa de uma determinada quantidade de café moído. A quantidade de grãos de café que a máquina de café utiliza para obter a quantidade ideal de café moído por chávena é normal.

O temporizador não funciona.

Certifique-se de que conclui todos os passos de preparação de café com grãos de café ou café pré-moído antes de programar o temporizador.

Código de erro

Código de erro	Descrição	Solução	Comentário
E1	Falta de água	Prima qualquer botão para colocar o aparelho no modo de espera. Encha o depósito de água e reinicie o aparelho.	Se este problema persistir, siga os seguintes passos: Prima continuamente o botão de iniciar e o botão de limpeza em simultâneo durante três segundos, até o aparelho começar a bombear água automaticamente durante um minuto. Repita este processo 3 vezes. Se o problema persistir, contacte o serviço de apoio ao cliente.
E2	Recipiente para grãos indisponível	Prima qualquer botão para colocar o aparelho no modo de espera. Fixe bem o recipiente para grãos e reinicie o aparelho	Se o problema persistir, contacte o serviço de apoio ao cliente.
E3	Avaria no tubo de aquecimento	Desligue o aparelho da tomada elétrica. Ligue a ficha à tomada e ligue novamente o aparelho até este arrefecer completamente.	Se o problema persistir, contacte o serviço de apoio ao cliente.
E4	Obstrução da roda de trituração	Desligue o aparelho da tomada elétrica. Ligue a ficha à tomada e ligue novamente o aparelho. Siga os passos em "Limpar o funil do moinho" para limpar a roda de trituração e a entrada do funil para café moído.	Se o problema persistir, contacte o serviço de apoio ao cliente.

E5	Obstrução da entrada do funil para café moído	Desligue o aparelho da tomada elétrica. Ligue a ficha à tomada e ligue novamente o aparelho. Siga os passos em "Limpar o funil do moinho" para limpar a entrada do funil para café moído.	Se o problema persistir, contacte o serviço de apoio ao cliente.
E6/E7/E8	Erro do programa	Desligue o aparelho da tomada elétrica. Ligue a ficha à tomada e ligue novamente o aparelho.	Se o problema persistir, contacte o serviço de apoio ao cliente.

Introducere

Felicitări pentru achiziție și bun venit la Philips!

Pentru a beneficia pe deplin de asistența oferită de Philips, înregistrează-ți produsul la www.philips.com/welcome.

Descriere generală

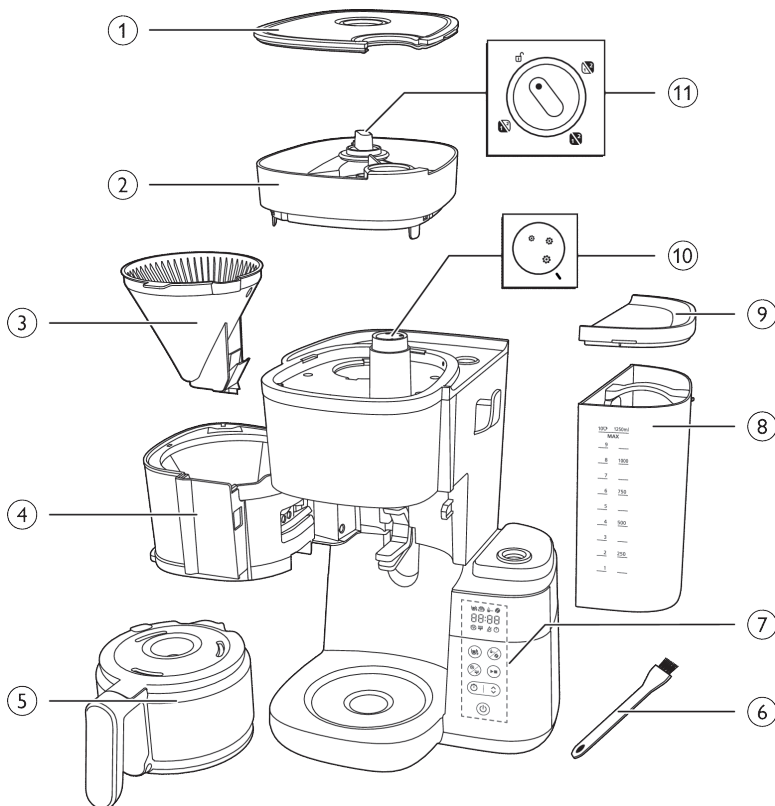

- 1 Capac recipient pentru boabe de cafea
- 2 Recipient pentru boabe de cafea
- 3 Coșul filtrului
- 4 Suport pentru coșul filtrului
- 5 Cană din sticlă
- 6 Perie de curățat canalul pentru boabe de cafea
- 7 Panou de comandă cu afișaj
- 8 Rezervor de apă
- 9 Capac de rezervor de apă
- 10 Buton de granulație
- 11 Buton de selectare a recipientului

Panou de control



Buton de pornire



Buton temporizator și buton săgeată pentru reglarea orei



Butonul Start/pauză



Buton pentru curățare



Buton pentru cafea premăcinată și pentru tărie



Buton de selectare a ceștii

Pictogramă afișată



Număr de cești



Mod de păstrare la cald



Cafea premăcinată



Tăria cafelei



Decalcifiere



Alertă de curățare manuală



Rezervă de apă scăzută



Temporizator



Afișarea orei

Primele două cifre reprezintă orele, iar ultimele două cifre reprezintă minutele.



Rotește butonul la poziția de deblocare, apoi poți scoate recipientul pentru boabe de cafea din aparat.



Acest buton selectează granulația cafelei; o dimensiune mai mare înseamnă o prelucrare mai grosieră.



Modul cană

În modul cană există o funcție de oprire a picurării.

Notă: Procesul de preparare nu se oprește când scoți cana. Dacă nu pui cana la loc în aparat în decurs de 20 de secunde, coșul filtrului se revarsă.



Modul ceașcă

Comută manual butonul de la modul ceașcă la modul cană pentru a deschide opritorul de picurare, pentru a preveni picurarea după terminarea ciclului de preparare.

Notă: O ceașcă ceramică rece va prelua din căldura cafelei până se încălzește; folosește o ceașcă preîncălzită cu apă caldă.

Important

Avertisment

- Înainte de a conecta aparatul, verifică dacă tensiunea indicată pe aparat corespunde tensiunii de alimentare locale.
- Conectați aparatul numai la o priză de perete cu împământare.
- Nu folosi aparatul dacă ștecherul, cablul de alimentare sau aparatul însuși este deteriorat.
- În cazul în care cablul de alimentare este deteriorat, acesta trebuie înlocuit întotdeauna de Philips, de un centru de service autorizat de Philips sau de personal calificat în domeniu, pentru a evita orice accident.
- Acest aparat poate fi utilizat de către copii începând de la vârsta de 8 ani și persoane care au capacități fizice, senzoriale sau mentale reduse sau sunt lipsite de experiență și cunoștințe, dacă sunt supravegheate sau au fost instruite cu privire la utilizarea în condiții de siguranță a aparatului și înțeleg pericolul pe care le prezintă. Curățarea și întreținerea de către utilizator nu trebuie efectuate de copii, decât dacă aceștia au vârsta de peste 8 ani și sunt supravegheați. Nu lăsa aparatul și cablul acestuia la îndemâna copiilor cu vârsta sub 8 ani.
- Copiii nu trebuie să se joace cu aparatul.
- Nu lăsa cablul de alimentare să atârne peste marginea mesei sau a blatului pe care este așezat aparatul.

- Folosește acest aparat numai în scopul prevăzut, pentru a evita potențialele pericole sau vătămări.

Atenție

- Clătește întotdeauna aparatul cu apă curată înainte de prima utilizare.
- Nu amplasa aparatul pe o suprafață fierbinte și nu lăsa cablul de alimentare să intre în contact cu suprafețe fierbinți.
- Nu amplasa aparatul într-un dulap atunci când este în folosință.
- Scoate aparatul din priză înainte de a-l curăța și dacă apar probleme în timpul preparării.
- Curăță întotdeauna aparatul după ce acesta se răcește.
- În timpul preparării și al funcției de păstrare la cald, rezervorul de apă, suportul de filtru, plita, partea inferioară a aparatului și cana plină cu cafea sunt fierbinți chiar și după câțva timp.
- Nu pune cana pe o plită sau într-un cuptor cu microunde pentru a reîncălzi cafeaua.
- Acest aparat este destinat uzului domestic și aplicațiilor similare, precum ferme, medii în care se oferă servicii de tip cazare și mic dejun, zona bucătăriei pentru personalul din magazine, birouri și alte medii de lucru și de către clienți în hoteluri, moteluri și alte medii de tip rezidențial.
- Pentru verificare sau reparații, du aparatul numai la un centru de service Philips autorizat. Nu deschide aparatul și nu încerca să-l repari pe cont propriu.
- Suprafața elementului de încălzire, suportul de filtru, partea inferioară a aparatului, plita și cana plină cu cafea sunt supuse căldurii reziduale pentru o perioadă după utilizare.
- Cu excepția cazului în care se indică altfel, toate materialele de ambalare din cutie sunt fabricate din hârtie reciclată; vezi marcajul PAP de pe cutie.

Decalcifiere

- Detartrează cafetiera când observi că a apărut alerta de detartrare pe afișaj. Folosește doar oțet alb pentru detartrare, deoarece alte produse pot deteriora aparatul.

Câmpuri electromagnetice (EMF)

Acest aparat Philips respectă standardele referitoare la câmpuri electromagnetice (EMF).

Reciclarea



Acest simbol înseamnă că produsul nu poate fi eliminat împreună cu gunoii menajer obișnuit (2012/19/UE).

Urmează regulile din țara ta pentru colectarea separată a produselor electrice și electronice. Eliminarea corectă contribuie la prevenirea consecințelor negative asupra mediului și asupra sănătății umane.

Cu excepția cazului în care se indică altfel, toate materialele de ambalare din cutie sunt fabricate din hârtie reciclată; vezi marcajul PAP de pe cutie.

Garanție și asistență

Versuni oferă o garanție de doi ani după achiziția acestui produs. Această garanție nu este valabilă dacă o defecțiune se datorează utilizării incorecte sau întreținerii necorespunzătoare. Garanția noastră nu îți afectează drepturile de consumator conferite prin lege. Pentru mai multe informații sau pentru revendicarea garanției, accesează site-ul nostru web www.philips.com/support.

Înainte de prima utilizare

Ai grijă să cureți suportul de filtru și filtrul permanent după fiecare utilizare.

Șterge bine suportul de filtru cu o cârpă uscată după fiecare utilizare. Ai grijă să cureți orice acumulare de condens.

Setarea ceasului

- 1 Conectează aparatul.
 - Afișajul orei va începe să lumineze intermitent.

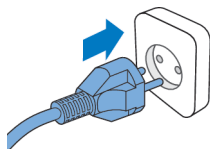

08:00



- 2 Folosește butonul săgeată pentru a regla ora.

08:



- 3 După ce ora este setată, apasă butonul de temporizare pentru a confirma ora.

08:06



- 4 Afișajul minutelor va începe să lumineze intermitent. Folosește butonul săgeată pentru a regla minutele.

08:06



- 5 Apasă butonul de temporizare pentru a confirma minutele.



08:06

- Ora curentă este acum setată și salvată.
- 6 Pentru a regla temporizatorul în modul standby, poți folosi una dintre cele două metode de mai jos:
 - Scoate aparatul din priză și apoi introdu-l din nou.
 - Apasă și menține apăsat butonul de temporizare până când cifrele orei încep să lumineze intermitent.

Notă

Aparatul salvează întotdeauna ultima setare

Durata de păstrare la cald

Poți alege cât timp dorești să fie păstrată la cald cafeaua după preparare prin reglarea duratei după care aparatul se oprește automat. Durata implicită pentru oprire automată este de 30 de minute. Durata maximă pentru oprire automată este de 300 de minute.

Pentru a regla durata pentru oprire automată, urmează pașii de mai jos:

- 1 Oprește aparatul și lasă-l în priză.
- 2 Apasă și menține apăsat butonul de curățare până când pictograma pentru menținere la cald și ora încep să lumineze intermitent.
- 3 Urmează pașii de la „Setarea ceasului” pentru a finaliza setarea.

Clătirea aparatului

Clătește întotdeauna cafetiera o dată înainte de prima utilizare, urmând pașii de mai jos.

Avertisment: Nu turna niciodată apă în recipientul pentru boabe de cafea, deoarece acest lucru deteriorează cafetiera.

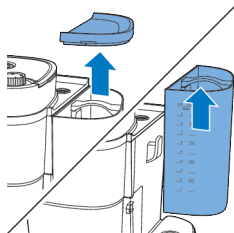

1 Deschide capacul rezervorului de apă.

Atenție: Nu pune boabe de cafea sau cafea premăcinată în rezervorul de apă

2 Poți umple rezervorul de apă cu apă în oricare dintre modurile de mai jos:

- Scoate rezervorul din aparat și pune-l sub un robinet pentru a-l umple cu apă.



- Ai grijă să fie corect atașat cârligul când pui rezervorul la loc.

- Prinde urechea capacului pentru a trage capacul cănii. Pune cana de cafea sub robinet pentru a o umple cu apă. Umple rezervorul de apă cu cana pentru cafea.

- Ai grijă ca apa să fie sub nivelul maxim.

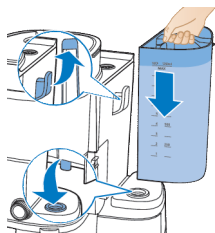

3 Închide capacul rezervorului de apă.

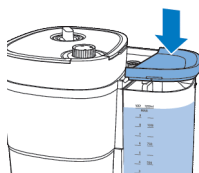

4 Pune cana pentru cafea în aparat.

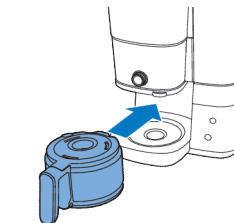

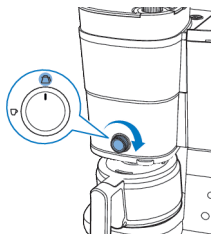

5 Rotește butonul central la setarea pentru cană.

10 3



6 Apasă butonul de pornire/oprire.

- Aparatul este pornit.



7 Apasă butonul pentru tăria cafelei și selectează cafea premăcinată.

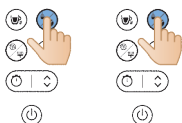

8 Apasă butonul pentru ceașcă și selectează 10 cești.

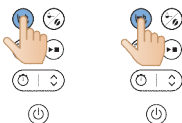

9 Apasă butonul de start.



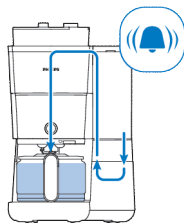

10 Aparatul începe procesul de clătire.

11 Lasă aparatul să funcționeze până când procesul de clătire este finalizat.



12 Golește cana din sticlă.

Utilizarea aparatului

Utilizarea boabelor de cafea

Notă: cafetiera va folosi cantitatea necesară de apă în funcție de numărul de cești de cafea de preparat.

Urmează pașii de mai jos pentru utilizare:

1 Deschide capacul rezervorului de apă și scoate rezervorul din aparat.

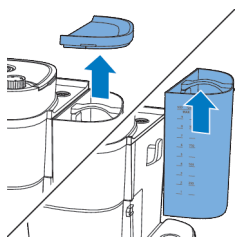

2 Umple rezervorul cu apă de la robinet.

- Asigură-te că apa este sub nivelul maxim.



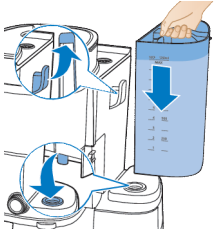

- 3 Pune rezervorul înapoi în aparat.
- Ai grijă să fie corect atașat cârligul.

- 4 Închide capacul recipientului pentru apă.

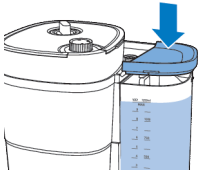

- 5 Deschide capacul recipientului pentru boabe de cafea.

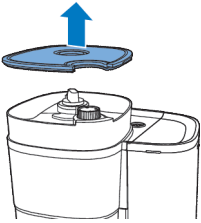

- 6 Pune boabele de cafea dorite în recipient.

Notă: Ai grijă ca recipientul dublu pentru boabe de cafea proaspătă să fie plin cel puțin pe jumătate.

Avertisment: Pentru a preveni blocarea râșniței, nu folosi boabe de cafea neprăjită sau caramelizată. Folosește boabe de cafea în loc de boabe de espresso, deoarece boabele de espresso pot deteriora râșnița.

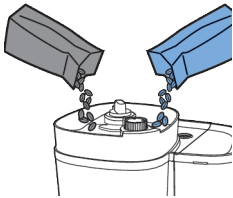

- 7 Închide capacul recipientului pentru boabe de cafea.

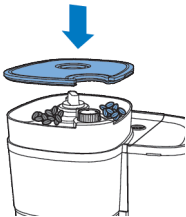

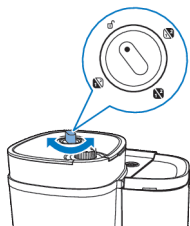

- 8** Rotește butonul de selectare a recipientului pentru a alege boabele de cafea dorite, dintre cele două recipiente.
- Poți chiar să amesteci două tipuri diferite de boabe, pentru un amestec unic.

Notă: Când treci de la un recipient la altul sau când schimbi boabele de cafea, vor rămâne întotdeauna urme de cafea rămase de la tipul de boabe de cafea măcinat anterior. Curăță pâlnia râșniței după ce treci la un nou tip de boabe de cafea, pentru a preveni acest lucru.

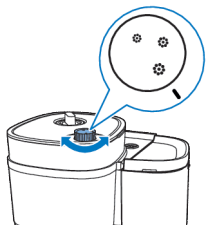

- 9** Alege nivelul de granulație dorit folosind butonul.

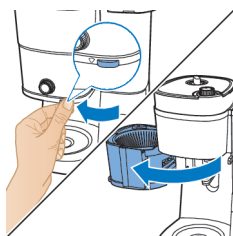

- 10** Prinde urechea pentru a deschide suportul de filtru.

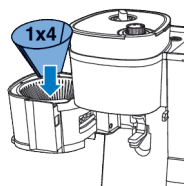

- 11** Pune un filtru din hârtie (tip 1x4 sau nr. 4) în coșul filtrului.

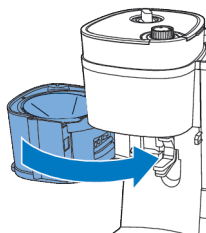

- 12** Închide suportul de filtru.

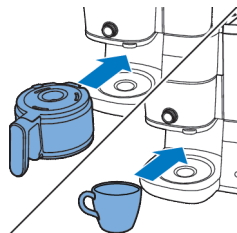

13 Pune cana de cafea sau ceașca sub dozator.

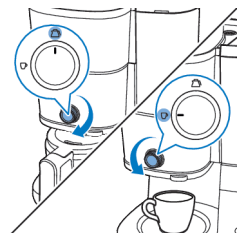

14 Folosește butonul pentru a selecta cantitatea de cafea pe care vrei să o prepari.

Când folosești funcția de preparare în ceașcă, poți folosi cești din sticlă sau ceramică, precum și pahare. Ai grijă să folosești cești cu o înălțime mai mică de 10 cm.

10 3



15 Pornește aparatul.

1 3



16 Selectează numărul de cești pe care vrei să le prepari, apăsând butonul pentru ceașcă.

1 2



17 Apasă butonul pentru tărie pentru a alege tăria preferată a cafelei.

- 1: boabă pentru cafea slabă
- 2: boabe pentru cafea de tărie medie
- 3: boabe pentru cafea tare



18 Începe procesul apăsând butonul start/pauză.

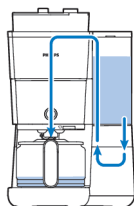

19 Aparatul începe procesarea.

- Aparatul va emite un sunet când este gata.

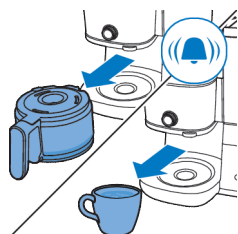

20 Ia ceașca sau cana de cafea din aparat.

Funcția de oprire a picurării îți permite să scoți cana din cafetieră înainte de finalizarea procesului de preparare. Când scoți cana, opritorul de picurare oprește curgerea cafelei în cană.

Procesul de preparare nu se oprește când scoți cana. Dacă nu pui cana la loc în aparat în decurs de 20 de secunde, coșul filtrului se revarsă.



21 Bucură-te de cafeaua ta proaspăt preparată.



22 Pentru a opri aparatul, apasă și menține apăsat butonul start/pauză timp de trei secunde.

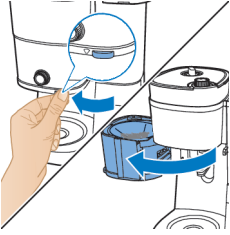

23 Deschide suportul de filtru.

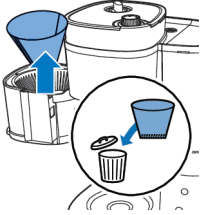

24 Scoate filtrul din hârtie folosit.

Funcția de păstrare la cald nu se activează atunci când prepari una sau două cești.

Aparatul îți va păsata băutura la cald până când se oprește automat. Dacă nu vrei ca băutura să mai fie păstrată la cald, apasă butonul de pornire/oprire pentru a opri aparatul.

Utilizarea cafelei premăcinată

Urmează pașii de mai jos pentru utilizare:

- 1** Verifică dacă aparatul are suficientă apă pentru a prepara cantitatea dorită de cafea.

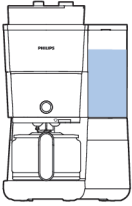

- 2** Prinde urechea pentru a deschide suportul de filtru.

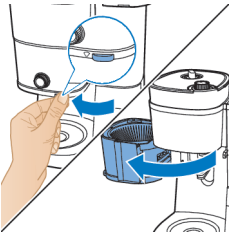

- 3** Pune un filtru din hârtie (tip 1x4 sau nr. 4) în coșul filtrului.

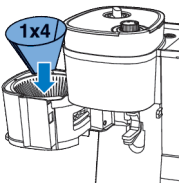

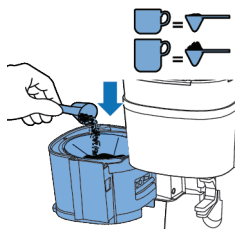

- 4 Adaugă cantitatea de cafea premăcinată pe care o folosești în filtrul din hârtie, în funcție de preferințe.
- Pentru o ceașcă de cafea standard, folosește 6 grame de cafea măcinată sau 1 lingură.

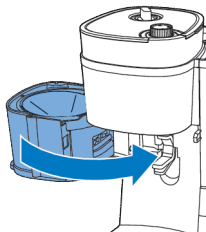

- 5 Închide suportul de filtru.

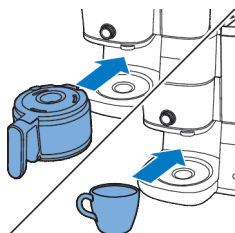

- 6 Pune cana de cafea sau ceașca sub dozator.

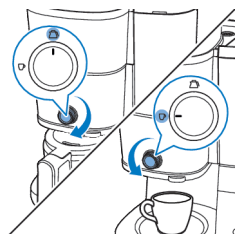

- 7 Folosește butonul pentru a selecta cantitatea de cafea pe care vrei să o prepari.

WS 10 3

- 8 Pornește aparatul.





- 9** Alege utilizarea cafelei premăcinate prin apăsarea butonului de selectare a modului.

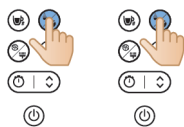

- 10** Selectează numărul de cești pe care vrei să le prepari, apăsând butonul pentru ceașcă.

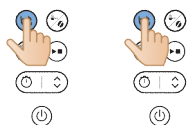

- 11** Începe procesul apăsând butonul start/pauză.



- 12** Aparatul începe procesarea.
- Aparatul va emite un sunet când este gata.

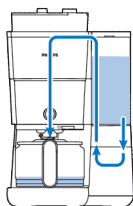

- 13** Ia ceașca sau cana de cafea din aparat.

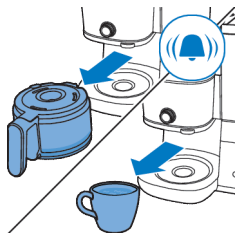



14 Bucură-te de cafeaua ta proaspăt preparată.



15 Pentru a opri aparatul, apasă și menține apăsat butonul start/pauză timp de trei secunde.

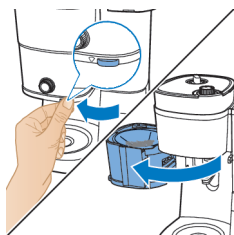

16 Deschide suportul de filtru.

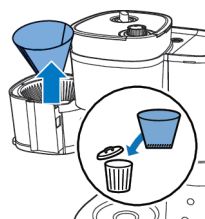

17 Scoate filtrul din hârtie folosit.

Setarea temporizatorului

Pentru a seta temporizatorul la aparat, urmează acești pași:

1 Pornește cafetiera.

08:05



- 2 Apasă butonul de temporizare și pictograma temporizatorului va apărea pe afișaj. Cifrele orei luminează intermitent pentru a indica setarea orelor.

08:00



- 3 Folosește butonul săgeată pentru a regla orele. Dacă vrei să reglezi rapid, apasă lung butonul săgeată.

08:



- 4 Apasă butonul de temporizare pentru a confirma setarea orelor. Cifrele minutelor indică setarea minutelor.

08:05



- 5 Folosește butonul săgeată din nou pentru a regla minutele. Dacă vrei să reglezi rapid, apasă lung butonul săgeată.

08:05



- 6 Apasă din nou butonul de temporizare pentru a confirma setarea minutelor.
Pentru a anula temporizatorul, apasă butonul de temporizare și pictograma temporizatorului va dispărea de pe afișaj.

Funcția de oprire a picurării îți permite să scoți cana din cafetieră înainte de finalizarea procesului de preparare. Când scoți cana, opritorul de picurare oprește curgerea cafelei în cană.

Notă: Procesul de preparare nu se oprește când scoți cana. Dacă nu pui cana la loc în aparat în decurs de 20 de secunde, coșul filtrului se revarsă.

Curățare și întreținere

Curățarea după fiecare utilizare

Nu introdu cafetiera în apă sau în alt lichid și nici nu-l clăți sub jet de apă.

- 1 Scoate ștecherul din priza de perete.

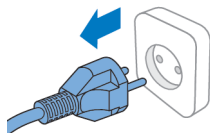









- 2 Șterge exteriorul cafetierei cu o cârpă umedă.
- 3 Curăță coșul filtrului cu apă caldă și detergent lichid sau curăță-l în mașina de spălat vase.



- 4 Curăță cana pentru cafea și capacul sub jet de apă. Sau curăță-le în mașina de spălat vase.

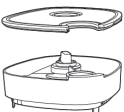

			
	✓	✓	✓
	✓	✓	✓
	✓	✓	✓
	✓	✗	✓
	✓	✗	✓

Curățarea pâlniei râșniței

Important:

Curăță pâlnia râșniței la fiecare 1-2 săptămâni pentru a preveni înfundarea cu cafea măcinată. Poți face acest lucru ușor și rapid urmând pașii de mai jos.

Curăță pâlnia râșniței când observi că a apărut alerta de perie pe afișaj.

Notă: Ai grijă ca recipientul pentru boabe de cafea să fie gol înainte de a începe procedura de curățare.

1 Conectează aparatul.

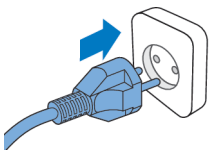

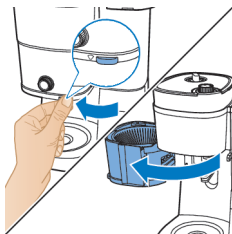

2 Deschide suportul de filtru pentru a accesa canalul pâlniei pentru cafea măcinată.

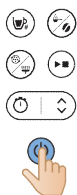

3 Pornește cafetiera.

4 Apasă butonul de curățare de pe panoul de control al aparatului.

5 Selectează setarea pentru perie pe afișaj.



6 Apasă butonul de start. Acest lucru va deschide clapeta canalului pâlniei pentru cafea măcinată, permițându-ți să cureți canalul cu o perie.

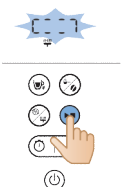

7 Folosește o perie pentru a îndepărta orice urme de cafea măcinată sau reziduuri care s-au acumulat în canal.

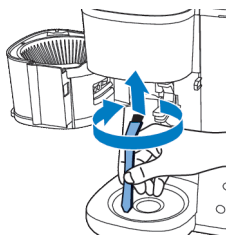



- 8 După curățarea canalului, apasă din nou butonul de start pentru a închide clapeta.

Detartrarea cafetierei

Detartrează cafetiera când observi că a apărut alerta de detartrare pe afișaj. Folosește doar oțet alb pentru detartrare, deoarece alte produse pot deteriora cafetiera.

Avertisment: Nu folosi niciodată oțet cu un conținut de acid acetic de 8 % sau mai mult, oțet natural, detartrant sub formă de pudră sau detartrant sub formă de tabletă pentru a detartra aparatul, deoarece acest lucru poate cauza deteriorare.

- 1 Deschide capacul rezervorului de apă.

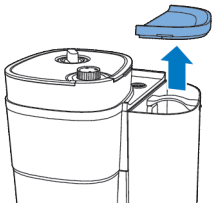

- 2 UMLE rezervorul de apă cu oțet alb (4% acid acetic) până la marcajul pentru 10 cești.

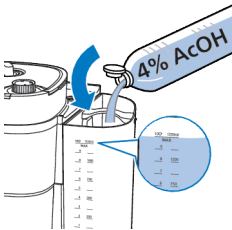

3 Închide capacul recipientului pentru apă.

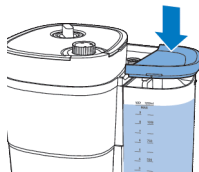

4 Prinde urechea pentru a deschide suportul de filtru.

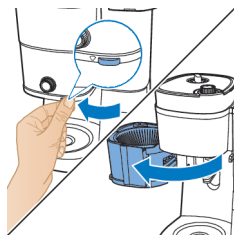

5 Pune un filtru din hârtie (tip 1x4 sau nr. 4) în coșul filtrului și închide suportul filtrului.

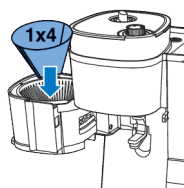

6 Pune cana pentru cafea goală în cafetieră.

7 Introdu ștecherul în priză.

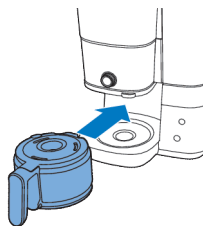

8 Apasă butonul de alimentare pentru a porni cafetiera. Afișajul se aprinde.

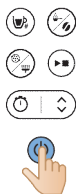

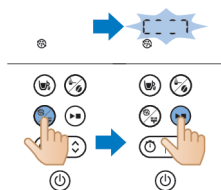

- 9** Apasă butonul de curățare de pe cafetieră.
- 10** Selectează setarea de detartrare.
- 11** Apasă butonul de start pentru a confirma selecția.
- Cafetiera va începe automat procesul de detartrare.

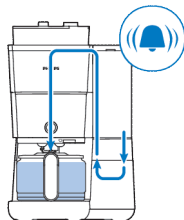

- 12** Așteaptă ca aparatul să termine de preparat soluția de detartrare.
- 13** După terminarea procesului de detartrare, clătește de două ori aparatul cu cantitatea maximă de apă pentru a îndepărta complet orice depuneri.

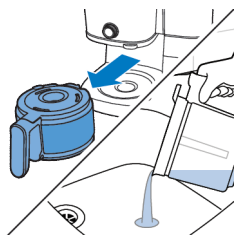

- 14** Golește cana și scoate filtrul din hârtie cu reziduurile de calcar.
- 15** Umple rezervorul de apă cu apă rece curată și apasă butonul de start pentru a începe un alt proces de preparare.
- Lasă cafetiera să finalizeze întregul proces de preparare și golește cana.

Notă: Dacă este necesar, repetă pasul 14 până când apa care iese din cafetieră nu mai are gust și miros de oțet.

- 16** Curăță coșul filtrului și cana cu apă caldă și puțin detergent lichid.
- 17** Apasă butonul de alimentare pentru a opri aparatul.

Depanare

Acest capitol descrie cele mai frecvente probleme pe care le poți avea la utilizarea aparatului. Dacă nu poți rezolva problema cu ajutorul informațiilor de mai jos, accesează www.philips.com/support, unde vei găsi o listă de întrebări frecvente, sau contactează Centrul de asistență pentru clienți din țara ta. Poți scana acest cod QR pentru asistență online suplimentară.



Problemă

Cafetiera nu funcționează.

Soluție

Introdu ștecherul de alimentare într-o priză de perete și apasă butonul de pornire/oprire pentru a porni cafetiera.

Asigură-te că tensiunea indicată pe cafetieră corespunde tensiunii rețelei locale.

Umple rezervorul cu apă.

Închide capacul pâlniei râșniței.

Râșnița nu funcționează sau nu funcționează corespunzător.

Asigură-te că nu ai selectat cafea premăcinată. Dacă simbolul pentru cafea premăcinată este vizibil pe afișaj, ai selectat cafeaua premăcinată.

Curăță pâlnia râșniței urmând instrucțiunile.

Când folosesc râșnița, cafeaua este prea slabă.

Rotește butonul de granulație pentru a selecta tipul dorit de măcinare, de la fină până la grosieră.

Folosește butonul de selectare a tăriei pentru a seta tăria cafelei de la 1 la 3, unde numărul mai mare înseamnă cafea mai tare.

Folosește boabe de cafea de amestec sau aromă mai tare.

Când folosesc cafea premăcinată, cafeaua este prea slabă.

Asigură-te că cantitatea de cafea premăcinată din filtru este în concordanță cu cantitatea de apă din rezervorul de apă. Te rugăm să reții că aparatul folosește toată apa din rezervorul de apă.

Folosește cafea măcinată de amestec sau aromă mai tare.

Pentru a crește tăria cafelei, crește cantitatea de cafea premăcinată sau micșorează cantitatea de apă.

Filtrul se revarsă când scot cana din cafetieră în timp ce prepară cafea.

Dacă ții cana scoasă mai mult de 20 de secunde în timpul procesului de preparare, opritorul de picurare face să se reverse coșul filtrului. Ține cont și de faptul că cafeaua nu atinge gustul deplin înainte de încheierea procesului de preparare. Prin urmare, te sfătuim să nu scoți cana pentru a-ți turna cafea înainte de încheierea procesului de preparare.

Cafetiera continuă să picure mult timp după încheierea procesului de preparare.

Picurarea este cauzată de condensarea aburului. Este complet normal să picure cafetiera o perioadă de timp.

Nu poți aștepta ultimele picături?

Comută butonul de la modul ceașcă la modul cană pentru a activa funcția de oprire a picurării, iar aceasta va opri picurarea de la coșul filtrului.

Dacă picurarea nu se oprește, este posibil ca opritorul să fie înfundat. Pentru a curăța opritorul de picurare, deschide suportul pentru coșului filtrului și scoate coșul filtrului. Clătește coșul filtrului și opritorul de picurare sub jet de apă.

Cafeaua nu este suficient de fierbinte.

Cafeaua din cană se răcește mai repede dacă prepari doar câteva cești. Cafeaua rămâne fierbinte mai mult timp dacă prepari 10 cești, adică o cană plină.

Detartrează cafetiera.

Boabele de cafea par să se consume rapid.

Pentru a prepara o ceașcă de cafea perfectă, cafetiera necesită o anumită cantitate de cafea măcinată. Cantitatea de boabe de cafea pe care o folosește cafetiera pentru a obține cantitatea optimă de cafea măcinată per ceașcă este normală.

Temporizatorul nu funcționează.

Asigură-te că ai parcurs toți pașii pentru prepararea cafelei cu boabe de cafea sau cafea premăcinată înainte de a seta temporizatorul.

Cod de eroare

Cod de eroare	Descriere	Soluție	Observație
E1	Lipsă apă	Apasă orice buton pentru a trece aparatul în modul standby. Reumple rezervorul de apă și repornește aparatul.	Dacă problemă persistă, urmează acești pași: Apasă și menține apăsat simultan butoanele de curățare și de start timp de trei secunde, până când aparatul începe automat să pompeze apă timp de un minut. Repetă acest proces de 3 ori. Contactează serviciul pentru clienți dacă problema persistă.
E2	Recipient pentru boabe de cafea indisponibil	Apasă orice buton pentru a trece aparatul în modul standby. Atașează ferm recipientul pentru boabe de cafea și repornește aparatul.	Contactează serviciul pentru clienți dacă problema persistă.
E3	Defecțiune la tubul de încălzire	Scoate aparatul din priză. Introdu aparatul în priză și pornește-l din nou după ce s-a răcit complet.	Contactează serviciul pentru clienți dacă problema persistă.
E4	Blocaj la roata râșniței	Scoate aparatul din priză. Introdu aparatul în priză și repornește-l. Urmează pașii de la „Curățarea pâlniei râșniței” pentru a curăța roata râșniței și canalul pâlniei pentru cafea măcinată.	Contactează serviciul pentru clienți dacă problema persistă.
E5	Blocaj la canalul pâlniei pentru cafea măcinată	Scoate aparatul din priză. Introdu aparatul în priză și repornește-l. Urmează pașii de la „Curățarea pâlniei râșniței” pentru a curăța canalul pâlniei pentru cafea măcinată.	Contactează serviciul pentru clienți dacă problema persistă.
E6/E7/ E8	Eroare de program	Scoate aparatul din priză. Introdu aparatul în priză și repornește-l.	Contactează serviciul pentru clienți dacă problema persistă.

Johdanto

Onnittelut ostoksestasi ja tervetuloa Philips-tuotteen käyttäjäksi!
Hyödynnä Philipsin tukipalveluita rekisteröimällä tuotteesi osoitteessa
www.Philips.com/welcome.

Yleiskuvaus

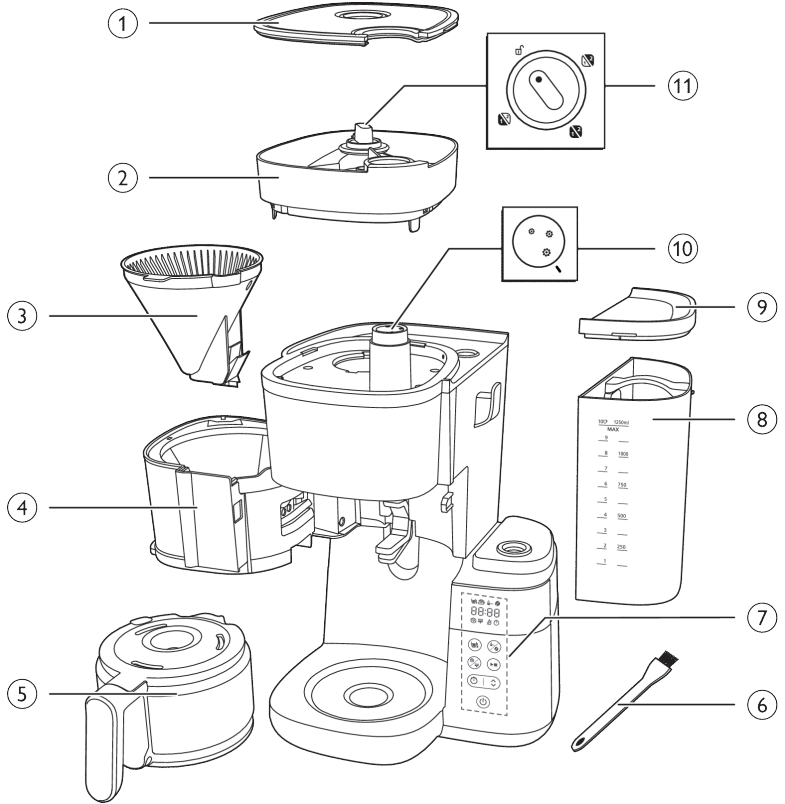

- 1 Papisäiliön kansi
- 2 Papisäiliö
- 3 Suodatinkori
- 4 Suodatinkorin teline
- 5 Lasikannu
- 6 Papukuilun puhdistusharja
- 7 Ohjauspaneeli, jossa on näyttö
- 8 Vesisäiliö
- 9 Vesisäiliön kansi
- 10 Jauhatuksen säätönappi
- 11 Säiliönvalitsimen nappi

Ohjauspaneeli



Virtapainike



Ajastinpainike ja ajansäädön nuolipainike



Käynnistyspainike



Puhdistuspainike



Kahvijauheen ja kahvin vahvuuden painike



Kupin valintapainike

Näytön kuvake



Kuppien määrä



Lämpimänäpito toiminto



Kahvijauhe



Kahvin vahvuus



Kalkinpoisto



Manuaalisen puhdistuksen hälytys



Vesisäiliön vesi vähissä



Ajastin



Kellonajan näyttö

Kaksi ensimmäistä numeroa ilmaisevat tunnit ja kaksi viimeistä numeroa ilmaisevat minuutit.



Kierrä nuppi lukitsemattomaan asentoon, jotta voit irrottaa papusäiliön laitteesta.



Tällä nupilla valitaan jauhatus, ja suurempi koko tarkoittaa karkeampaa jauhatusta.



Kannutila

Tippalukko toimii kannutilassa.

Huomautus: Suodatus ei keskeydy, kun otat kannun pois. Jos et laita kannua takaisin laitteeseen 20 sekunnin kuluessa, kahvi valuu suodatinkorista yli.



Kuppitila

Käännä nuppi manuaalisesti kuppitilasta kannutilaan, jotta tippalukko estää tippumisen, kun suodatus on valmis

Huomautus: Kylmä keraaminen muki viilentää lämmitessään kahvia, joten esilämmitä kuppi kuumalla vedellä.

Tärkeää

Varoitus

- Tarkista, että laitteeseen merkitty käyttöjännite vastaa paikallista verkkojännitettä, ennen kuin liität laitteen pistorasiaan.
- Liitä laite maadoitettuun pistorasiaan.
- Älä käytä laitetta, jos pistoke, johto tai itse laite on vaurioitunut.
- Jos virtajohto on vahingoittunut, vaihdata se oman turvallisuutesi vuoksi Philipsin valtuuttamassa huoltoliikkeessä tai muulla ammattitaitoisella korjaajalla.
- Laitetta voivat käyttää myös yli 8-vuotiaat lapset ja henkilöt, joiden fyysinen tai henkinen toimintakyky on rajoittunut tai joilla ei ole kokemusta tai tietoa laitteen käytöstä, jos heitä on neuvottu laitteen turvallisesta käytöstä tai tarjolla on turvallisen käytön edellyttämä valvonta ja jos he ymmärtävät laitteeseen liittyvät vaarat. Yli 8-vuotiaat lapset voivat puhdistaa tai huoltaa laitetta valvonnan alaisena. Pidä laite ja sen johto alle 8-vuotiaiden lasten ulottumattomissa.
- Lasten ei saa antaa leikkiä laitteella.
- Älä jätä virtajohtoa roikkumaan sen pöydän tai työtason reunan yli, jonka päällä laite on.
- Käytä tätä laitetta ainoastaan sen asianmukaiseen tarkoitukseen, jotta vältät mahdolliset vaarat tai vammat.

Varoitus

- Huuhtele laite puhtaalla vedellä ennen käyttöönottoa.
- Älä aseta laitetta kuumalle alustalle ja pidä huoli, ettei virtajohto kosketa mitään kuumaa pintaa.
- Älä laita laitetta kaappiin käytön aikana.
- Irrota pistoke pistorasiasta ennen laitteen puhdistamista tai jos suodattamisen aikana on ilmennyt ongelmia.
- Puhdista laite aina, kun se on jäähtynyt.
- Vesisäiliö, suodatinteline, lämpölevy, laitteen alaosa ja täynnä kahvia oleva kannu kuumenevat kahvin keittämisen ja lämpimänäpidon aikana ja pysyvät kuumina jonkin aikaa.
- Älä lämmitä kahvia kannussa uudelleen liedellä tai mikroaaltouunissa.
- Laite on tarkoitettu käytettäväksi kotitalouksissa ja esimerkiksi henkilökuntaruokaloissa, toimistoissa ja muissa työ- ja asuinympäristöissä, kuten maatilamajoituksessa, aamiaismajoituksessa, hotelleissa ja motelleissa.
- Toimita laite vianmääritystä ja korjaamista varten Philipsin valtuuttamaan huoltoliikkeeseen. Älä avaa laitetta tai yritä korjata sitä itse.
- Lämmitysvastus, suodatinteline, laitteen alaosa, lämpölevy ja täynnä kahvia oleva kannu ovat kuumia vielä jonkin aikaa käytön jälkeen.
- Kaikki pakkausmateriaalit on valmistettu kierrätetystä paperista, ellei toisin ilmaista. Katso pakkauksen PAP-merkintä.

Kalkinpoisto

- Poista kahvinkeittimestä kalkki, kun näytössä näkyy kalkinpoistohälytys. Käytä kalkinpoistossa vain ruokaetikkaa, sillä muut tuotteet saattavat vahingoittaa laitetta.

Sähkömagneettiset kentät (EMF)

Tämä Philips-laite vastaa sähkömagneettisia kenttiä (EMF) koskevia standardeja.

Kierrätys



Tämä merkki tarkoittaa, että tätä tuotetta ei saa hävittää tavallisen kotitalousjätteen mukana (2012/19/EU).

Noudata maasi sähkö- ja elektroniikkalaitteiden erillistä keräystä koskevia sääntöjä. Asianmukainen hävittäminen auttaa ehkäisemään ympäristölle ja ihmisille mahdollisesti koituvia haittavaikutuksia.

Kaikki pakkausmateriaalit on valmistettu kierrätetystä paperista, ellei toisin ilmaista. Katso pakkauksen PAP-merkintä.

Takuu ja tuki

Versuni myöntää tälle tuotteelle kahden vuoden takuun. Takuu ei ole voimassa, jos vika johtuu virheellisestä käytöstä tai puutteellisesta ylläpidosta. Takuumme ei vaikuta lakisääteisiin oikeuksiisi kuluttajana. Lisätietoja takuusta sekä ohjeet takuuseen vetoamiseksi ovat osoitteessa www.philips.com/support.

Ennen käyttöönottoa

Puhdista suodatinteline ja kesto-suodatin jokaisen käyttökerran jälkeen.

Pyyhi suodatinteline perusteellisesti kuivalla liinalla jokaisen käyttökerran jälkeen. Pyyhi pois mahdolliset kertymät.

Kellonajan asettaminen

- 1 Työnnä pistoke pistorasiaan.
 - Tuntien ilmaisin alkaa vilkkua.

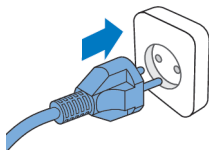

08:00



- 2 Säädä tunteja nuolipainikkeella.

08:



- 3 Kun tunnit on asetettu, vahvista asetetus painamalla ajastinpainiketta.



08:05



- 4 Minuuttien ilmaisin alkaa vilkkua. Säädä minuutteja nuolipainikkeella.

08:06



08:06

5 Vahvista minuutit painamalla ajastinpainiketta.

- Nykyinen kellonaika on nyt asetettu ja tallennettu.
- 6 Voit säätää ajastinta valmiustilassa kahdella tavalla:
 - Irrota laitteen pistoke pistorasiasta ja kytke se takaisin.
 - Pidä ajastinpainiketta painettuna, kunnes tuntien numerot alkavat vilkkua.

Huomautus

Laite tallentaa aina viimeisimmän asetuksen.

Lämpimänäpitoaika

Voit valita, kuinka kauan kahvis pysyy kuumana, säätämällä automaattisen sammutuksen ajankohtaa. Automaattisen sammutusajan oletusasetus on 30 minuuttia. Automaattisen sammutusajan enimmäisasetus on 300 minuuttia.

Voit säätää automaattista sammutusaikaa seuraavasti:

- 1 Katkaise laitteesta virta ja jätä pistoke pistorasiaan.
- 2 Pidä puhdistuspainiketta painettuna, kunnes lämpimänäpitoaika tulee näkyviin ja tuntien numerot alkavat vilkkua.
- 3 Viimeistele asetukset noudattamalla Kellonajan asettaminen -kohdan vaiheita.

Laitteen huuhtelu

Huuhtele kahvinkeitin aina ennen ensimmäistä käyttöä noudattamalla seuraavia ohjeita.

Varoitus: Älä koskaan kaada vettä kahvipapusailiöön, sillä tämä vahingoittaa kahvinkeitintä.

- 1 Avaa vesisäiliön kansi.

Varoitus: Älä laita kahvipapuja tai kahvijauhetta vesisäiliöön.

- 2 Voit täyttää vesisäiliön vedellä jommallakummalla seuraavista tavoista:

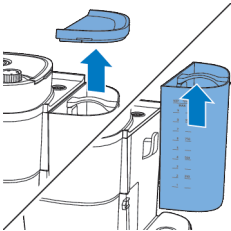



- Nosta säiliö laitteesta, laita se vesihanalle ja täytä se vedellä.

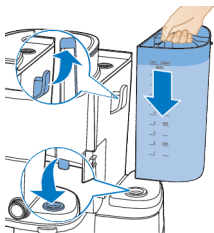

- Varmista, että kiinnität koukun kunnolla, kun asetat säiliön takaisin paikalleen.
- Nosta kannun kantta kannen läpän avulla. Laita kahvikannu vesihanalle ja täytä se vedellä. Täytä vesisäiliö kahvikannulla.
- Varmista, että vettä on enintään enimmäistasomerkkiin asti.

3 Sulje vesisäiliön kansi.

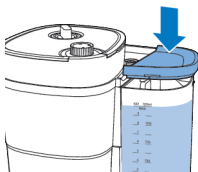

4 Aseta kahvikannu laitteeseen.

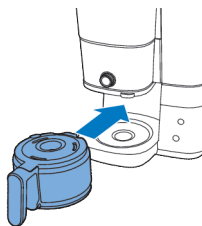

5 Kierrä valitsin kannuasentoon.

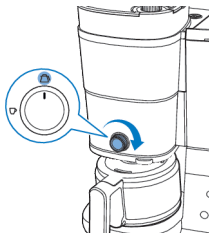

10 3



- 6** Paina käynnistyspainiketta.
- Laitteeseen kytketään virta.

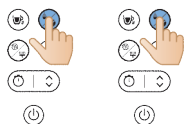

- 7** Paina kahvin vahvuuden painiketta ja valitse kahvijauhe.

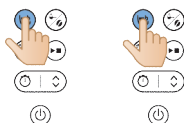

- 8** Paina kuppipainiketta ja valitse 10 kuppia.



- 9** Paina käynnistyspainiketta.

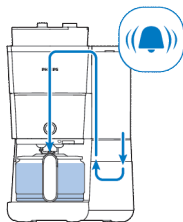

- 10** Laite käynnistää huuhtelun.
11 Anna laitteen käydä, kunnes huuhtelu on päättynyt.



12 Tyhjennä lasikannu.

Käyttö

Kahvipapujen käyttö

Huomautus: Kahvinkeitin käyttää tarvittavan määrän vettä valmistettavien kupillisten määrän perusteella.

Käytä seuraavasti:

1 Avaa vesisäiliön kansi ja nosta säiliö laitteesta.

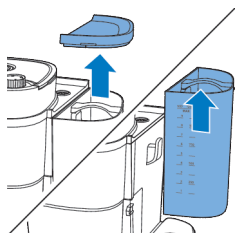

2 Täytä säiliö vesihanasta.

- Varmista, että vettä on enintään enimmäistasomerkkiin asti.



3 Aseta säiliö takaisin laitteeseen.

- Varmista, että koukku on kiinnitetty kunnolla.

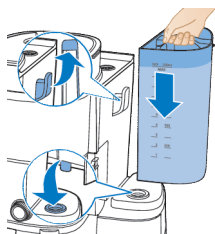

4 Sulje vesisäiliön kansi.

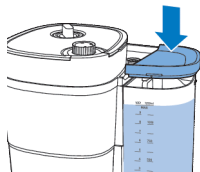

5 Avaa kahvipapusäiliön kansi.

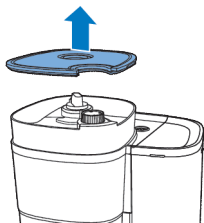

6 Lisää kahvipavut säiliöön.

Huomautus: Varmista aina, että tuoreiden kahvipapujen kaksoisäiliö on ainakin puolillaan.

Varoitus: Älä käytä paahtamatonta kahvia tai sokeroituja papuja, jotta kahvimylly ei jumiudu. Käytä kahvipapuja espressopapujen sijaan, sillä espressopavut saattavat vahingoittaa myllyä.

7 Sulje kahvipapusäiliön kansi.

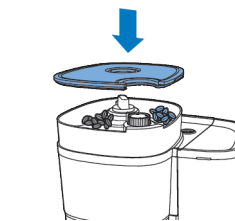

8 Valitse haluttujen papujen säiliö kiertämällä säiliönvalitsimen nuppia.

- Voit myös sekoittaa kahdenlaisia papuja, jotta saat ainutlaatuisen sekoituksen.

Huomautus: Kahvipapusäiliötä tai kahvipapulajia vaihdettaessa keittimeen jää aina hieman edellistä kahvijauhetta, joka voi vaikuttaa kahvin makuun. Voit välttää makujen sekoittumisen puhdistamalla myllyn suppilon aina, kun käytät uudentyypisiä kahvipapuja.

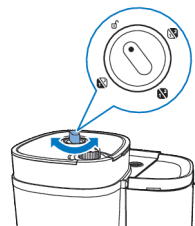

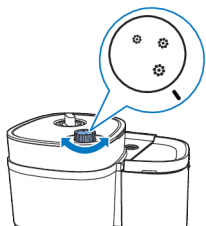

9 Valitse jauhatus käyttämällä nuppia.

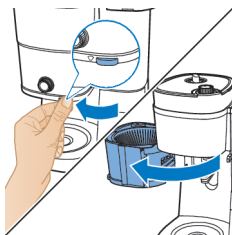

10 Avaa suodatinteline läpän avulla.

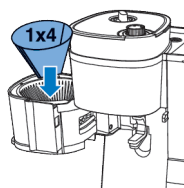

11 Laita suodatinpaperi (kokoa 1x4 tai nro 4) suodatinkoriin.

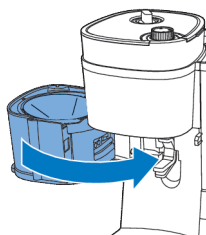

12 Sulje suodatinteline.

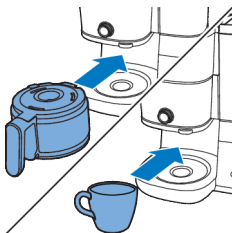

13 Aseta kahvikannu tai kuppi annostelijan alle.

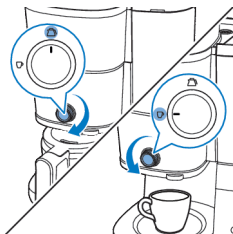

14 Valitse keitettävä kahvimäärä nupin avulla.

Kun valmistat kahvin suoraan kuppiin, voit käyttää lasisia tai keraamisia mukeja sekä laseja. Varmista, että kuppien korkeus on alle 10 cm.

☕ 3
10 3



15 Kytke laitteeseen virta.

☕ 3
1 3



16 Valitse keitettävä kuppimäärä painamalla kuppipainiketta.

☕ 3
1 2



17 Valitse kahvin vahvuus painamalla vahvuuden painiketta.

- 1: pavut miettoon kahviin
- 2: pavut keskivahvaan kahviin
- 3: pavut vahvaan kahviin

☕ 3
[=]



18 Käynnistä valmistus painamalla käynnistypainiketta.

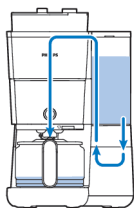

19 Laite käynnistää valmistuksen.

- Laitteesta kuuluu merkkiääni, kun se on valmis.

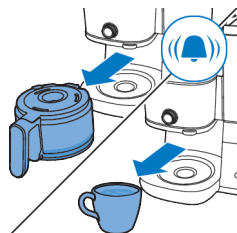

20 Poista kuppi tai kahvikannu laitteesta.

Tippalukon ansiosta voit ottaa kannun kahvinkeitimestä ennen kuin suodatus on valmis. Kun otat kannun, tippalukko estää kahvia valumasta.

Suodatus ei keskeydy, kun otat kannun pois. Jos et laita kannua takaisin laitteeseen 20 sekunnin kuluessa, kahvi valuu suodatinkorista yli.



21 Nauti vastakeitetyistä kahvista.



22 Sammuta laite pitämällä käynnistyspainiketta painettuna kolmen sekunnin ajan.

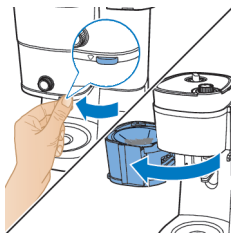

23 Avaa suodatinteline.

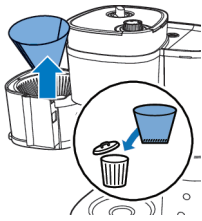

24 Poista käytetty suodatinpaperi.

Lämpimänäpitotoiminto ei käynnisty, jos valmistat yhden kupillisen tai kaksi kupillista.

Laite pitää juoman kuumana, kunnes se sammuu automaattisesti. Jos et halua juoman pysyvän enää kuumana, sammuta laite painamalla virtapainiketta.

Valmiiksi jauhetun kahvin käyttö

Käytä seuraavasti:

1 Tarkista, että laitteessa on riittävästi vettä halutun kahvimäärän keittämiseen.

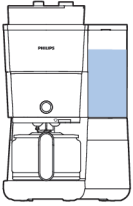

2 Avaa suodatinteline läpän avulla.

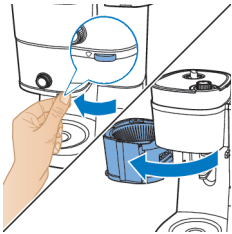

3 Laita suodatinpaperi (kokoa 1x4 tai nro 4) suodatinkoriin.

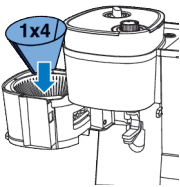

4 Annostele suodatinpaperiin sopiva määrä kahvijauhetta mieltymystesi mukaisesti.

- Käytä tavallista kahvikupillista varten 6 grammaa tai 1 ruokalusikallinen kahvijauhetta.

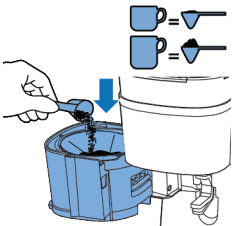

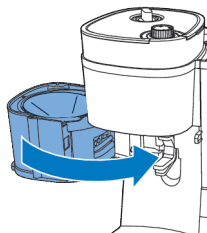

5 Sulje suodatinteline.

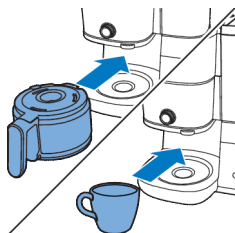

6 Aseta kahvikannu tai kuppi annostelijan alle.

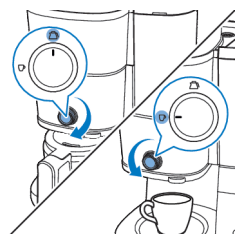

7 Valitse keitettävä kahvimäärä nupin avulla.

10 3

8 Kytke laitteeseen virta.



9 Valitse kahvijauheen käyttö painamalla tilanvalintapainiketta.

10 3 → 10 3

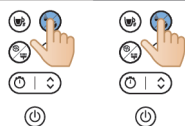



10 Valitse keitettävä kuppimäärä painamalla kuppipainiketta.

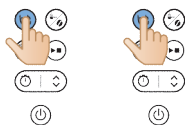

11 Käynnistä valmistus painamalla käynnistyspainiketta.



12 Laite käynnistää valmistuksen.

- Laitteesta kuuluu merkkiäni, kun se on valmis.

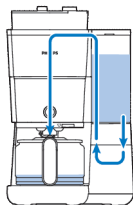

13 Poista kuppi tai kahvikannu laitteesta.

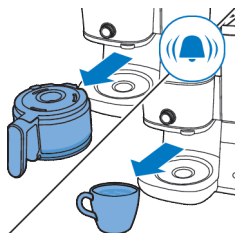

14 Nauti vastakeitetystä kahvista.



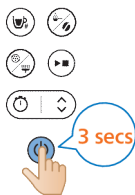

15 Sammuta laite pitämällä käynnistypainiketta painettuna kolmen sekunnin ajan.

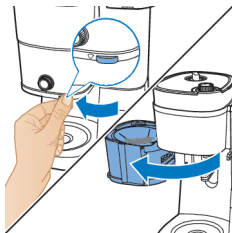

16 Avaa suodatinteline.

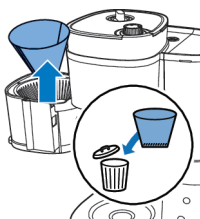

17 Poista käytetty suodatinpaperi.

Ajastimen asettaminen

Aseta laitteen ajastin seuraavasti:

- 1** Käynnistä kahvinkeitin.
- 2** Paina ajastinpainiketta, ja ajastinkuvake tulee näyttöön. Tuntien numerot vilkkuvat, jotta voit asettaa tunnit.

08:06



08:00



- 3 Säädä tunteja nuolipainikkeella. Jos säätö on tehtävä nopeasti, paina nuolipainiketta pitkään.

08:



- 4 Vahvista tuntien asetus painamalla ajastinpainiketta. Minuuttien numerot ilmaisevat, että voit asettaa minuutit.



08:05



- 5 Säädä myös minuutteja nuolipainikkeella. Jos säätö on tehtävä nopeasti, paina nuolipainiketta pitkään.

08:05



- 6 Vahvista minuuttien asetus painamalla ajastinpainiketta.

Voit peruuttaa ajastimen painamalla ajastinpainiketta, ja ajastinkuvake poistuu näytöstä.

Tippalukon ansiosta voit ottaa kannun kahvinkeitimestä ennen kuin suodatus on valmis. Kun otat kannun, tippalukko estää kahvia valumasta.

Huomautus: Suodatus ei keskeydy, kun otat kannun pois. Jos et laita kannua takaisin laitteeseen 20 sekunnin kuluessa, kahvi valuu suodatinkorista yli.

Puhdistus ja hoito

Laitteen puhdistus jokaisen käytön jälkeen

Älä upota kahvinkeitintä veteen tai muuhun nesteeseen. Älä myöskään huuhtelee sitä vesihanan alla.

1 Irrota pistoke pistorasiasta.

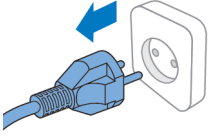









2 Pyyhi kahvinkeitin ulkopinta kostealla liinalla.

3 Puhdista suodatinkori kuumalla vedellä ja tiskiaineella tai pese se astianpesukoneessa.



4 Puhdista kahvikannu ja kansi ja huuhtele ne vesihanalla. Voit myös pestä ne astianpesukoneessa.

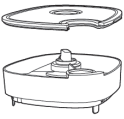

			
	✓	✓	✓
	✓	✓	✓
	✓	✓	✓
	✓	✗	✓
	✓	✗	✓

Myllyn suppilon puhdistaminen

Tärkeää:

Puhdista myllyn suppilo 1–2 viikon välein, jotta kahvijauhe ei tuki sitä. Sen voi tehdä helposti ja nopeasti noudattamalla alla olevia ohjeita.

Puhdista myllyn suppilo, kun näytössä näkyy hälytys, jossa on harjasymboli.

Huomautus: Varmista, että kahvipapusailiö on tyhjä, ennen kuin aloitat puhdistuksen.

1 Työnnä pistoke pistorasiaan.

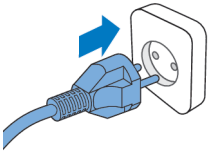

2 Avaa suodatinteline, jotta näet kahvijauhesuppilon kuilun.

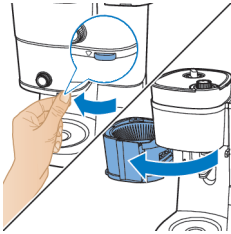

3 Käynnistä kahvinkeitin.

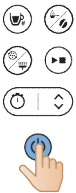

4 Paina keittimen ohjauspaneelin puhdistuspainiketta.

5 Valitse näytössä harja-asetus.





- 6 Paina käynnistyspainiketta. Kahvijauhesuppilon kuilun läppä avautuu, jotta voit puhdistaa kuilun harjalla.

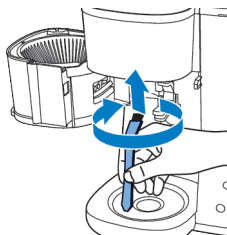

- 7 Poista kuiluun mahdollisesti kertynyt kahvijauhe tai muut jäämät harjalla.



- 8 Kun olet puhdistanut kuilun, sulje läppä painamalla uudelleen käynnistyspainiketta.

Kalkinpoisto kahvinkeittimestä

Poista kahvinkeittimestä kalkki, kun näytössä näkyy kalkinpoistohälytys. Käytä kalkinpoistossa vain ruokaetikkaa, sillä muut tuotteet saattavat vahingoittaa kahvinkeitintä.

Varoitus: Älä koskaan käytä keittimen kalkinpoistoon etikkaa, jonka vahvuus on 8 % tai enemmän, luonnonetikkaa äläkä jauhe- tai tablettikalkinpoistoainetta, koska ne voivat aiheuttaa vaurioita.

- 1 Avaa vesisäiliön kansi.

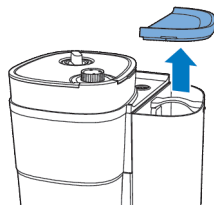

- 2 Lisää vesisäiliöön ruokaetikkaa (4 % etikkaa) 10 kupin merkkiin asti.

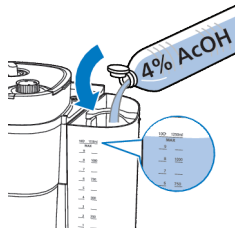

- 3 Sulje vesisäiliön kansi.

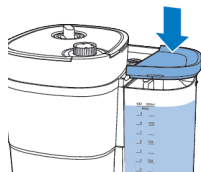

- 4 Avaa suodatinteline läpän avulla.

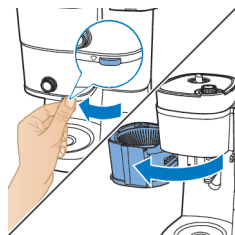

- 5 Aseta suodatinpaperi (koko 1x4 tai nro 4) suodatinkoriin ja sulje suodatinkorin teline.

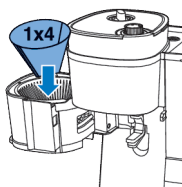

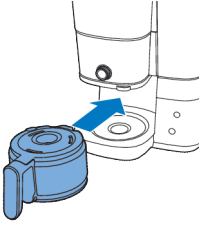

- 6** Aseta tyhjä kannu kahvinkeittimeen.
7 Työnnä pistoke pistorasiaan.

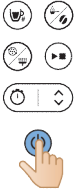

- 8** Käynnistä kahvinkeitin painamalla virtapainiketta. Näytön merkkivalot syttyvät.

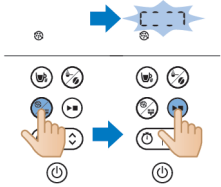

- 9** Paina kahvinkeitimen puhdistuspainiketta.
10 Valitse kalkinpoistoasetus.
11 Vahvista valinta painamalla käynnistyspainiketta.
 - Kahvinkeitin käynnistää kalkinpoiston automaattisesti.

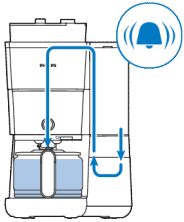

- 12** Odota, että keitin on suodattanut kalkinpoistoaineen.
13 Kun kalkinpoisto on valmis, huuhtele keitin kahdesti enimmäismäärällä vettä, jotta kaikki jäämät poistuvat.

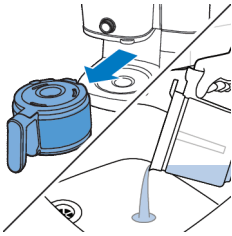

- 14** Tyhjennä kannu ja poista suodatinpaperi, joka on kerännyt kalkkijäämät.
15 Aloita toinen suodatus täyttämällä vesisäiliö puhtaalla kylmällä vedellä ja painamalla käynnistyspainiketta.
 Anna kahvinkeitimen suodattaa koko vesimäärä ja tyhjennä sitten kannu.

Huomautus: Toista vaihe 14 tarvittaessa, kunnes kahvinkeitimestä suodattava vesi ei enää maistu tai haise etikalle.

- 16** Puhdista suodatinkori ja kannu kuumalla vedellä ja muutamalla tipalla astianpesuainetta.
17 Sammu laite painamalla virtapainiketta.

Vianmääritys

Tässä osiossa kuvataan lyhyesti yleisimpiä ongelmia, joita saatat kohdata käyttäessäsi laitetta. Jos et löydä ongelmaasi ratkaisua seuraavista tiedoista, lue osoitteesta www.philips.com/support vastauksia usein kysytyihin kysymyksiin tai ota yhteys paikalliseen kuluttajapalvelukeskukseen. Saat lisätukea verkossa skannaamalla tämän QR-koodin.



Ongelma

Ratkaisu

Kahvinkeitin ei toimi.

Liitä virtapistoke pistorasiaan ja kytke kahvinkeitimen virta painamalla virtapainiketta.

Varmista, että kahvinkeitimen jännitemerkintä vastaa paikallista verkkojännitettä.

Täytä vesisäiliö vedellä.

Sulje myllyn suppilon kansi.

Mylly ei toimi tai se ei toimi oikein.

Varmista, että et valinnut kahvijauhetta. Jos kahvijauheen symboli näkyy näytössä, valitsit kahvijauheen.

Puhdista myllyn suppilo noudattamalla ohjeita.

Kun käytän kahvimyllyä, kahvi on liian mietoa.

Valitse jauhatustyyppi kiertämällä jauhatuksen säätönappia (hienosta karkeaan).

Aseta kahvin vahvuus (1–3) kahvin vahvuuden valintapainikkeella. Suurempi numero tarkoittaa vahvempaa kahvia.

Käytä vahvempia kahvipapuja.

Kun käytän kahvijauhetta, kahvi on liian mietoa.

Varmista, että suodattimeen lisätyn kahvijauheen määrä vastaa vesisäiliössä olevaa vesimäärää. Muista, että kahvinkeitin käyttää kaiken vesisäiliössä olevan veden.

Käytä vahvempaa kahvijauhetta.

Lisää kahvin vahvuutta lisäämällä kahvijauheen määrää tai vähentämällä veden määrää.

Kahvi valuu suodattimesta yli, kun kannu poistetaan kahvinkeitimestä suodatuksen aikana.

Jos nostat kannun keittimestä yli 20 sekunniksi suodatuksen aikana, tippalukko aiheuttaa sen, että suodatinkori täyttyy ja valuu yli. Huomioi myös, että kahvin täyteläinen maku muodostuu vasta suodatuksen loppuvaiheessa. Siksi kannua ei kannata poistaa ja kahvia kaataa kuppiin, ennen kuin suodatus on valmis.

Kahvinkeitimestä tippuu kahvia pitkään suodatuksen jälkeen.

Tippuminen johtuu höyryn tiivistymisestä. On normaalia, että kahvipisarointi tippuu jonkin aikaa.

En voi odottaa viimeisiä pisaroita.	Käännä nuppi kuppitilasta kannutilaan, jotta tippalukko estää tippumisen suodatinkorista.
	Jos tippuminen jatkuu, tippalukko voi olla tukossa. Puhdista tippalukko avaamalla suodatinkorin teline ja irrottamalla suodatinkori. Huuhtelee suodatinkori ja tippalukko juoksevilla vedellä.
Kahvi ei ole tarpeeksi kuumaa.	Kahvi jäähtyy kannussa nopeammin, jos valmistat vain muutaman kupillisen kahvia. Kahvi säilyy kuumana pidempään, jos keität 10 kupillista eli täyden kannun kahvia.
	Poista kahvinkeitimestä kalkki.
Kahvipavut näyttävät kuluvan nopeasti.	Jotta saat täydellisen kupin kahvia, kahvinkeitimessä on oltava tietty määrä kahvijauhetta. Kahvinkeitin käyttää normaalin määrän kahvipapuja, jotta se saa tarpeeksi jauhettua kahvia kupillista kohti.
Ajastin ei toimi.	Varmista, että kahvipavuista tai kahvijauheesta valmistettavan kahvin kaikki esivalmisteluvaiheet on tehty, ennen kuin asetat ajastimen.

Virhekoodi

Virhekoodi	Kuvaus	Ratkaisu	Huomautus
E1	Liian vähän vettä	Aseta laite valmiustilaan painamalla mitä tahansa painiketta. Täytä vesisäiliö ja käynnistä laite uudelleen.	Jos ongelma ei poistu, toimi seuraavasti: Pidä puhdistus- ja käynnistyspainikkeita painettuina samanaikaisesti kolmen sekunnin ajan, kunnes laite alkaa automaattisesti pumpata vettä minuutin ajan. Toista toimenpide kolme kertaa. Jos ongelma ei edelleenkaan poistu, ota yhteyttä asiakaspalveluun.
E2	Papusäiliö ei ole käytettävissä	Aseta laite valmiustilaan painamalla mitä tahansa painiketta. Kiinnitä papusäiliö kunnolla ja käynnistä laite uudelleen.	Jos ongelma ei poistu, ota yhteyttä asiakaspalveluun.
E3	Lämmitysputkessa on toimintahäiriö	Irrota pistoke pistorasiasta. Kytke laitteen pistoke pistorasiaan ja käynnistä laite uudelleen, kun se on jäähtynyt kokonaan.	Jos ongelma ei poistu, ota yhteyttä asiakaspalveluun.
E4	Jauhatuspyörän tukos	Irrota pistoke pistorasiasta. Kytke laitteen pistoke pistorasiaan ja käynnistä laite uudelleen. Puhdista jauhatuspyörä ja kahvijauhuesuppilon kuilu noudattamalla Myllyn suppilon puhdistaminen -kohdan vaiheita.	Jos ongelma ei poistu, ota yhteyttä asiakaspalveluun.

E5	Kahvijauhesuppilon kuilun tukos	<p>Irrota pistoke pistorasiasta.</p> <p>Kytke laitteen pistoke pistorasiaan ja käynnistä laite uudelleen.</p> <p>Puhdista kahvijauhesuppilon kuilu noudattamalla Myllyn suppilon puhdistaminen -kohdan vaiheita.</p>	Jos ongelma ei poistu, ota yhteyttä asiakaspalveluun.
E6/E7/E8	Ohjelmavirhe	<p>Irrota pistoke pistorasiasta.</p> <p>Kytke laitteen pistoke pistorasiaan ja käynnistä laite uudelleen.</p>	Jos ongelma ei poistu, ota yhteyttä asiakaspalveluun.

Introduktion

Vi gratulerar till ditt köp och hälsar dig välkommen till Philips!

Genom att registrera din produkt på www.philips.com/welcome kan du dra nytta av Philips support.

Allmän beskrivning

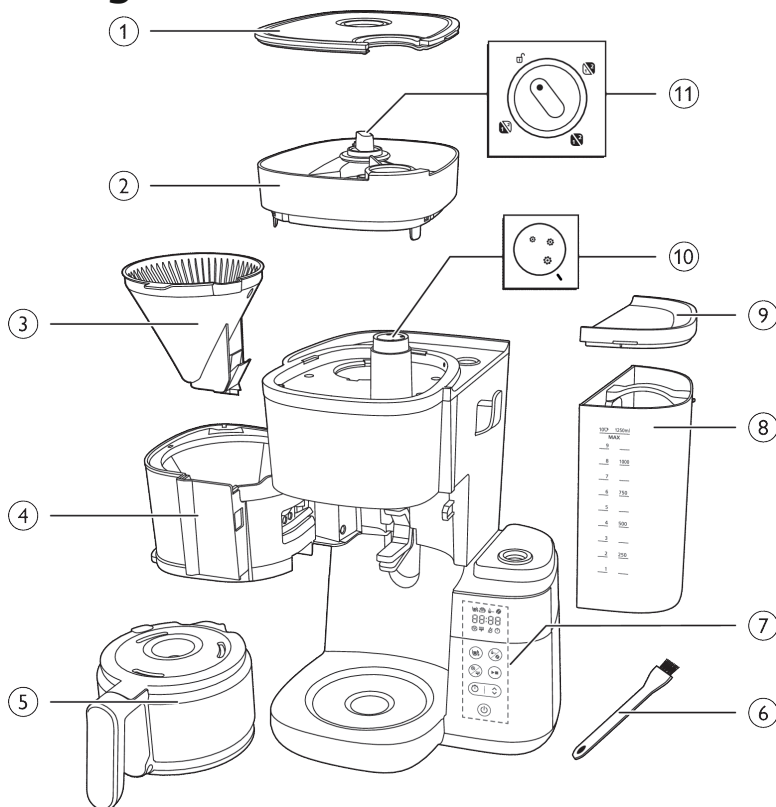

- 1 Lock till behållare för kaffeböner
- 2 Behållare för kaffeböner
- 3 Filterkorg
- 4 Filterkorghållare
- 5 Glaskanna
- 6 Rengöringsborste för rännan till kaffeböner
- 7 Kontrollpanel med display
- 8 Vattenbehållare
- 9 Lock till vattenbehållare
- 10 Grovhetsvred
- 11 Vred för behållarväljare

Kontrollpanel



Strömknapp

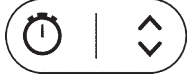

Timerknapp och pilknapp för tidsjustering



Start/paus-knapp



Rengöringsknapp



Knapp för förmalet kaffe och kaffestyrka



Knapp för koppval

Displayikon



Antal koppar



Varmhållningsläge



Förmalet kaffe



Kaffestyrka



Avkalkning



Avisering för manuell rengöring



Låg vattennivå



Timer



Tidsvisning

De två första siffrorna anger timmar och de två sista siffrorna anger minuter.



Vrid vredet till upplåsningsläget och därefter kan du ta ut behållaren för kaffebönor ur apparaten.



Det här vredet väljer hur grovmalet kaffet är, där den större storleken innebär grövre malning.



Kannläge

Droppstoppfunktionen finns i kannläget.

Obs! Bryggningsprocessen stoppar inte när du tar bort kannan. Om du inte trycker tillbaka kannan i apparaten inom 20 sekunder svämmas filterkorgen över.



Koppläge

Vrid vredet manuellt från kopp- till kannläget för att öppna droppstoppfunktionen för att förhindra dropp när bryggningen är klar

Obs! En kall keramikmugg stjälv värme från kaffet när den värmer upp sig själv, så förvärm koppen med varmt vatten.

Viktigt

Varning

- Kontrollera att den spänning som anges på apparaten överensstämmer med den lokala nätspänningen innan du ansluter apparaten.
- Anslut apparaten till ett jordat vägguttag.
- Använd inte apparaten om stickkontakten, nätsladden eller själva apparaten är skadad.
- Om nätsladden är skadad måste den alltid bytas ut av Philips, ett av Philips auktoriserade serviceombud eller liknande behöriga personer för att undvika olyckor.
- Den här produkten kan användas av barn från 8 års ålder, personer med olika funktionshinder samt av personer som inte har kunskap om produkten såvida det sker under tillsyn eller om de har informerats om hur produkten används på ett säkert sätt och de eventuella medförda riskerna. Rengöring och underhåll bör inte göras av barn under 8 år om de inte är under tillsyn av vuxen. Se till att apparaten och dess sladd är utom räckhåll för barn under 8 år.
- Barn ska inte leka med produkten.
- Se till att sladden inte hänger över kanten på bordet eller arbetsbänken där apparaten står.
- Använd endast den här apparaten i dess avsedda syfte för att undvika möjliga faror eller personskador.

Varning

- Skölj alltid apparaten med färskt vatten före första användningen.
- Placera inte apparaten på en varm yta och låt inte nätsladden komma i kontakt med varma ytor.
- Placera inte apparaten i ett skåp när den används.
- Koppla ur apparaten innan du rengör den och om problem uppstår under bryggningen.
- Rengör alltid apparaten när den har svalnat.
- Under bryggning och varmhållning är vattenbehållaren, filterhållaren, värmeplattan, apparatens nedre del och kannan fylld med kaffe varma även en stund efter användning.
- Ställ inte kannan på en spis eller i en mikrovågsugn för att värma upp kaffe.
- Den här apparaten är avsedd att användas i hushåll och liknande miljöer, till exempel bondgårdar, bed and breakfast-miljöer, personalkök i affärer, på kontor och i andra arbetsmiljöer, av gäster på hotell, motell och andra typer av boendemiljöer.
- Lämna alltid in produkten till ett serviceombud auktoriserat av Philips för undersökning och reparation. Öppna inte apparaten och försök inte att reparera den själv.
- Värmeelementets yta, filterhållaren, apparatens nedre del, värmeplattan och kannan fylld med kaffe kan vara varma en stund efter användning.
- Såvida inget annat anges är allt förpackningsmaterial i förpackningen tillverkat av återvunnet papper. Se PAP-märkningen på förpackningen.

Avkalkning

- Avkalka kaffemaskinen när avkalkningsmeddelandet visas på displayen. Använd endast ättika vid avkalkning eftersom andra produkter kan skada apparaten.

Elektromagnetiska fält (EMF)

Den här apparaten från Philips uppfyller standarderna för elektromagnetiska fält (EMF).

Återvinning



Den här symbolen betyder att produkten inte ska slängas bland hushållssoporna (2012/19/EU).

Följ de regler som gäller i ditt land för återvinning av elektriska och elektroniska produkter. Genom att kassera gamla produkter på rätt sätt kan du bidra till att förhindra negativ påverkan på miljö och hälsa.

Såvida inget annat anges är allt förpackningsmaterial i förpackningen tillverkat av återvunnet papper. Se PAP-märkningen på förpackningen.

Garanti och support

Versuni erbjuder två års garanti efter köp av den här produkten. Den här garantin gäller inte om en defekt beror på felaktig användning eller dåligt underhåll. Vår garanti påverkar inte dina lagstadgade rättigheter som

konsument. Besök vår webbplats www.philips.com/support för mer information eller för att återopa garantin.

Före första användningen

Rengör filterhållaren och det permanenta filtret efter varje användning.

Torka filterhållaren noga med en torr trasa efter varje användning. Se till att ta bort eventuell kondens.

Ställa in klockan

- 1 Anslut apparaten.
 - Då börjar timvisaren att blinka.

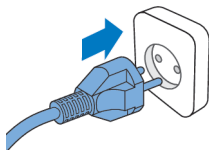

08:00



08:



08:06



- 2 Använd pilknappen för att ändra timinställning.

- 3 När rätt timme har ställts in trycker du på timerknappen för att bekräfta.

- 4 Då börjar minutindikeringen att blinka. Använd pilknappen för att ändra minutinställning.

08:06



08:06

5 Tryck på timerknappen för att bekräfta.

- Aktuell tid är nu inställd och sparad.
- 6 Du kan justera timern i standbyläge på två sätt:
 - Koppla ur apparaten och anslut den igen.
 - Håll timerknappen intryckt tills timsiffrorna börjar blinka.

Obs!

Apparaten sparar alltid den senaste inställningen.

Varmhållningstid

Du kan välja hur länge du vill att kaffet ska hållas varmt efter brygning genom att ändra tiden när apparaten stängs av automatiskt. Standardtiden för automatisk avstängning är 30 minuter. Den maximala tiden för automatisk avstängning är 300 minuter.

Följ stegen nedan för att justera den automatiska avstängningstiden:

- 1 Stäng av apparaten och låt den vara ansluten.
- 2 Håll rengöringsknappen intryckt tills varmhållningsikonen visas och timvisningen börjar blinka.
- 3 Följ steget i Ställa in klockan för att slutföra inställningen.

Skölja apparaten

Skölj alltid kaffebyggaren en gång före första användningen genom att följa stegen nedan.

Varning! Häll aldrig vatten i behållaren för kaffeböner då det skadar kaffebyggaren.

- 1 Öppna vattenbehållarens lock.

Var försiktig! Lägg inte i kaffeböner eller förmalet kaffe i vattenbehållaren

- 2 Du kan fylla på vattenbehållaren med vatten på något av nedanstående sätt:

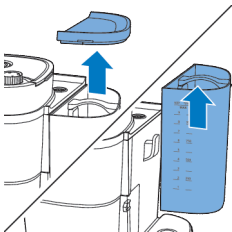



- Lyft ut behållaren ur apparaten och placera den under kranen och fyll på med vatten.

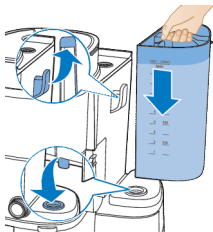

- Se till att kroken sitter fast ordentligt när du sätter tillbaka behållaren.
- Ta tag i lockfliken för att dra upp kannans lock. Placera kaffekannen under kranen och fyll på med vatten. Fyll vattenbehållaren med kaffekannen.
- Se till att vattennivån är nedanför maxnivån.

3 Stäng vattenbehållarens lock.

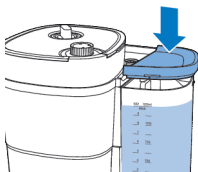

4 Sätt tillbaka kaffekannen i apparaten.

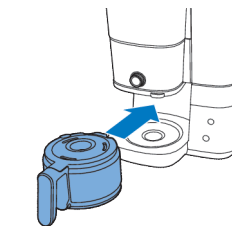

5 Vrid mittenvredet till kanninställningen.

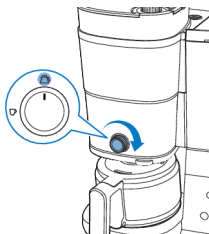

10 3



- 6** Tryck på på/av-knappen.
- Apparaten slås på.



- 7** Tryck på knappen för kaffestyrka och välj föroålet kaffe.

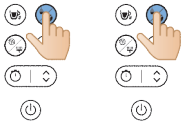

- 8** Tryck på koppknappen och välj 10 koppar.

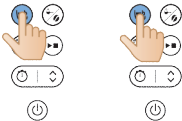

- 9** Tryck på startknappen.



- 10** Apparaten startar sköljprocessen.
11 Kör apparaten tills spolningsprocessen är klar.

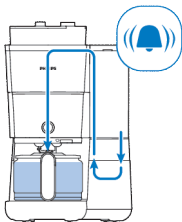



12 Töm glaskannan.

Använda apparaten

Använda kaffeböror

Obs! Kaffebryggaren använder den mängd vatten som behövs baserat på antalet kaffekoppar som ska bryggas

Följ stegen nedan för användning:

1 Öppna vattenbehållarens lock och lyft ut behållaren ur apparaten.

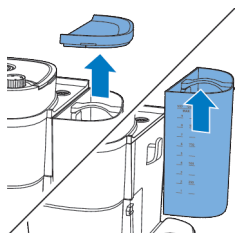

2 Fyll behållaren med vatten från kranen.
- Se till att vattennivån är under maxnivån.

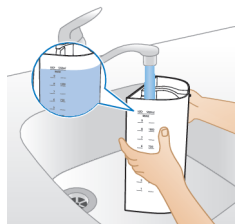

3 Sätt tillbaka behållaren i apparaten.
- Se till att kroken är ordentligt fastsatt.

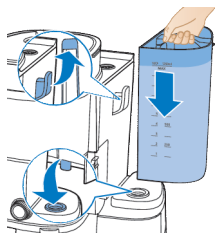

- 4 Stäng locket till vattenbehållaren.

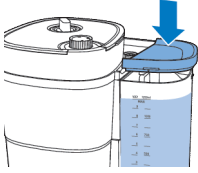

- 5 Lyft upp locket till behållaren för kaffeböner.

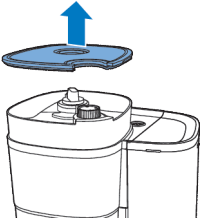

- 6 Tillsätt önskade kaffeböner i behållaren.

Obs! Se alltid till att den dubbla behållaren för färska kaffeböner är minst halvfull.

Varning! För att förhindra att kvarnen blockeras bör du inte använda orostade eller karamelliserade bönor. Använd kaffeböner i stället för espressoböner eftersom espressoböner kan skada kvarnen.

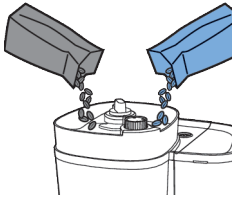

- 7 Stäng locket till behållaren för kaffeböner.

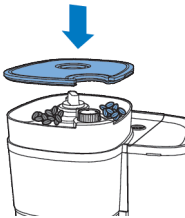

- 8 Vrid behållarens väljare för att välja önskade bönor från de två behållarna.
- Du kan även blanda två olika sorters bönor för en unik blandning.

Obs! När du växlar mellan behållare för kaffeböner eller kaffeböner kommer det alltid att finns spår av kaffe från den typ av kaffeböner som malts tidigare. Rengör malningstratten när du byter till en ny typ av kaffeböna för att förhindra detta.

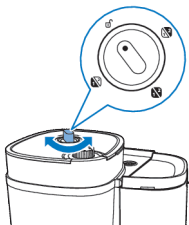

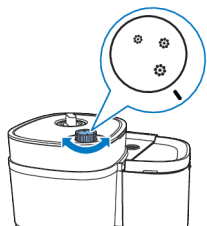

9 Välj önskad grovhet med vredet.

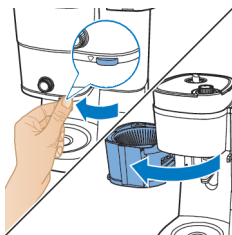

10 Ta tag i fliken för att öppna filterhållaren.

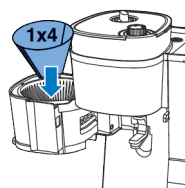

11 Lägg i ett pappersfilter (typ 1x4 eller nummer 4) i filterkorgen.

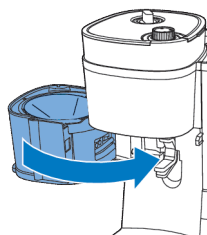

12 Stäng filterhållaren.

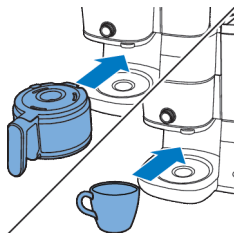

13 Sätt kaffekannan eller kaffekoppen under doseraren.

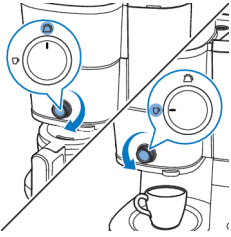

14 Använd vredet för att välja den mängd kaffe du vill brygga.

När du använder koppfunktionen kan du använda en glas- eller keramik kopp eller ett glas. Se till att du använder koppar som är lägre än tio centimeter.

☕ 3
10 3

15 Slå på apparaten.



16 Välj hur många koppar du vill brygga genom att trycka på koppknappen.



17 Tryck på styrkeknappen för att välja önskad kaffestyrka.

- 1: Bönor för svagt kaffe
- 2: Bönor för medelstarkt kaffe
- 3: Bönor för starkt kaffe



18 Tryck på start/paus-knappen för att påbörja processen.



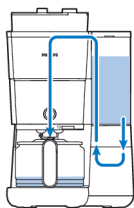

19 Apparaten börjar då brygga kaffet.

- Apparaten piper när kaffet är klart.

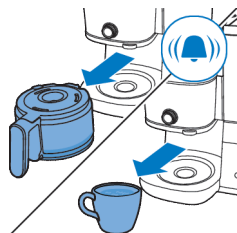

20 Ta bort koppen eller kaffekannan från apparaten.

Droppstoppfunktionen gör att du kan ta bort kannan från kaffebyggaren innan bryggningsprocessen är klar. När du tar bort kannan förhindrar dropstoppet att kaffet rinner ned i kannan.

Bryggningsprocessen stoppar inte när du tar bort kannan. Om du inte trycker tillbaka kannan i apparaten inom 20 sekunder svämmar filterkorgen över.



21 Njut av ditt nybryggda kaffe.

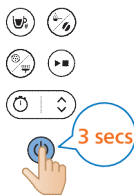

22 Håll start/paus-knappen intryckt i tre sekunder för att stänga av apparaten.

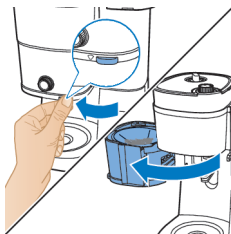

23 Öppna filterhållaren.

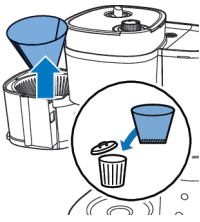

24 Ta bort det använda pappersfiltret.

Varmhållningsfunktionen aktiveras inte när du brygger en eller två koppar.

Apparaten håller drycken varm tills den stängs av automatiskt. Om du inte vill att drycken ska hållas varm längre trycker du på på/av-knappen för att stänga av apparaten.

Använda förmalet kaffe

Följ stegen nedan för användning:

1 Kontrollera att apparaten har tillräckligt med vatten för att brygga önskad mängd kaffe.

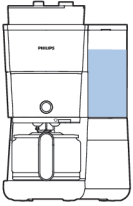

2 Ta tag i fliken för att öppna filterhållaren.

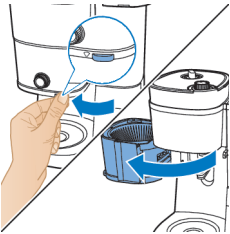

3 Lägg i ett pappersfilter (typ 1x4 eller nummer 4) i filterkorgen.

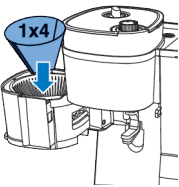

4 Tillsätt den mängd förmalet kaffe i pappersfiltret som du brukar använda.
- Använd sex gram malet kaffe eller en matsked för en vanlig kopp kaffe.

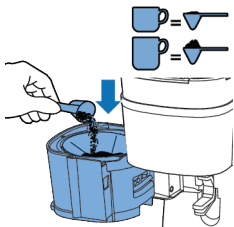

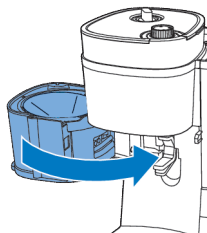

5 Stäng filterhållaren.

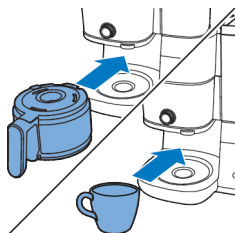

6 Sätt kaffekannan eller kaffekoppen under doseraren.

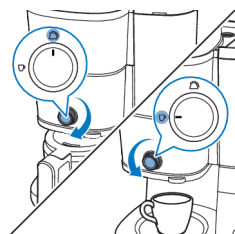

7 Använd vredet för att välja den mängd kaffe du vill brygga.

10 3

8 Slå på apparaten.



10 3 → 10 1

9 Välj att använda förmalet kaffe genom att trycka på knappen för lägesval.



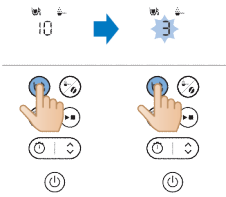

10 Välj hur många koppar du vill brygga genom att trycka på koppknappen.



11 Tryck på start/paus-knappen för att påbörja processen.



12 Apparaten börjar då brygga kaffet.

- Apparaten piper när kaffet är klart.

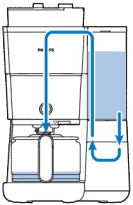

13 Ta bort koppen eller kaffekannan från apparaten.

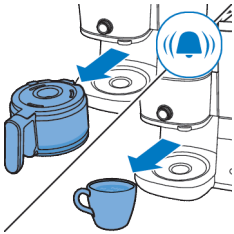

14 Njut av ditt nybryggda kaffe.



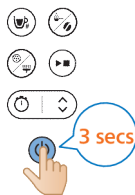

15 Håll start/paus-knappen intryckt i tre sekunder för att stänga av apparaten.

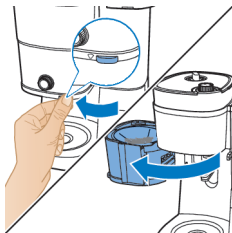

16 Öppna filterhållaren.

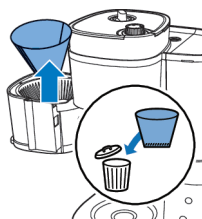

17 Ta bort det använda pappersfiltret.

Ställa in timern

Följ de här stegen för att ställa in apparatens timer:

- 1 Slå på kaffebyggaren.
- 2 Tryck på timerknappen så visas timerikonen på displayen. Timsiffrorna blinkar vilket anger att du kan ställa in timmarna.

08:06



08:00



- 3 Använd pilknappen för att ställa in timmarna. Om du behöver ändra snabbt trycker du länge på pilknappen.

08:



- 4 Tryck på timerknappen för att bekräfta timinställningen. Minutsiffrorna anger att du kan ställa in minuterna.



08:05



- 5 Använd pilknappen igen för att ändra minuterna. Om du behöver ändra snabbt trycker du länge på pilknappen.

08:05



- 6 Tryck på timerknappen för att bekräfta minutinställningen.
Avbryt timern genom att trycka på timerknappen så försvinner timerikonen från displayen.

Droppstoppfunktionen gör att du kan ta bort kannan från kaffebyggaren innan brygningsprocessen är klar. När du tar bort kannan förhindrar droppstoppet att kaffet rinner ned i kannan.

Obs! Brygningsprocessen stoppar inte när du tar bort kannan. Om du inte trycker tillbaka kannan i apparaten inom 20 sekunder svämmar filterkorgen över.

Rengöring och underhåll

Rengöring efter varje användning

Sänk aldrig ned kaffebyggaren i vatten eller någon annan vätska och skölj den inte under kranen.

1 Ta ut kontakten ur vägguttaget.

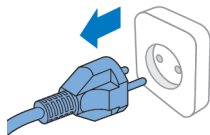







2 Torka kaffebryggarens utsida med en fuktig trasa.

3 Rengör filterkorgen med hett vatten och lite diskmedel, eller diska dem i diskmaskinen.



4 Rengör kaffekannan och locket under kranen. Eller diska dem i diskmaskinen.

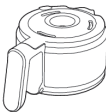
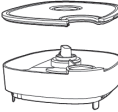

			
	✓	✓	✓
	✓	✓	✓
	✓	✓	✓
	✓	✗	✓
	✓	✗	✓

Rengöra kvarntratten

Viktigt:

Rengör kvarnratten varje eller varannan vecka för att förhindra att den täpps igen med malet kaffe. Det gör du snabbt och enkelt genom att följa stegen nedan.

Rengör kvarnratten om du ser en borstvarning på displayen.

Obs! Se till att behållaren för kaffebönor är tom innan du startar rengöringsproceduren.

1 Anslut apparaten.

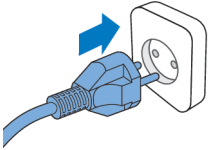

2 Öppna filterhållaren för att få åtkomst till trattrännan.

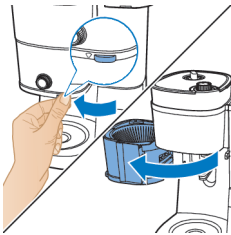

3 Slå på kaffebyggaren.

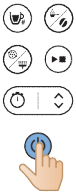

4 Tryck på rengöringsknappen på kaffebyggarens kontrollpanel.

5 Välj borstinställningen på displayen.





- 6 Tryck på startknappen. Då öppnas trattrännans lucka så att du kan rengöra rännan med en borste.

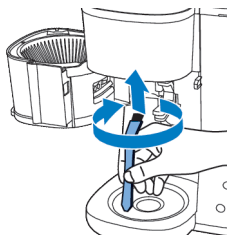

- 7 Använd en borste för att ta bort malet kaffe eller rester som kan ha samlats i rännan.



- 8 När du har rengjort rännan trycker du på startknappen igen för att stänga luckan.

Avkalka kaffebryggaren

Avkalka kaffemaskinen när avkalkningsmeddelandet visas på displayen. Använd endast ättika vid avkalkning eftersom andra produkter kan skada kaffebryggaren.

Varning! Använd aldrig ättika med en ättiksyra på 8 % eller mer, naturlig ättika eller avkalkningsmedel i pulver- eller tablettform för att avkalka kaffebryggaren då det kan leda till skador.

- 1 Öppna vattenbehållarens lock.

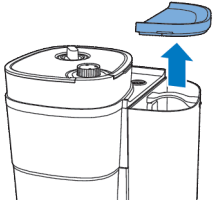

- 2 Fyll vattentanken med ättika (4 % ättiksyras) upp till indikeringen för 10 koppar.

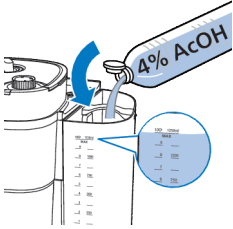

- 3 Stäng locket till vattenbehållaren.

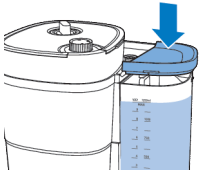

- 4 Ta tag i fliken för att öppna filterhållaren.

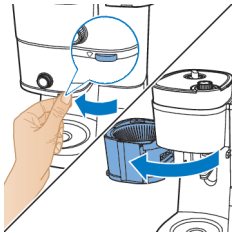

- 5 Lägg ett pappersfilter (typ 1x4 eller nummer 4) i filterkorgen och stäng filterkorghållaren.

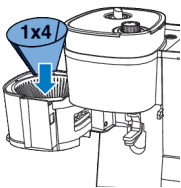

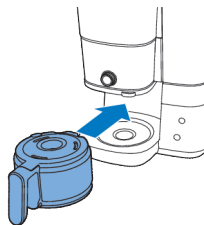

- 6 Ställ den tomma kannan i kaffebyggaren.
- 7 Sätt i kontakten i vägguttaget.

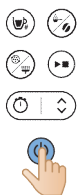

- 8 Slå på kaffebyggaren genom att trycka på strömknappen. Då tänds displayen.

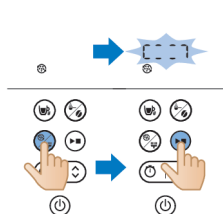

- 9 Tryck på rengöringsknappen på kaffebyggaren.
 - 10 Välj avkalkningsinställningen.
 - 11 Bekräfta valet genom att trycka på startknappen.
- Kaffebyggaren påbörjar automatiskt avkalkningsprocessen.

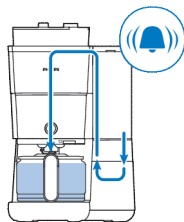

- 12 Vänta tills kaffebyggaren har bryggt klart avkalkningslösningen.
- 13 När avkalkningsprocessen är klar sköljer du kaffebyggaren två gånger med maximal mängd vatten för att ta bort eventuella rester helt.

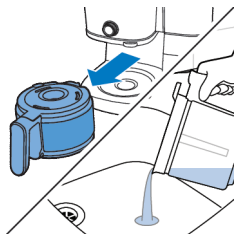

- 14 Töm kannan och ta bort pappersfiltret med kalkresterna.
 - 15 Fyll vattenbehållaren med rent kallt vatten och tryck på startknappen för att starta en ny brygningsprocess.
- Vänta tills kaffebyggaren har slutfört hela brygningsprocessen och töm sedan kannan.

Obs! Du måste upprepa steg 14 tills vattnet som kommer ut ur kaffebyggaren inte längre smakar eller luktar ättika.

- 16 Rengör filterkorgen och kannan med varmt vatten och lite diskmedel.
- 17 Stäng av apparaten genom att trycka på strömknappen.

Felsökning

I det här kapitlet sammanfattas de vanligaste problemen som du kan råka ut för med maskinen. Om du inte kan lösa problemet med hjälp av informationen nedan kan du gå till www.philips.com/support där det finns en lista med vanliga frågor. Du kan även kontakta kundtjänst i ditt land.

Du kan även skanna den här QR-koden för mer onlinesupport.



Problem	Lösning
Kaffebryggaren fungerar inte.	Sätt i kontakten i vägguttaget och tryck på på/av-knappen för att slå på kaffebryggaren.
	Kontrollera att den spänning som anges på kaffebryggaren överensstämmer med den lokala nätspänningen.
	Fyll vattenbehållaren med vatten.
	Stäng locket till kvarntratten.
Kvarnen fungerar inte eller fungerar inte som den ska.	Kontrollera att du inte har valt förmalet kaffe. Du har valt förmalet kaffe om symbolen för förmalet kaffe visas på displayen.
	Rengör kvarntratten genom att följa instruktionerna.
Kaffet blir för svagt när jag använder kvarnen.	Vrid på grovleksvredet för att välja önskad malningstyp från fin till grov.
	Använd knappen för kaffestyrka för att ställa in kaffestyrkan från 1 till 3 där den högre siffran innebär starkare kaffe.
	Använd kaffeböner med en starkare blandning eller smak.
Kaffet blir för svagt när jag använder förmalet kaffe.	Se till att mängden förmalet kaffe i filtret stämmer överens med mängden vatten i vattenbehållaren. Tänk på att kaffebryggaren använder allt vatten i vattenbehållaren.
	Använd malet kaffe med en starkare blandning eller smak.
	Öka kaffestyrkan genom att öka mängden förmalet kaffe eller minska mängden vatten.
Filtret svämmar över när jag tar bort kannan från kaffebryggaren under pågående bryggningsprocessen.	Om du tar bort kannan i mer än 20 sekunder under bryggningsprocessen leder droppstoppet till att filterkorgen svämmar över. Observera även att kaffet inte når sin fulla smak förrän i slutet av bryggningsprocessen. Därför rekommenderar vi att du inte tar bort kannan och håller upp kaffet innan bryggningsprocessen är klar.
Kaffebryggaren fortsätter droppa långt efter att bryggningsprocessen är klar.	Droppandet orsakas av kondenserad ånga. Det är helt normalt att kaffebryggaren droppar en stund.

Kan inte vänta på de sista dropparna.	Vrid vredet från kopp- till kannläge för att öppna droppstoppfunktionen. Droppstoppfunktionen stoppar droppandet från filterkorgen.
	Om droppandet inte stoppar kan det hända att droppstoppet är igensatt. Rengör droppstoppet genom att öppna filterkorghållaren och ta ut filterkorgen. Skölj filterkorgen och droppstoppet under kranen.
Kaffet är inte tillräckligt varmt.	Kaffet i kannan svalnar fortare om du bara brygger några koppar. Kaffet håller sig varmt längre om du brygger tio koppar, det vill säga en full kanna.
	Avkalka kaffebyggaren.
Det verkar som om kaffebönorna går åt snabbt.	Kaffebyggaren behöver en viss mängd malet kaffe för att brygga en perfekt kopp kaffe. Mängden kaffebönor som kaffebyggaren använder för att få optimal mängd malet kaffe per kopp är normal.
Timern fungerar inte.	Se till att du slutför alla steg för att brygga kaffe med kaffebönor eller förmalet kaffe innan du ställer in timern.

Felkod

Felkod	Beskrivning	Lösning	Kommentar
E1	För lite vatten	Tryck på valfri knapp för att aktivera apparatens standbyläge. Fyll på vattenbehållaren och starta om apparaten.	Följ de här stegen om problemet kvarstår: Håll rengörings- och startknappen intryckta samtidigt i tre sekunder tills apparaten automatiskt börjar pumpa vatten i en minut. Upprepa den här processen tre gånger. Kontakta kundtjänst om problemet kvarstår.
E2	Behållaren för kaffebönor är inte tillgänglig	Tryck på valfri knapp för att aktivera apparatens standbyläge. Sätt fast behållaren för kaffebönor och starta om apparaten	Kontakta kundtjänst om problemet kvarstår.
E3	Värmeröret fungerar inte	Dra ur nätsladden. Anslut nätsladden och slå på apparaten igen när den har svalnat helt.	Kontakta kundtjänst om problemet kvarstår.
E4	Blockering av kvarnhjulet	Dra ur nätsladden. Anslut nätsladden och slå på apparaten igen. Följ stegen i Rengöra kvarntratten för att rengöra kvarnhjulet och trattrännan.	Kontakta kundtjänst om problemet kvarstår.

E5	Blockering av trattrännan	Dra ur nätsladden. Anslut nätsladden och slå på apparaten igen. Följ stegen i Rengöra kvartratten för att rengöra trattrännan.	Kontakta kundtjänst om problemet kvarstår.
E6/E7/E8	Programfel	Dra ur nätsladden. Anslut nätsladden och slå på apparaten igen.	Kontakta kundtjänst om problemet kvarstår.

Giriş

Satın alma tercihiniz için teşekkür ederiz, Philips'e hoş geldiniz!
Philips'in sunduğu destekten tam olarak yararlanmak için ürününüzü www.philips.com/welcome adresinde kaydettirin.

Genel açıklama

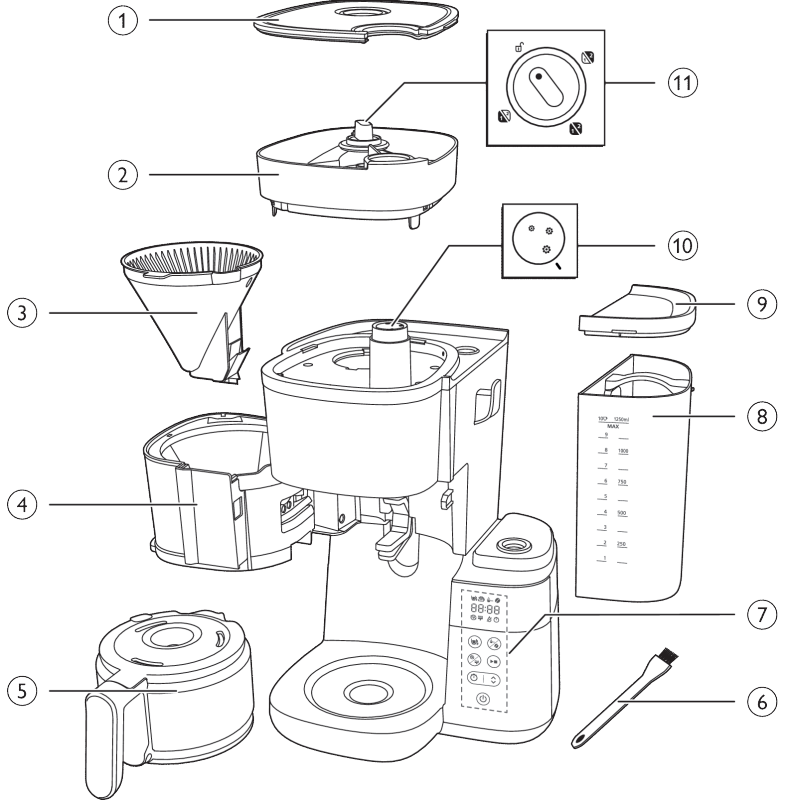

- 1 Kahve çekirdeği haznesinin kapağı
- 2 Kahve çekirdeği haznesi
- 3 Filtre sepeti
- 4 Filtre sepeti tutucusu
- 5 Cam sürahi
- 6 Kahve çekirdeği kanalı temizleme fırçası
- 7 Ekranlı kontrol paneli
- 8 Su haznesi
- 9 Su haznesi kapağı
- 10 Öğütme kalınlığı düğmesi
- 11 Hazne seçici düğmesi

Kontrol paneli



Güç düğmesi



Zaman ayarı için zamanlayıcı düğmesi ve ok düğmesi



Başlat/duraklat düğmesi



Temizleme düğmesi



Ön öğütme ve kahve sertliği düğmesi



Fincan seçim düğmesi

Ekran simgesi



Fincan sayısı



Sıcak tutma modu



Önceden öğütülmüş kahve



Kahve sertliği



Kirecin temizlenmesi



Manuel temizleme uyarısı



Düşük su miktarı



Zamanlayıcı



Zaman göstergesi

İlk iki hane saati, son iki hane ise dakikayı temsil eder.



Düğmeyi kilit açma konumuna çevirin, ardından kahve çekirdeği haznesini cihazdan çıkarabilirsiniz.



Bu düğme kahvenin öğütülme kalınlığını seçer. Daha büyük boyut, daha kalın öğütme işlemini belirtir.



Sürahi modu

Damlama önleme işlevi, sürahi modunda mevcuttur.

Not: Sürahiye çıkardığınızda kahve demleme işlemi durmaz. Sürahiye 20 saniye içinde cihaza geri koymazsanız filtre sepeti taşar.



Fincan modu

Kahve demleme işlemi bittikten sonra damlamayı önlemek için düğmeyi fincan modundan sürahi moduna manuel olarak geçirerek damlama önleyiciyi açın

Not: Soğuk seramik kupa, kendisini ısıtırken kahvenin ısısını çalar. Lütfen fincanı sıcak suyla önceden ısıtın.

Önemli

Uyarı

- Cihazı prize takmadan önce cihazın üstünde yazılı olan gerilimin evinizdeki şebeke gerilimiyle aynı olup olmadığını kontrol edin.
- Cihazı topraklı prize takın.
- Cihazın fişi, elektrik kablosu veya kendisi hasarlıysa kesinlikle kullanmayın.
- Cihazın elektrik kablosu hasarlıysa bir tehlike oluşturmasını önlemek için mutlaka Philips'in yetki verdiği bir servis merkezi veya benzer şekilde yetkilendirilmiş kişiler tarafından değiştirilmesini sağlayın.
- Bu cihazın 8 yaşın üzerindeki çocuklar ve fiziksel, duyuşsal ya da zihinsel becerileri gelişmemiş veya bilgi ve tecrübe açısından eksik kişiler tarafından kullanımı, sadece bu kişilerin gözetim altında olmaları veya cihazı güvenli kullanmaya yönelik talimatların bu kişilere sağlanması ve dahil olan tehlikeleri anlamaları durumunda mümkündür. Temizlik ve kullanıcı bakımı, 8 yaşından büyük ve gözetim altında olmadıkları sürece, çocuklar tarafından yapılmamalıdır. Cihazı ve kablosunu 8 yaşından küçük çocukların erişemeyecekleri yerlerde muhafaza edin.
- Çocuklar cihazla oynamamalıdır.
- Güç kablosunun, cihazın yerleştirildiği masa ya da tezgahın sarkmamasına dikkat edin.
- Bu cihazı, olası tehlike veya yaralanmaları önlemek için yalnızca kullanım amacı doğrultusunda kullanın.

Dikkat

- İlk kullanımdan önce cihazı mutlaka temiz suyla yıkayın.
- Cihazı sıcak bir yüzeye koymayın ve elektrik kablosunun sıcak yüzeylerle temas etmesine izin vermeyin.
- Cihazı kullanım sırasında dolaba koymayın.
- Cihazı temizlemeden önce ve kahve demlerken sorun çıkarsa fişini prizden çekin.
- Cihazı her zaman soğuduktan sonra temizleyin.
- Kahve demleme ve sıcak tutma sırasında su haznesi, filtre tutucusu, sıcak plaka, cihazın alt kısmı ve kahve dolu sürahi, bir süre geçtikten sonra bile sıcak kalır.
- Kahveyi tekrar ısıtmak için sürahiyi ocağa veya mikrodalga fırına koymayın.
- Bu cihaz; çiftlik evleri, pansiyonlar, mağazalardaki personel mutfağı alanları, ofisler ve diğer çalışma ortamları gibi ve oteller, moteller ve diğer konaklama ortamlarındaki müşteriler tarafından olacak şekilde, ev ve benzeri yerlerde kullanıma uygundur.
- Cihazı kontrol veya onarım için mutlaka yetkili bir Philips servis merkezine gönderin. Cihazı açmayın veya kendiniz onarmaya çalışmayın.
- Isıtma elemanı yüzeyi, filtre tutucusu, cihazın alt kısmı, sıcak plaka ve kahveyle dolu sürahi, kullanımdan sonra bir süre boyunca kalan ısıya maruz kalır.
- Aksi belirtilmedikçe, kutudaki tüm ambalaj malzemeleri geri dönüştürülmüş kağıttan üretilmiştir. Kutudaki PAP işaretine bakın.

Kirecin temizlenmesi

- Ekranda kireç temizleme uyarısı görüntülediğinde kahve makinesinin kirecini temizleyin. Kireci temizlemek için sadece beyaz sirke kullanın, aksi halde diğer ürünler cihaza zarar verebilir.

Elektromanyetik alanlar (EMF)

Bu Philips cihazı elektromanyetik alanlar (EMF) ile ilişkili tüm standartlara uygundur.

Geri dönüşüm



Bu simge, ürünün normal evsel atıklarla birlikte atılmaması gerektiği anlamına gelir (2012/19/AB).

Elektrikli ve elektronik ürünlerin ayrı olarak toplanması ile ilgili ülkenizin kurallarına uyun. Eski ürünlerin doğru şekilde atılması, çevre ve insan sağlığı üzerindeki olumsuz etkileri önlemeye yardımcı olur.

Aksi belirtilmedikçe, kutudaki tüm ambalaj malzemeleri geri dönüştürülmüş kağıttan üretilmiştir. Kutudaki PAP işaretine bakın.

Garanti ve destek

Versuni, bu ürün için satın aldıktan sonra iki yıllık garanti sunar. Bu garanti, arızanın yanlış kullanım veya kötü bakım nedeniyle ortaya çıkması durumunda geçerli değildir. Garantimiz, tüketici olarak kanunen haklarınızı etkilemez. Daha

fazla bilgi almak veya garantiye başvurmak için lütfen www.philips.com/support adresindeki web sitemizi ziyaret edin.

İlk kullanımdan önce

Her kullanımdan sonra filtre tutucusunu ve sabit filtreyi temizlediğinizden emin olun.

Her kullanımdan sonra filtre tutucusunu kuru bir bezle iyice silin. Yoğuşma birikintilerini temizlemeyi unutmayın.

Saati ayarlama

- 1 Cihazı prize takın.
 - Saat göstergesi yanıp sönmeye başlar.

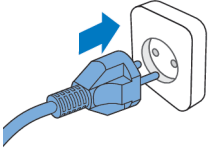

08:00



08:



08:05



- 2 Saati ayarlamak için ok düğmesini kullanın.

- 3 Saat ayarlandıktan sonra saati onaylamak için zamanlayıcı düğmesine basın.

- 4 Dakika göstergesi yanıp sönmeye başlar. Dakikayı ayarlamak için ok düğmesini kullanın.

08:06



08:06

5 Dakikayı onaylamak için zamanlayıcı düğmesine basın.

- Geçerli saat ayarlanır ve kaydedilir.
- 6 Bekleme modunda zamanlayıcıyı ayarlamak için aşağıdaki iki yaklaşım arasından seçim yapabilirsiniz:
 - Cihazın fişini çıkarıp tekrar takın.
 - Saat haneleri yanıp sönmeye başlayana kadar zamanlayıcı düğmesini basılı tutun.

Not

Cihaz her zaman son ayarı kaydeder.

Sıcak tutma süresi

Cihaz otomatik olarak kapandıktan sonra süreyi ayarlayarak kahvenizin demleme işleminin ardından ne kadar süre sıcak kalacağını seçebilirsiniz. Varsayılan otomatik kapanma süresi 30 dakikadır. Maksimum otomatik kapanma süresi 300 dakikadır.

Otomatik kapanma süresini ayarlamak için aşağıdaki adımları izleyin:

- 1 Cihazı kapatın ve prize takılı bırakın.
- 2 Sıcak tutma simgesi görüntülenene ve saat yanıp sönmeye başlayana kadar temizleme düğmesini basılı tutun.
- 3 Ayarı tamamlamak için "Saati ayarlama" bölümündeki adımı izleyin.

Cihazı yıkama

Aşağıdaki adımları uygulayarak ilk kullanımdan önce kahve makinesini mutlaka yıkayın.

Uyarı: Kahve makinesine zarar vereceğinden kahve çekirdeği haznesine kesinlikle su dökmeyin.

- 1 Su haznesinin kapağını açın.

Dikkat: Su haznesine kahve çekirdekleri veya önceden öğütülmüş kahve koymayın

- 2 Aşağıdaki yöntemlerden birini izleyerek su haznesini suyla doldurabilirsiniz:

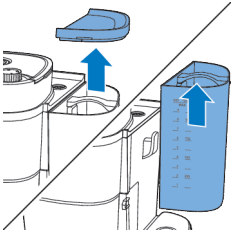

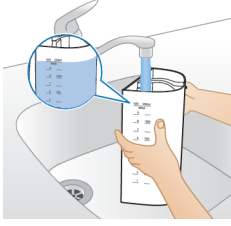

- Hazneyi cihazdan kaldırın ve su doldurmak için musluğun altına yerleştirin.

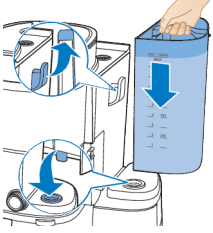

- Geri yerleştirirken çengelin düzgün takıldığından emin olun.
- Sürahi kapağını yukarı çekmek için kapak tırnağını tutun. Su doldurmak için kahve sürahisini musluğun altına yerleştirin. Kahve sürahisiyle su haznesini doldurun.
- Suyun maksimum seviyenin altında olduğundan emin olun.

3 Su haznesinin kapağını kapatın.

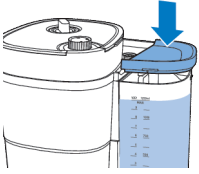

4 Kahve sürahisini cihaza koyun.

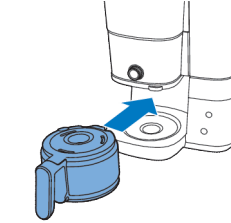

5 Orta düğmeyi sürahi ayarına getirin.

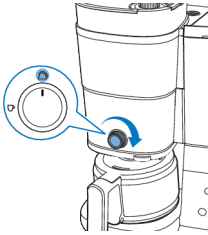

10 3



- 6** Açma/kapatma düğmesine basın.
- Cihaz açılır.

10 10



10 10



- 7** Kahve sertliği düğmesine basın ve önceden öğütülmüş kahveyi seçin.

10 10



10 10



- 8** Fincan düğmesine basın ve 10 bardak seçin.



- 9** Başlat düğmesine basın.

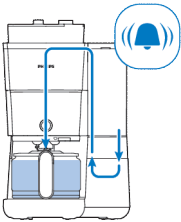

- 10** Cihaz, yıkama işlemini başlatır.

- 11** Yıkama işlemi bitene kadar cihazın çalışmasına izin verin.



12 Cam sürahiyi boşaltın.

Cihazı kullanma

Kahve çekirdeklerini kullanma

Not: Kahve makinesi, hazırlanacak kahve fincanı sayısına göre gereken miktarda su kullanır

Kullanmak için aşağıdaki adımları izleyin:

1 Su haznesinin kapağını açın ve hazneyi cihazdan kaldırın.

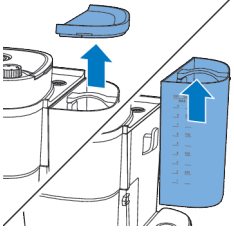

2 Hazneyi suyla doldurun.

- Suyun maksimum seviyenin altında olduğundan emin olun.

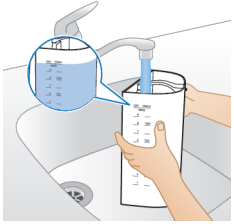

3 Hazneyi cihaza geri takın.

- Çengelin düzgün şekilde takıldığından emin olun.

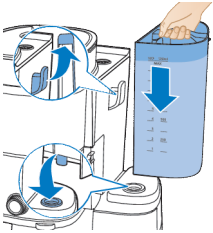

4 Su haznesinin kapağını kapatın.

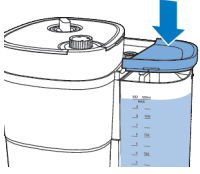

5 Kahve çekirdeği haznesinin kapağını kaldırın.

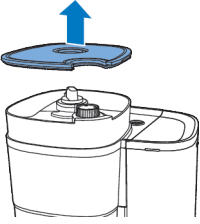

6 İsteddiğiniz kahve çekirdeklerini hazneye ekleyin.

Not: İkili kahve çekirdeği haznesinin taze kahve çekirdeği ile en az yarısının dolu olduğundan her zaman emin olun.

Uyarı: Öğütücünün sıkışmasını önlemek için kavrulmamış veya karamelize kahve çekirdekleri kullanmayın. Espresso çekirdekleri öğütücüye zarar verebileceğinden, espresso çekirdekleri yerine kahve çekirdeği kullanın.

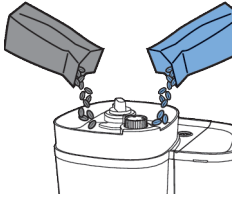

7 Kahve çekirdeği haznesinin kapağını kapatın.

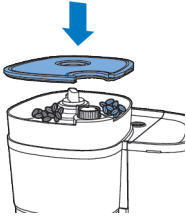

8 İki hazne arasından istenen kahve çekirdeklerini seçmek için hazne seçici düğmesini çevirin.

- Benzersiz bir karışım için iki farklı kahve çekirdeği türünü bile karıştırabilirsiniz.

Not: Kahve çekirdeği hazneleri veya kahve çekirdekleri arasında geçiş yaptığınızda, her zaman daha önceki kahve çekirdeğinin öğütülmüş halinden kalan kahve kalıntıları olur. Bunu önlemek için yeni bir kahve çekirdeği türüne geçtikten sonra öğütücü hunisini temizleyin.

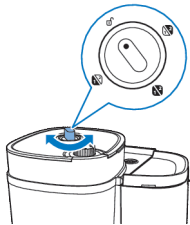

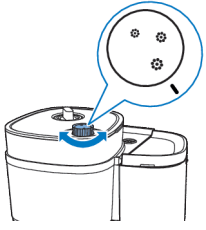

9 Düğmeyi kullanarak istediğiniz öğütme kalınlığı seviyesini seçin.

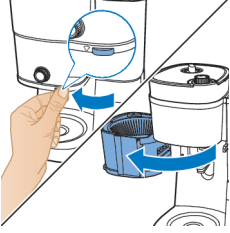

10 Filtre tutucusunu açmak için tırnağı tutun.

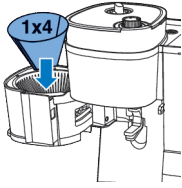

11 Kağıt filtreyi (tip 1x4 veya no. 4) filtre sepetine yerleştirin.

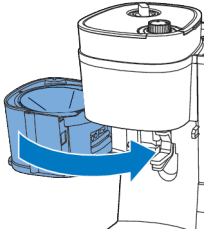

12 Filtre tutucusunu kapatın

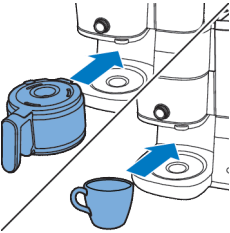

13 Kahve sürahisini veya fincanı dağıtıcının altına yerleştirin.

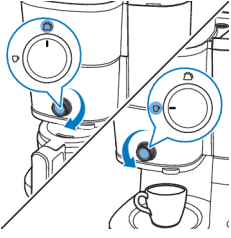

14 Yapmak istediğiniz kahve miktarını seçmek için düğmeyi kullanın.

Fincana demleme işlevini kullanırken, cam ya da seramik kupaların yanı sıra cam bardak da kullanabilirsiniz. Yüksekliği 10 cm'den az olan fincanlar kullandığınızdan emin olun.

10 3

15 Cihazı açın.



16 Fincan düğmesine basarak yapmak istediğiniz fincan sayısını seçin.

1 3



17 Tercih ettiğiniz kahve sertliğini seçmek için sertlik düğmesine basın.

- 1: Hafif kahve için kahve çekirdeği
- 2: orta sertlikte kahve için kahve çekirdekleri
- 3: sert kahve için kahve çekirdekleri

1 2



18 Başlat/duraklat düğmesine basarak işlemi başlatın.

[]



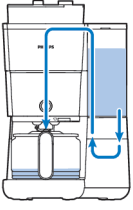

19 Cihaz işleme başlar.

- İşlem tamamlandığında cihaz bip sesi çıkarır.

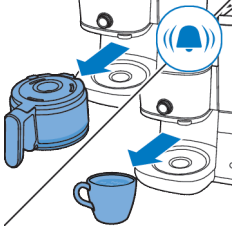

20 Fincanınızı veya kahve sürahisini cihazdan çıkarın.

Damlama önleme işlevi, kahve yapma işlemi tamamlanmadan önce sürahiyi kahve makinesinden çıkarmanıza olanak tanır. Damlama önleyici, sürahiyi çıkardığınızda sürahiye kahve akışını durdurur.

Sürahiyi çıkardığınızda kahve demleme işlemi durmaz. Sürahiyi 20 saniye içinde cihaza geri koymazsanız filtre sepeti taşar.



21 Taze demlenmiş kahvenizin keyfini çıkarın.



22 Cihazı kapatmak için başlat/duraklat düğmesini üç saniye basılı tutun.

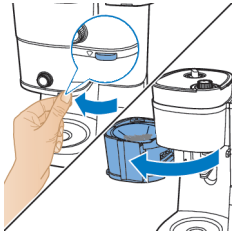

23 Filtre tutucusunu açın.

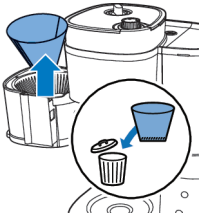

24 Kullanılmış kağıt filtreyi çıkarın.

Sıcak tutma işlevi bir veya iki fincan kahve yapılırken etkinleşmez.

Cihazınız otomatik olarak kapanana kadar içeceğinizi sıcak tutar. İçeceğinizin artık sıcak kalmasını istemiyorsanız açma/kapatma düğmesine basarak cihazı kapatın.

Önceden öğütülmüş kahveyi kullanma

Kullanmak için aşağıdaki adımları izleyin:

- 1 Cihazda istediğiniz miktarda kahve yapmak için yeterli su olup olmadığını kontrol edin.



- 2 Filtre tutucusunu açmak için tırnağı tutun.

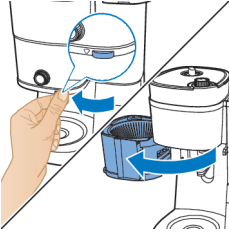

- 3 Kağıt filtreyi (tip 1x4 veya no. 4) filtre sepetine yerleştirin.

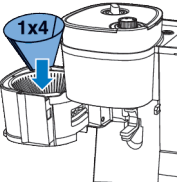

- 4 Kişisel tercihinize göre kullandığınız kağıt filtreye önceden öğütülmüş kahve miktarını ekleyin.
 - Standart bir fincan kahve için 6 gram öğütülmüş kahve veya 1 yemek kaşığı kullanın.

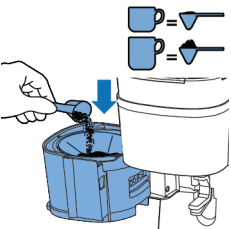

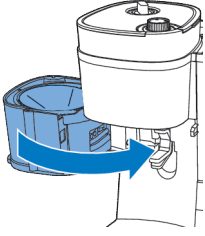

5 Filtre tutucusunu kapatın.

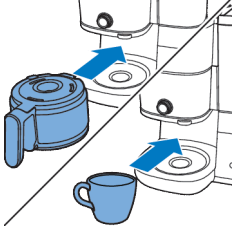

6 Kahve sürahisini veya fincanı dağıtıcının altına yerleştirin.

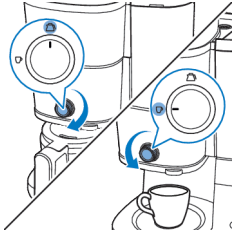

7 Yapmak istediğiniz kahve miktarını seçmek için düğmeyi kullanın.

10 3

8 Cihazı açın.

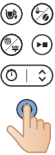

10 3 → 10 1

9 Mod seçim düğmesine basarak önceden öğütülmüş kahveyi kullanmayı seçin.

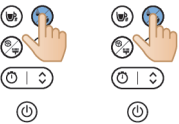



10 Fincan düğmesine basarak yapmak istediğiniz fincan sayısını seçin.

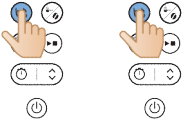

11 Başlat/duraklat düğmesine basarak işlemi başlatın.



12 Cihaz işlemeye başlar.

- İşlem tamamlandığında cihaz bip sesi çıkarır.

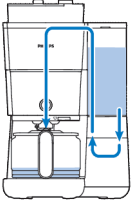

13 Fincanınızı veya kahve sürahisini cihazdan çıkarın.

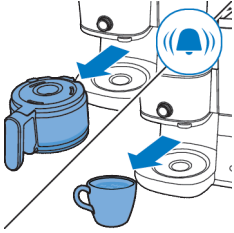

14 Taze demlenmiş kahvenizin keyfini çıkarın.





15 Cihazı kapatmak için başlat/duraklat düğmesini üç saniye basılı tutun.

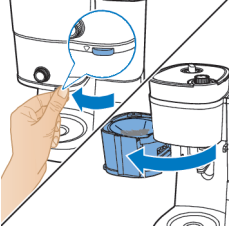

16 Filtre tutucusunu açın.

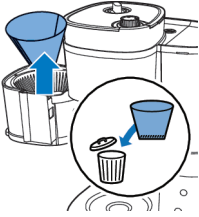

17 Kullanılmış kağıt filtreyi çıkarın.

Zamanlayıcıyı ayarlama

Cihazdaki zamanlayıcıyı ayarlamak için şu adımları izleyin:

- 1 Kahve makinesini açın.
- 2 Zamanlayıcı düğmesine bastığınızda ekranda zamanlayıcı simgesi görüntülenir. Saat haneleri, ayarlanan saati gösterecek şekilde yanıp söner.

08:06



08:00



- 3 Saati ayarlamak için ok düğmesini kullanın. Hızlı bir şekilde ayarlamaz gerekiyorsa ok düğmesine uzun basın.

08:



- 4 Saat ayarını onaylamak için zamanlayıcı düğmesine basın. Dakika haneleri, ayarlanan dakikayı belirtir.



08:05



- 5 Dakikayı ayarlamak için ok düğmesini tekrar kullanın. Hızlı bir şekilde ayarlamaz gerekiyorsa ok düğmesine uzun basın.

08:06



- 6 Dakika ayarını onaylamak için zamanlayıcı düğmesine tekrar basın.
Zamanlayıcıyı iptal etmek için zamanlayıcı düğmesine basmanız yeterlidir; zamanlayıcı simgesi ekrandan kaybolur.

Damlama önleme işlevi, kahve yapma işlemi tamamlanmadan önce sürahiyi kahve makinesinden çıkarmanıza olanak tanır. Damlama önleyici, sürahiyi çıkardığınızda sürahiye kahve akışını durdurur.

Not: Sürahiyi çıkardığınızda kahve demleme işlemi durmaz. Sürahiyi 20 saniye içinde cihaza geri koymazsanız filtre sepeti taşar.

Temizlik ve Bakım

Her kullanımdan sonra temizleme

Kahve makinesini kesinlikle suya veya başka bir sıvıya batırmayın ya da muslukta durulamayın.

1 Elektrik fişini prizden çekin.

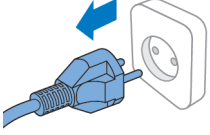







2 Kahve makinesinin dış kısmını nemli bir bezle silin.

3 Filtre sepetini sıcak su ve bulaşık deterjanı ile temizleyin ya da bulaşık makinesinde yıkayın.



4 Muslukta durulayarak kahve sürahisini ve kapağını temizleyin. Bunları bulaşık makinesinde de yıkayabilirsiniz.

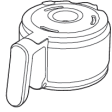
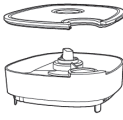

			
	✓	✓	✓
	✓	✓	✓
	✓	✓	✓
	✓	✗	✓
	✓	✗	✓

Öğütücü hunisini temizleme

Önemli:

Öğütücü hunisini, öğütülmüş kahveyle tıkanmasını önlemek için 1 ila 2 haftada bir temizleyin. Bu, aşağıdaki adımları uygulayarak kolay ve hızlı bir şekilde gerçekleştirilir.

Ekranda bir fırça uyarısı olduğunu fark ettiğinizde öğütücü hunisini temizleyin.

Not: Temizleme prosedürüne başlamadan önce kahve çekirdeği haznesinin boş olduğundan emin olun.

1 Cihazı prize takın.

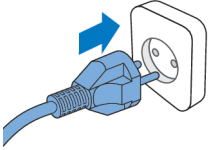

2 Öğütme hunisi kanalına erişmek için filtre tutucusunu açın.

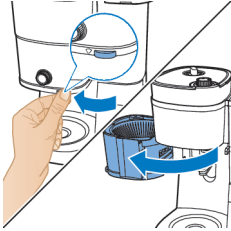

3 Kahve makinesini açın.

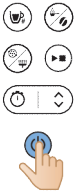

4 Makinenin kontrol panelindeki temizle düğmesine basın.

5 Ekrandan fırça ayarını seçin.





- 6 Başlat düğmesine basın. Bu, öğütme hunisi kanalı kapağının açılmasına neden olarak kanalı bir fırçayla temizlemenize olanak sağlar.

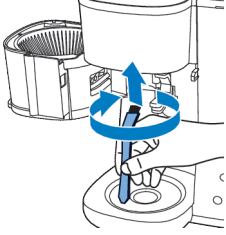

- 7 Kanalda birikmiş olabilecek kahve artıklarını veya kalıntıları fırçayla temizleyin.



- 8 Kanalı temizledikten sonra kapağı kapatmak için başlat düğmesine tekrar basın.

Kahve makinesinin kirecini temizleme

Ekranda kireç temizleme uyarısı görüntülendiğinde kahve makinesinin kirecini temizleyin. Kireci temizlemek için sadece beyaz sirke kullanın, aksi halde diğer ürünler kahve makinesine zarar verebilir.

Uyarı: Makinenin kirecini temizlemek için asla asetik asit içeriği %8 veya daha fazla olan sirke, doğal sirke, toz kireç çözücü veya tablet kireç çözücü kullanmayın, aksi halde bu ürünler hasara yol açabilir.

1 Su haznesinin kapağını açın.

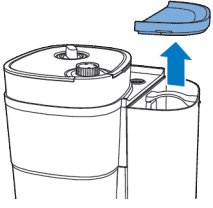

2 Su haznesini 10 fincan işareti kadar beyaz sirkeyle (%4 asetik asit) doldurun.

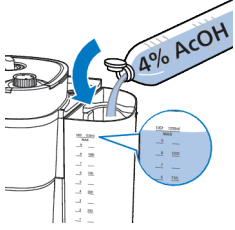

3 Su haznesinin kapağını kapatın.

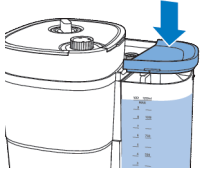

4 Filtre tutucusunu açmak için tırnağı tutun.

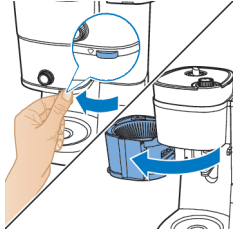

5 Kağıt filtreyi (tip 1x4 veya no. 4) filtre sepetine yerleştirin ve filtre sepeti tutucusunu kapatın.

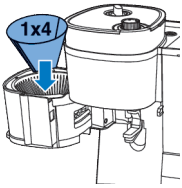

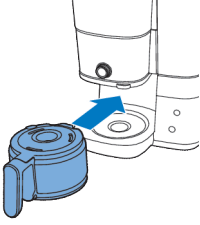

6 Boş sürahiyi kahve makinesine yerleştirin.

7 Elektrik fişini prize takın.

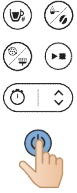

8 Güç düğmesine basarak kahve makinesini çalıştırın. Ekran açılır.

9 Kahve makinesindeki temizleme düğmesine basın.

10 Kireç temizleme ayarını seçin.

11 Seçiminizi doğrulamak için başlat düğmesine basın.

- Kahve makinesi kireç temizleme işlemine otomatik olarak başlar.

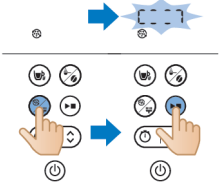

12 Makinenin kireç temizleme çözümüyle demleme işlemini bitirmesini bekleyin.

13 Kireç temizleme işlemi tamamlandıktan sonra, tüm birikintileri tamamen gidermek için makineyi iki kez maksimum miktarda suyla durulayın.

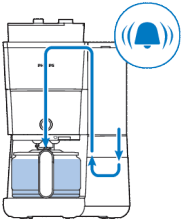

14 Sürahiyi boşaltın ve kireç kalıntıları bulunan kağıt filtreyi çıkarın.

15 Su haznesini temiz soğuk suyla doldurun ve başka bir kahve demleme işlemi başlatmak üzere başlat düğmesine basın.

Kahve makinesinin tüm kahve demleme işlemini tamamlamasını bekleyin ve sürahiyi boşaltın.

Not: Gerekirse kahve makinesinden çıkan suda sirke tadı veya kokusu kalmayana kadar 14. adımı tekrarlayın.

16 Filtre sepetini ve sürahiyi sıcak su ve bir miktar bulaşık deterjanıyla temizleyin.

17 Güç düğmesine basarak cihazı kapatın.

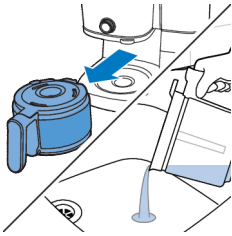

Sorun giderme

Bu bölümde makine ile ilgili en sık karşılaşılan sorunlar özetlenmiştir. Sorunu aşağıdaki bilgilerle çözemezseniz sık sorulan sorular listesi için www.philips.com/support adresini ziyaret edin veya ülkenizdeki Tüketici Destek Merkezi ile iletişime geçin.

Daha fazla çevrimiçi destek almak için bu QR kodunu da tarayabilirsiniz.



Sorun	Çözüm
Kahve makinesi çalışmıyor.	Elektrik fişini bir prize takın ve kahve makinesini açmak için açma/kapama düğmesine basın.
	Kahve makinesinde belirtilen gerilimin, konut şebeke gerilimiyle uyumlu olduğundan emin olun.
	Su haznesini suyla doldurun.
	Öğütücü hunisinin kapağını kapatın.
Öğütücü çalışmıyor veya düzgün çalışmıyor.	Önceden öğütülmüş kahveyi seçmediğinizden emin olun. Ekranda önceden öğütülmüş kahve simgesinin görünmesi, önceden öğütülmüş kahveyi seçtiğinizi gösterir.
	Talimatları izleyerek öğütücü hunisini temizleyin.
Öğütücüyü kullandığımda kahve çok hafif oluyor.	İnce ile kalın arasında istenen öğütme türünü seçmek için öğütme kalınlığı düğmesini çevirin.
	Kahve sertliğini 1 ile 3 arasında ayarlamak için sertlik seçme düğmesini kullanın. Daha büyük rakam, daha yüksek sertlik anlamına gelir.
	Daha sert karışımli veya daha güçlü aromalı kahve çekirdekleri kullanın.
Önceden öğütülmüş kahve kullandığımda kahve çok hafif oluyor.	Filtredeki önceden öğütülmüş kahve miktarının su haznesindeki su miktarıyla tutarlı olduğundan emin olun. Kahve makinesinin su haznesindeki tüm suyu kullandığını lütfen unutmayın.
	Daha sert karışımli veya daha güçlü aromalı öğütülmüş kahve kullanın.
	Kahve sertliğini artırmak için önceden öğütülmüş kahve miktarını artırın veya su miktarını azaltın.
Kahve demlenirken sürahiyi kahve makinesinden çıkardığımda filtre taşıyor.	Kahve yapma işlemi sırasında sürahiyi 20 saniyeden daha uzun süre çıkarırsanız damlama önleyici, filtre sepetinin taşmasına neden olur. Ayrıca kahve demleme işlemi sona ermeden kahvenin tam tadına ulaşmadığı da unutmayın. Bu nedenle kahve demleme işlemi sona ermeden önce sürahiyi çıkarmamanızı ve kahveyi boşaltmamanızı öneririz.

Kahve makinesi, kahve yapma işlemi bittikten uzun süre sonra damlamaya devam eder.	Damlama, buharın yoğunlaşması nedeniyle gerçekleşir. Kahve makinesinin bir süre damlaması tamamen normaldir.
Son birkaç damlayı bekleyemem.	Düğmeyi fincan modundan sürahi moduna çevirerek damlama önleme işlevini açın; damlama önleyici, filtre sepetinden damlamayı durdurur.
	Damlama durmuyorsa damlama önleyici tıkanmış olabilir. Damlama önleyiciyi temizlemek için filtre sepeti tutucusunu açın ve filtre sepetini çıkarın. Filtre sepetini ve damlama önleyiciyi musluk altında yıkayın.
Kahve yeterince sıcak değil.	Sadece birkaç fincan kahve hazırlarsanız sürahinin içindeki kahve daha hızlı soğur. Tam bir sürahiyi dolduracak şekilde 10 fincan hazırlarsanız kahve daha uzun süre sıcak kalır.
	Kahve makinesinin kirecini temizleyin.
Kahve çekirdekleri hızlı bir şekilde bitiyor.	Mükemmel bir fincan kahve hazırlamak için kahve makinesinin belirli miktarda öğütülmüş kahveye ihtiyacı vardır. Kahve makinesinin fincan başına en uygun öğütülmüş kahve miktarını elde etmek için kullandığı kahve çekirdeği miktarı normaldir.
Zamanlayıcı çalışmıyor.	Zamanlayıcıyı ayarlamadan önce, kahve çekirdekleri veya önceden öğütülmüş kahve ile kahve demlemek için tüm adımları tamamladığınızdan emin olun.

Hata kodu

Hata kodu	Tanım	Çözüm	Açıklama
E1	Su sıkıntısı	Cihazı bekleme moduna almak için herhangi bir düğmeye basın. Su haznesini yeniden doldurun ve cihazı yeniden başlatın.	Bu sorun devam ederse aşağıdaki adımları izleyin: Cihaz otomatik olarak bir dakika boyunca su pompalamaya başlayana kadar temizleme ve çalıştırma düğmesini aynı anda üç saniye boyunca basılı tutun. Bu işlemi 3 kez tekrarlayın. Sorun hâlâ devam ederse müşteri hizmetleriyle iletişime geçin.
E2	Kahve çekirdeği haznesi kullanılamıyor	Cihazı bekleme moduna almak için herhangi bir düğmeye basın. Kahve çekirdeği haznesini tam oturacak şekilde takın ve cihazı yeniden başlatın	Sorun devam ederse müşteri hizmetleriyle iletişime geçin.
E3	Isıtma borusu arızalı	Cihazın fişini çekin. Tamamen soğuyana kadar cihazı tekrar prize takın ve çalıştırın.	Sorun devam ederse müşteri hizmetleriyle iletişime geçin.

E4	Öğütme çarkının tıkanması	Cihazın fişini çekin. Cihazı tekrar prize takın ve açın. Öğütme çarkını ve öğütme hunisi kanalını temizlemek için "Öğütme hunisini temizleme" bölümündeki adımları izleyin.	Sorun devam ederse müşteri hizmetleriyle iletişime geçin.
E5	Öğütme hunisi kanalında tıkanma	Cihazın fişini çekin. Cihazı tekrar prize takın ve açın. Öğütme hunisi kanalını temizlemek için "Öğütücü hunisini temizleme" bölümündeki adımları izleyin.	Sorun devam ederse müşteri hizmetleriyle iletişime geçin.
E6/E7/E8	Program hatası	Cihazın fişini çekin. Cihazı tekrar prize takın ve açın.	Sorun devam ederse müşteri hizmetleriyle iletişime geçin.

Εισαγωγή

Συγχαρητήρια για την αγορά σας και καλώς ήρθατε στη Philips!

Για να επωφεληθείτε πλήρως από την υποστήριξη που προσφέρει η Philips, δηλώστε το προϊόν σας στη διεύθυνση www.philips.com/welcome.

Γενική περιγραφή

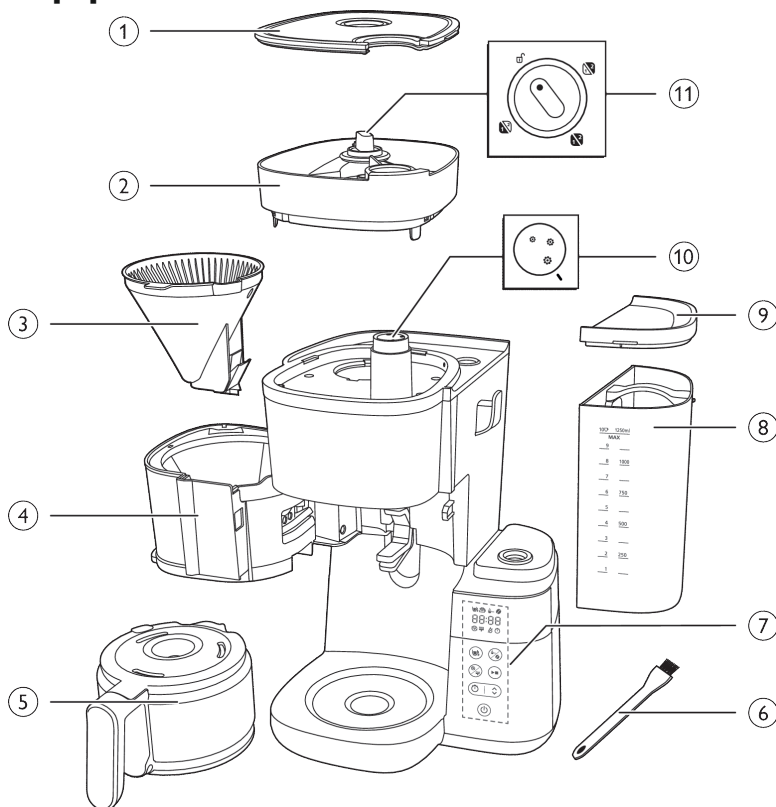

- 1 Καπάκι δοχείου κόκκων
- 2 Δοχείο κόκκων
- 3 Καλάθι φίλτρου
- 4 Υποδοχή καλαθιού φίλτρου
- 5 Γυάλινη κανάτα
- 6 Βουρτσάκι καθαρισμού υποδοχής κόκκων
- 7 Πίνακας ελέγχου με οθόνη
- 8 Δοχείο νερού
- 9 Καπάκι δοχείου νερού
- 10 Διακόπτης επιπέδου άλεσης
- 11 Διακόπτης επιλογής δοχείου

Πίνακας ελέγχου



Κουμπί ενεργοποίησης/απενεργοποίησης



Κουμπί χρονοδιακόπτη και κουμπί βέλους για ρύθμιση της ώρας



Κουμπί έναρξης/παύσης



Κουμπί καθαρισμού



Κουμπί αλεσμένου καφέ και έντασης καφέ



Κουμπί επιλογής φλιτζανιού

Εικονίδιο οθόνης



Αριθμός φλιτζανιών



Λειτουργία διατήρησης θερμοκρασίας



Αλεσμένος καφές



Ένταση του καφέ



Αφαίρεση αλάτων



Ειδοποίηση για αυτόματο καθαρισμό



Ενδειξη χαμηλής στάθμης νερού



Χρονοδιακόπτης



Εμφάνιση ώρας

Τα δύο πρώτα ψηφία αντιπροσωπεύουν τις ώρες και τα δύο τελευταία ψηφία αντιπροσωπεύουν τα λεπτά.



Γυρίστε το κουμπί στη θέση ξεκλειδώματος. Στη συνέχεια, μπορείτε να αφαιρέσετε το δοχείο κόκκων από τη συσκευή.



Αυτό το κουμπί επιλέγει το επίπεδο άλεσης καφέ, με το μεγαλύτερο μέγεθος να υποδεικνύει την πιο χοντρή άλεση.



Λειτουργία κανάτας

Η λειτουργία κανάτας διαθέτει λειτουργία προστασίας σταξίματος.

Σημείωση: Η διαδικασία παρασκευής δεν σταματά όταν αφαιρείτε την κανάτα. Αν δεν τοποθετήσετε την κανάτα πίσω στη συσκευή μέσα σε 20 δευτερόλεπτα, το καλάθι φίλτρου υπερχειλίζει.



Λειτουργία φλιτζανιού

Γυρίστε με μη αυτόματο τρόπο το κουμπί από τη λειτουργία φλιτζανιού στη λειτουργία κανάτας για να ενεργοποιήσετε τη διακοπή σταξίματος, ώστε να μην στάξει το νερό μόλις ολοκληρωθεί ο κύκλος παρασκευής καφέ.

Σημείωση: Οι κρύες κεραμικές κούπες αποσπούν θερμότητα από τον καφέ καθώς ζεσταίνεται το υλικό τους, γι' αυτό να τις προθερμαίνετε με ζεστό νερό.

Σημαντικό!

Προειδοποίηση

- Ελέγξτε αν η τάση που αναγράφεται στη συσκευή αντιστοιχεί στην τοπική τάση ρεύματος προτού συνδέσετε τη συσκευή.
- Να συνδέετε τη συσκευή σε πρίζα με γείωση.
- Μην χρησιμοποιείτε τη συσκευή αν το φις, το καλώδιο ή η ίδια η συσκευή έχει υποστεί φθορά.
- Αν το καλώδιο υποστεί φθορά, θα πρέπει να αντικατασταθεί από τη Philips, από κάποιο κέντρο επισκευών εξουσιοδοτημένο από τη Philips ή από εξίσου εξειδικευμένα άτομα, προς αποφυγή κινδύνου.
- Αυτή η συσκευή μπορεί να χρησιμοποιηθεί από παιδιά από 8 ετών και πάνω και από άτομα με περιορισμένες σωματικές, αισθητήριες ή διανοητικές ικανότητες ή από άτομα χωρίς εμπειρία και γνώση, με την προϋπόθεση ότι τη χρησιμοποιούν υπό επιτήρηση ή ότι έχουν λάβει οδηγίες σχετικά με την ασφαλή της χρήση και κατανοούν τους ενδεχόμενους κινδύνους. Τα παιδιά δεν πρέπει να καθαρίζουν και να συντηρούν τη συσκευή, παρά μόνο αν είναι ηλικίας άνω των 8 ετών και επιβλέπονται. Διατηρήστε τη συσκευή και το καλώδιό της μακριά από παιδιά ηλικίας κάτω των 8 ετών.
- Τα παιδιά δεν πρέπει να παίζουν με τη συσκευή.

- Μην αφήσετε το καλώδιο να κρέμεται από την άκρη του τραπεζιού ή του πάγκου πάνω στον οποίο έχετε τοποθετήσει τη συσκευή.
- Χρησιμοποιήστε τη συσκευή μόνο για τον σκοπό για τον οποίο προορίζεται, προς αποφυγή ενδεχόμενου κινδύνου ή τραυματισμού.

Προσοχή

- Να ξεπλένετε πάντα τη συσκευή με φρέσκο νερό πριν από την πρώτη χρήση.
- Μην τοποθετείτε τη συσκευή πάνω σε θερμές επιφάνειες και μην αφήνετε το καλώδιο ρεύματος να έρθει σε επαφή με θερμές επιφάνειες.
- Μην τοποθετείτε τη συσκευή σε ντουλάπι την ώρα που τη χρησιμοποιείτε.
- Αποσυνδέστε τη συσκευή από την πρίζα πριν την καθαρίσετε και αν προκύψουν προβλήματα κατά την παρασκευή του καφέ.
- Να καθαρίζετε πάντα τη συσκευή αφού πρώτα κρυώσει.
- Κατά την παρασκευή καφέ και τη λειτουργία διατήρησης θερμοκρασίας, το δοχείο νερού, η υποδοχή φίλτρου, η θερμαινόμενη πλάκα, το κάτω μέρος της συσκευής και η κανάτα που είναι γεμάτη με καφέ παραμένουν ζεστά ακόμα και μετά από λίγη ώρα.
- Μην τοποθετείτε την κανάτα σε συμβατικό φούρνο ή φούρνο μικροκυμάτων για να ζεσάτετε ξανά τον καφέ.
- Αυτή η συσκευή προορίζεται για χρήση στο σπίτι και σε παρόμοια περιβάλλοντα, όπως εξοχικά, πανσιόν, κουζίνες προσωπικού σε καταστήματα, γραφεία και άλλα εργασιακά περιβάλλοντα, καθώς και από πελάτες σε ξενοδοχεία, πανδοχεία και άλλα περιβάλλοντα που προσφέρουν υπηρεσίες διαμονής.
- Για έλεγχο ή επισκευή της συσκευής, να απευθύνεστε πάντα σε ένα εξουσιοδοτημένο κέντρο σέρβις της Philips. Μην ανοίξετε τη συσκευή και μην επιχειρήσετε να επισκευάσετε τη συσκευή μόνοι σας.
- Η επιφάνεια των αντιστάσεων, η υποδοχή φίλτρου, το κάτω μέρος της συσκευής, η θερμαινόμενη πλάκα και η κανάτα που είναι γεμάτη με καφέ μπορεί να παραμένουν ζεστές για κάποιο χρονικό διάστημα μετά τη χρήση.
- Εκτός αν αναγράφεται κάτι διαφορετικό, όλα τα υλικά συσκευασίας στο κουτί είναι κατασκευασμένα από ανακυκλωμένο χαρτί. Ανατρέξτε στη σήμανση PAP στο κουτί.

Αφαίρεση αλάτων

- Αφαιρέστε τα άλατα από την καφετιέρα όταν παρατηρήσετε ότι στην οθόνη εμφανίζεται μια ειδοποίηση αφαίρεσης αλάτων. Να χρησιμοποιείτε μόνο λευκό ξίδι για να την αφαίρεση αλάτων, καθώς άλλα προϊόντα μπορεί να προκαλέσουν ζημιά στη συσκευή.

Ηλεκτρομαγνητικά πεδία (EMF)

Η συγκεκριμένη συσκευή της Philips συμμορφώνεται με τα πρότυπα που αφορούν τα ηλεκτρομαγνητικά πεδία (EMF).

Ανακύκλωση



Αυτό το σύμβολο υποδεικνύει ότι το παρόν προϊόν δεν πρέπει να απορριφθεί μαζί με τα συνηθισμένα απορρίμματα του σπιτιού σας (2012/19/ΕΕ).

Ακολουθήστε τους κανονισμούς της χώρας σας για την ξεχωριστή συλλογή των ηλεκτρικών και ηλεκτρονικών προϊόντων. Η σωστή απόρριψη συμβάλλει στην αποφυγή αρνητικών επιπτώσεων για το περιβάλλον και την ανθρώπινη υγεία.

Εκτός αν αναγράφεται κάτι διαφορετικό, όλα τα υλικά συσκευασίας στο κουτί είναι κατασκευασμένα από ανακυκλωμένο χαρτί. Ανατρέξτε στη σήμανση PAP στο κουτί.

Εγγύηση και υποστήριξη

Η Versuni παρέχει εγγύηση δύο ετών μετά την αγορά αυτού του προϊόντος. Η παρούσα εγγύηση δεν ισχύει αν το ελάττωμα οφείλεται σε εσφαλμένη χρήση ή κακή συντήρηση. Η εγγύησή μας δεν επηρεάζει τα νομικά σας δικαιώματα ως καταναλωτή. Για περισσότερες πληροφορίες ή για να ενεργοποιήσετε την εγγύηση, επισκεφθείτε τη διαδικτυακή μας τοποθεσία www.philips.com/support.

Πριν την πρώτη χρήση

Φροντίστε να καθαρίζετε την υποδοχή φίλτρου και το μόνιμο φίλτρο μετά από κάθε χρήση.

Σκουπίστε καλά την υποδοχή φίλτρου με ένα στεγνό πανί μετά από κάθε χρήση. Φροντίστε να την καθαρίζετε από τυχόν συμπυκνωμένους υδρατμούς.

Ρύθμιση ρολογιού

- 1 Συνδέστε τη συσκευή στην πρίζα.
 - Η ένδειξη ώρας θα αρχίσει να αναβοσβήνει.

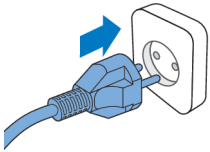

08:00



- 2 Χρησιμοποιήστε το κουμπί βέλους για να ρυθμίσετε την ώρα.

08: (🔔)



- 3 Μόλις ρυθμιστεί η ώρα, πιάστε το κουμπί του χρονοδιακόπτη για να επιβεβαιώσετε την ώρα.

08:06



- 4 Η ένδειξη λεπτών θα αρχίσει να αναβοσβήνει. Χρησιμοποιήστε το κουμπί βέλους για να ρυθμίσετε τα λεπτά.

08:06 (🔔)



- 5 Πατήστε το κουμπί του χρονοδιακόπτη για να επιβεβαιώσετε τα λεπτά.



08:06

- Η τρέχουσα ώρα έχει ρυθμιστεί και αποθηκευτεί.
- 6 Για να ρυθμίσετε τον χρονοδιακόπτη σε λειτουργία αναμονής, μπορείτε να επιλέξετε μεταξύ δύο παρακάτω προσεγγίσεων:
 - Αποσυνδέστε τη συσκευή και συνδέστε την ξανά στην πρίζα.
 - Πατήστε παρατεταμένα το κουμπί του χρονοδιακόπτη μέχρι να αρχίσουν να αναβοσβήνουν τα ψηφία της ώρας.

Σημείωση

Η συσκευή αποθηκεύει πάντα την τελευταία ρύθμιση.

Χρόνος διατήρησης θερμοκρασίας

Μπορείτε να επιλέξετε το χρονικό διάστημα για το οποίο θέλετε ο καφές σας να παραμένει ζεστός μετά την παρασκευή, προσαρμόζοντας το χρονικό διάστημα μετά την αυτόματη απενεργοποίηση της συσκευής. Ο προεπιλεγμένος χρόνος αυτόματης απενεργοποίησης είναι 30 λεπτά. Ο μέγιστος χρόνος αυτόματης απενεργοποίησης είναι 300 λεπτά.

Για να ρυθμίσετε την ώρα αυτόματης απενεργοποίησης, ακολουθήστε τα παρακάτω βήματα:

- 1 Απενεργοποιήστε τη συσκευή και διατηρήστε την συνδεδεμένη στο ρεύμα.
- 2 Πατήστε παρατεταμένα το κουμπί καθαρισμού μέχρι να εμφανιστεί το εικονίδιο διατήρησης θερμοκρασίας και να αρχίσει να αναβοσβήνει η ώρα.

- 3 Ακολουθήστε το βήμα στην ενότητα "Ρύθμιση του ρολογιού" για να ολοκληρώσετε τη ρύθμιση.

Καθαρισμός της συσκευής με νερό

Ξυπλύνετε την καφετιέρα μία φορά πριν από την πρώτη χρήση, ακολουθώντας τα παρακάτω βήματα.

Προειδοποίηση: Μην ρίχνετε ποτέ νερό μέσα στο δοχείο κόκκων, καθώς μπορεί να προκληθεί ζημιά στην καφετιέρα.

- 1 Ανοίξτε το καπάκι του δοχείου νερού.

Προσοχή: Μην βάζετε κόκκους καφέ ή αλεσμένο καφέ στο δοχείο νερού

- 2 Μπορείτε να γεμίσετε το δοχείο με νερό με οποιονδήποτε από τους παρακάτω τρόπους:

- Σηκώστε το δοχείο από τη συσκευή και τοποθετήστε το κάτω από τη βρύση για να το γεμίσετε με νερό.

- Όταν το επιστρέψετε στη θέση του, βεβαιωθείτε ότι το άγκιστρο έχει τοποθετηθεί σωστά.
- Πιάστε το κούμπωμα του καπακιού για να τραβήξετε προς τα πάνω το καπάκι της κανάτας. Τοποθετήστε την κανάτα καφέ κάτω από τη βρύση για να την γεμίσετε με νερό. Γεμίστε το δοχείο νερού με την κανάτα καφέ.
- Βεβαιωθείτε ότι η στάθμη του νερού βρίσκεται κάτω από την ένδειξη μέγιστης στάθμης.

- 3 Κλείστε το καπάκι δοχείου νερού.

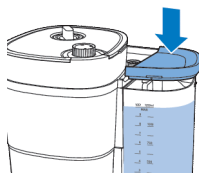
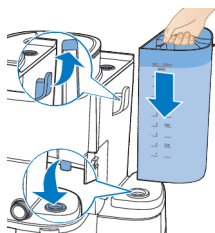
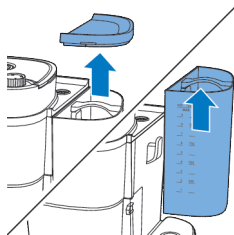

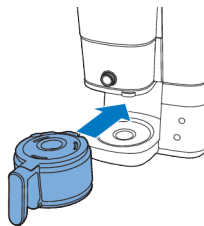

4 Τοποθετήστε την κανάτα καφέ στη συσκευή.

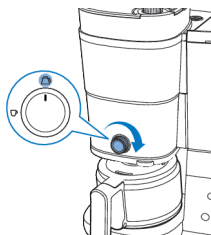

5 Περιστρέψτε τον κεντρικό διακόπτη στη ρύθμιση κανάτας.



6 Πατήστε το κουμπί ενεργοποίησης/απενεργοποίησης.
- Η συσκευή ενεργοποιείται.



7 Πιέστε το κουμπί έντασης καφέ και επιλέξτε αλεσμένο καφέ.

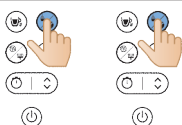

8 Πατήστε το κουμπί φλιτζανιού και επιλέξτε 10 φλιτζάνια.

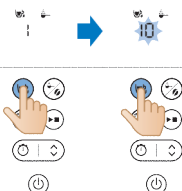



9 Πατήστε το κουμπί έναρξης.

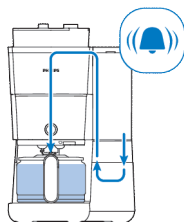

10 Η συσκευή ξεκινά τη διαδικασία καθαρισμού με νερό.

11 Αφήστε τη συσκευή να λειτουργήσει μέχρι να ολοκληρωθεί η διαδικασία καθαρισμού με νερό.

12 Αδειάστε τη γυάλινη κανάτα.



Χρήση της συσκευής

Χρήση των κόκκων καφέ

Σημείωση: η καφετιέρα θα χρησιμοποιήσει την απαιτούμενη ποσότητα νερού με βάση τον αριθμό φλιτζανιών καφέ που πρέπει να παρασκευαστούν

Ακολουθήστε τα παρακάτω βήματα για να χρησιμοποιήσετε τη συσκευή:

1 Ανοίξτε το καπάκι του δοχείου νερού και σηκώστε το δοχείο από τη συσκευή.

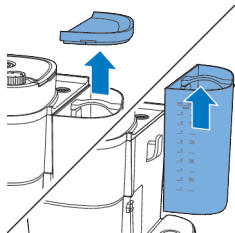



- 2 Γεμίστε το δοχείο με νερό από τη βρύση.
- Βεβαιωθείτε ότι η στάθμη του νερού βρίσκεται κάτω από τη μέγιστη στάθμη.

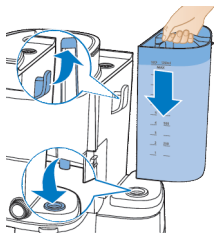

- 3 Τοποθετήστε ξανά το δοχείο στη συσκευή.
- Βεβαιωθείτε ότι το άγκιστρο έχει συνδεθεί σωστά.

- 4 Κλείστε το καπάκι του δοχείου νερού.

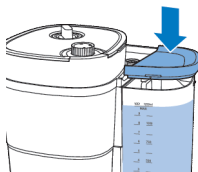

- 5 Ανασηκώστε το καπάκι του δοχείου κόκκων.

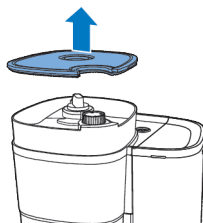

- 6 Προσθέστε τους κόκκους καφέ της προτίμησής σας στο δοχείο.

Σημείωση: Να βεβαιώνετε πάντα ότι το δοχείο κόκκων Fresh Bean Duo είναι γεμάτο τουλάχιστον κατά το ήμισυ.

Προειδοποίηση: Για να μην φράξει ο μύλος, μην χρησιμοποιείτε ακαβούρδιστους ή καραμελωμένους κόκκους. Χρησιμοποιήστε κόκκους καφέ αντί για κόκκους εσπρέσο, καθώς οι κόκκοι εσπρέσο μπορεί να προκαλέσουν ζημιά στο μύλο.

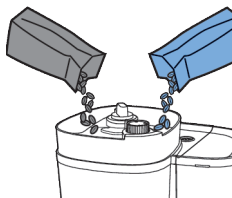

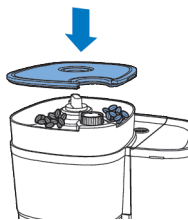

7 Κλείστε το καπάκι του δοχείου κόκκων.

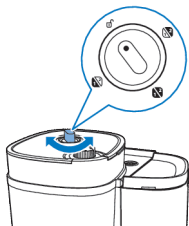

8 Γυρίστε τον διακόπτη επιλογής δοχείου για να επιλέξετε τους επιθυμητούς κόκκους ανάμεσα στα δύο δοχεία.

- Μπορείτε ακόμη και να αναμείξετε δύο διαφορετικά είδη κόκκων για ένα μοναδικό μείγμα.

Σημείωση: Κάθε φορά που κάνετε εναλλαγή μεταξύ δοχείων κόκκων καφέ ή κόκκων καφέ, θα υπάρχουν πάντα ίχνη από το προηγούμενο είδος κόκκων καφέ. Για να το αποφύγετε αυτό, καθαρίστε το στόμιο του μύλου μετά την αλλαγή.

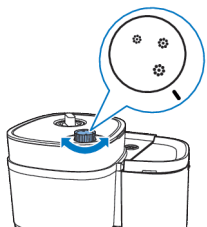

9 Επιλέξτε το επιθυμητό επίπεδο άλεσης χρησιμοποιώντας τον διακόπτη.

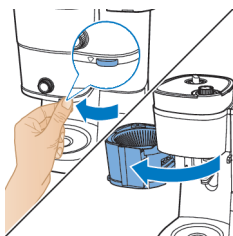

10 Πιάστε το κούμπωμα για να ανοίξετε την υποδοχή φίλτρου.

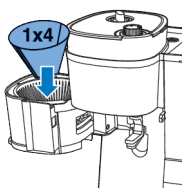

11 Τοποθετήστε ένα χάρτινο φίλτρο (τύπου 1x4 ή νούμερο 4) στο καλάθι του φίλτρου.

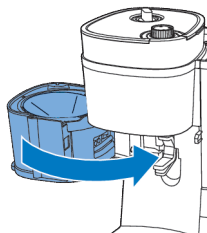

12 Κλείστε την υποδοχή φίλτρου

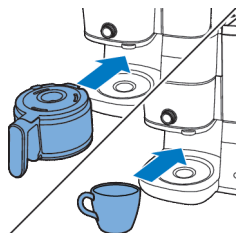

13 Τοποθετήστε την κανάτα του καφέ ή το φλιτζάνι σας κάτω από τον διανομέα.

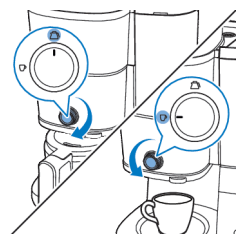

14 Χρησιμοποιήστε το διακόπτη για να επιλέξετε την ποσότητα καφέ που θέλετε να φτιάξετε.

Όταν χρησιμοποιείτε τη λειτουργία παρασκευής καφέ σε φλιτζάνι, μπορείτε να χρησιμοποιήσετε είτε γυάλινες είτε κεραμικές κούπες, καθώς και ποτήρια. Βεβαιωθείτε ότι χρησιμοποιείτε φλιτζάνια με ύψος μικρότερο από 10 εκ.

☰ 3



15 Ενεργοποιήστε τη συσκευή.

☰ 3



16 Επιλέξτε τον αριθμό φλιτζανιών που θέλετε να φτιάξετε πατώντας το κουμπί φλιτζανιού.



17 Πιέστε το κουμπί έντασης για να επιλέξετε την επιθυμητή ένταση του καφέ.

- 1: Κόκκοι για καφέ με ήπια ένταση
- 2: Κόκκοι για καφέ με μέτρια ένταση
- 3: Κόκκοι για καφέ με δυνατή ένταση



18 Ξεκινήστε τη διαδικασία πατώντας το κουμπί έναρξης/παύσης.

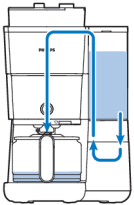

19 Η συσκευή ξεκινά την επεξεργασία.

- Η συσκευή θα παραγάγει ένα ηχητικό σήμα όταν ολοκληρωθεί η διαδικασία.

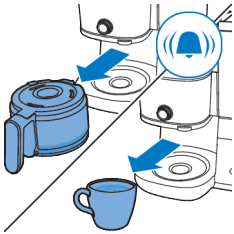

20 Αφαιρέστε το φλιτζάνι ή την κανάτα καφέ από τη συσκευή.

Η λειτουργία προστασίας σταξίματος σάς επιτρέπει να αφαιρέσετε την κανάτα από την καφετιέρα πριν ολοκληρωθεί η διαδικασία παρασκευής. Όταν αφαιρείτε την κανάτα, η λειτουργία προστασίας σταξίματος σταματά τη ροή του καφέ στην κανάτα.

Η διαδικασία παρασκευής δεν σταματά όταν αφαιρείτε την κανάτα. Αν δεν τοποθετήσετε την κανάτα πίσω στη συσκευή μέσα σε 20 δευτερόλεπτα, το καλάθι φίλτρου υπερχειλίζει.



21 Απολαύστε τον φρέσκο καφέ σας.

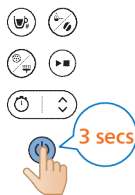

22 Για να απενεργοποιήσετε τη συσκευή, πατήστε παρατεταμένα το κουμπί έναρξης/παύσης για τρία δευτερόλεπτα.

23 Ανοίξτε την υποδοχή φίλτρου.

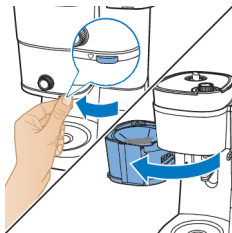

24 Αφαιρέστε το χρησιμοποιημένο χαρτινό φίλτρο.

Η λειτουργία διατήρησης θερμοκρασίας δεν ενεργοποιείται κατά την παρασκευή ενός ή δύο 2 φλιτζανιών.

Η συσκευή θα διατηρήσει το ρόφημά σας ζεστό μέχρι να απενεργοποιηθεί αυτόματα. Αν δεν θέλετε να κρατήσετε ζεστό το ρόφημά σας, πατήστε το κουμπί ενεργοποίησης/απενεργοποίησης για να απενεργοποιήσετε τη συσκευή.

Χρήση αλεσμένου καφέ

Ακολουθήστε τα παρακάτω βήματα για να χρησιμοποιήσετε τη συσκευή:

1 Βεβαιωθείτε ότι η συσκευή έχει αρκετό νερό για να παρασκευάσει την επιθυμητή ποσότητα καφέ.

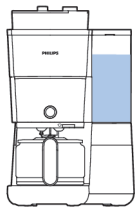

2 Πιάστε το κούμπωμα για να ανοίξετε την υποδοχή φίλτρου.

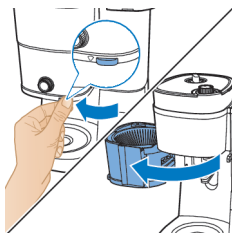

- 3** Τοποθετήστε ένα χαρτίνο φίλτρο (τύπου 1x4 ή νούμερο 4) στο καλάθι φίλτρου.

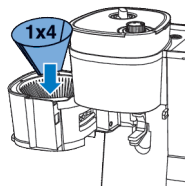

- 4** Προσθέστε την ποσότητα αλεσμένου καφέ στο χαρτίνο φίλτρο που χρησιμοποιείτε ανάλογα με τις προσωπικές σας προτιμήσεις.
- Για ένα κανονικό φλιτζάνι καφέ, χρησιμοποιήστε 6 γραμμάρια αλεσμένου καφέ ή 1 κουταλιά της σούπας.

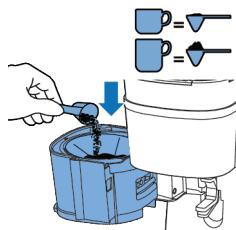

- 5** Κλείστε την υποδοχή φίλτρου.

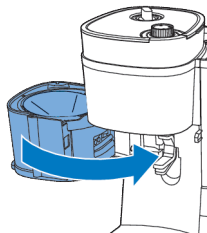

- 6** Τοποθετήστε την κανάτα του καφέ ή το φλιτζάνι σας κάτω από τον διανομέα.

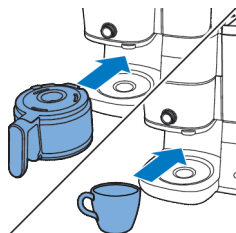

- 7** Χρησιμοποιήστε το διακόπτη για να επιλέξετε την ποσότητα καφέ που θέλετε να φτιάξετε.

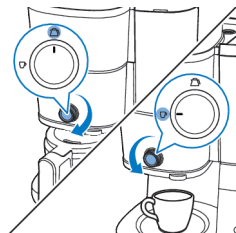



8 Ενεργοποιήστε τη συσκευή.



9 Επιλέξτε να χρησιμοποιήσετε αλεσμένο καφέ πατώντας το κουμπί επιλογής λειτουργίας.

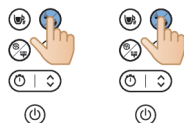

10 Επιλέξτε τον αριθμό φλιτζανιών που θέλετε να φτιάξετε πατώντας το κουμπί φλιτζανιού.

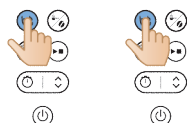

11 Ξεκινήστε τη διαδικασία πατώντας το κουμπί έναρξης/παύσης.



12 Η συσκευή ξεκινά την επεξεργασία.

- Η συσκευή θα παραγάγει ένα ηχητικό σήμα όταν ολοκληρωθεί η διαδικασία.

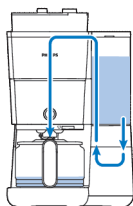

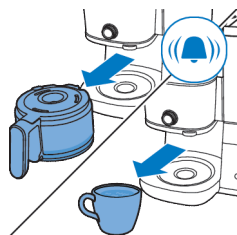

13 Αφαιρέστε το φλιτζάνι ή την κανάτα καφέ από τη συσκευή.



14 Απολαύστε τον φρέσκο καφέ σας.



15 Για να απενεργοποιήσετε τη συσκευή, πατήστε παρατεταμένα το κουμπί έναρξης/παύσης για τρία δευτερόλεπτα.



16 Ανοίξτε την υποδοχή φίλτρου.

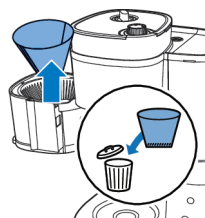

17 Αφαιρέστε το χρησιμοποιημένο χάρτινο φίλτρο.

Ρύθμιση χρονοδιακόπτη

Για να ρυθμίσετε τον χρονοδιακόπτη στη συσκευή, ακολουθήστε τα παρακάτω βήματα:

- 1 Ανάψτε την καφετιέρα.
- 2 Πατήστε το κουμπί του χρονοδιακόπτη. Στην οθόνη θα εμφανιστεί το εικονίδιο του χρονοδιακόπτη. Τα ψηφία της ώρας αναβοσβήνουν για να υποδείξουν τη ρύθμιση της ώρας.

08:06



08:00



08:



08:06



- 3 Χρησιμοποιήστε το κουμπί βέλους για να ρυθμίσετε τις ώρες. Αν θέλετε να κάνετε γρήγορα τη ρύθμιση, πατήστε παρατεταμένα το κουμπί βέλους.

- 4 Πιέστε το κουμπί του χρονοδιακόπτη για να επιβεβαιώσετε τη ρύθμιση της ώρας. Τα ψηφία των λεπτών υποδεικνύουν τη ρύθμιση των λεπτών.

- 5 Χρησιμοποιήστε ξανά το κουμπί βέλους για να ρυθμίσετε τα λεπτά. Αν θέλετε να κάνετε γρήγορα τη ρύθμιση, πατήστε παρατεταμένα το κουμπί βέλους.

00:05



- 6 Πατήστε ξανά το κουμπί του χρονοδιακόπτη για να επιβεβαιώσετε τη ρύθμιση των λεπτών.

Για να ακυρώσετε τον χρονοδιακόπτη, πατήστε απλώς το κουμπί του χρονοδιακόπτη. Το εικονίδιο του χρονοδιακόπτη θα εξαφανιστεί από την οθόνη.

Η λειτουργία προστασίας σταξίματος σάς επιτρέπει να αφαιρέσετε την κανάτα από την καφετιέρα πριν ολοκληρωθεί η διαδικασία παρασκευής. Όταν αφαιρείτε την κανάτα, η λειτουργία προστασίας σταξίματος σταματά τη ροή του καφέ στην κανάτα.

Σημείωση: Η διαδικασία παρασκευής δεν σταματά όταν αφαιρείτε την κανάτα. Αν δεν τοποθετήσετε την κανάτα πίσω στη συσκευή μέσα σε 20 δευτερόλεπτα, το καλάθι φίλτρου υπερχειλίζει.

Καθαρισμός και συντήρηση

Καθαρισμός μετά από κάθε χρήση

Μην βυθίζετε ποτέ την καφετιέρα σε νερό ή σε οποιοδήποτε άλλο υγρό και μην την ξεπλένετε με νερό βρύσης.

- 1 Αποσυνδέστε το βύσμα από την πρίζα.

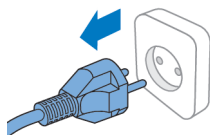









- 2 Σκουπίστε το εξωτερικό της καφετιέρας με ένα υγρό πανί.
3 Καθαρίστε το καλάθι φίλτρου με ζεστό νερό και λίγο υγρό απορρυπαντικό ή μέσα στο πλυντήριο πιάτων.



- 4 Καθαρίστε την κανάτα και το καπάκι ξεπλένοντας κάτω από τη βρύση. Μπορείτε επίσης να τα βάλετε στο πλυντήριο πιάτων.

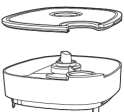

			
	✓	✓	✓
	✓	✓	✓
	✓	✓	✓
	✓	✗	✓
	✓	✗	✓

Καθαρισμός του στόμιου του μύλου

Σημαντικό:

Να καθαρίζετε το στόμιο του μύλου κάθε 1 με 2 εβδομάδες, για να αποφεύγετε τη συσσώρευση αλεσμένου καφέ. Η διαδικασία είναι εύκολη και γρήγορη. Ακολουθήστε τα παρακάτω βήματα.

Καθαρίστε το στόμιο του μύλου όταν παρατηρήσετε ότι εμφανίζεται στην οθόνη μια ειδοποίηση με βουρτσάκι.

Σημείωση: Βεβαιωθείτε ότι το δοχείο κόκκων είναι άδειο πριν ξεκινήσετε τη διαδικασία καθαρισμού.

- 1 Συνδέστε τη συσκευή στην πρίζα.

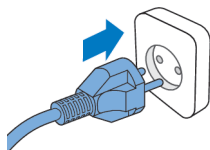

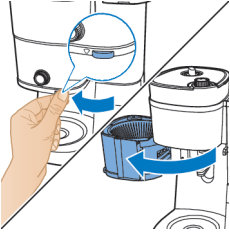

- 2** Ανοίξτε την υποδοχή φίλτρου για να αποκτήσετε πρόσβαση στο στόμιο υποδοχής αλεσμένου καφέ.

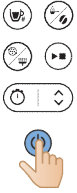

- 3** Ανάψτε την καφετιέρα.

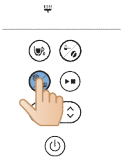

- 4** Πατήστε το κουμπί καθαρισμού στον πίνακα ελέγχου του μηχανήματος.
5 Επιλέξτε τη ρύθμιση με το βουρτσάκι στην οθόνη.

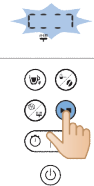

- 6** Πατήστε το κουμπί έναρξης. Αυτό θα ανοίξει το κάλυμμα του στομίου υποδοχής αλεσμένου καφέ, επιτρέποντάς σας να καθαρίσετε την υποδοχή με ένα βουρτσάκι.

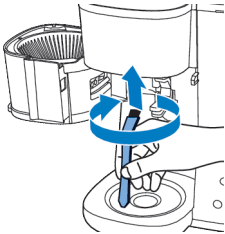

- 7** Χρησιμοποιήστε το βουρτσάκι για να αφαιρέσετε τυχόν αλεσμένο καφέ ή υπολείμματα καφέ που μπορεί να έχουν συσσωρευτεί στην υποδοχή.



- 8 Αφού καθαρίσετε την υποδοχή, πατήστε ξανά το κουμπί έναρξης για να κλείσετε το κάλυμμα.

Αφαλάτωση της καφετιέρα

Αφαιρέστε τα άλατα από την καφετιέρα όταν παρατηρήσετε ότι στην οθόνη εμφανίζεται μια ειδοποίηση αφαίρεσης αλάτων. Να χρησιμοποιείτε μόνο λευκό ξίδι για να αφαιρέσετε τα άλατα, καθώς άλλα προϊόντα μπορεί να προκαλέσουν ζημιά στην καφετιέρα.

Προειδοποίηση: Μην χρησιμοποιείτε ποτέ ξίδι με περιεκτικότητα οξικού οξέος 8% ή μεγαλύτερη, φυσικό ξίδι, αφαλατικά σε σκόνη ή σε ταμπλέτες για να αφαιρέσετε τα άλατα από την καφετιέρα, καθώς μπορεί να προκληθεί βλάβη.

- 1 Ανοίξτε το καπάκι του δοχείου νερού.

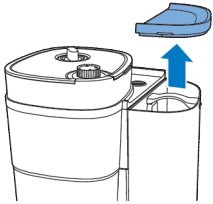

- 2 Γεμίστε το δοχείο νερού με λευκό ξίδι (4% ακετικό οξύ) μέχρι την ένδειξη των 10 φλιτζανιών.

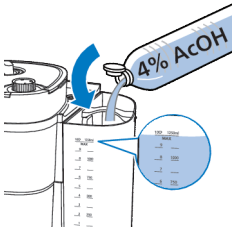

3 Κλείστε το καπάκι του δοχείου νερού.

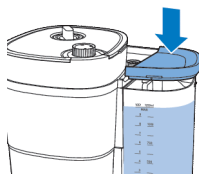

4 Πιάστε το κούμπωμα για να ανοίξετε την υποδοχή φίλτρου.

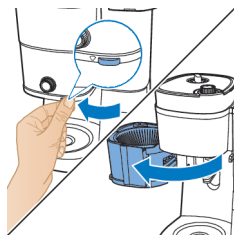

5 Τοποθετήστε ένα χαρτίνο φίλτρο (τύπου 1x4 ή νούμερο 4) στο καλάθι φίλτρου και κλείστε την υποδοχή του καλαθιού φίλτρου.

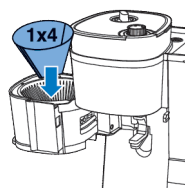

6 Τοποθετήστε την άδεια κανάτα στην καφετιέρα.

7 Βάλτε το φισ στην πρίζα.

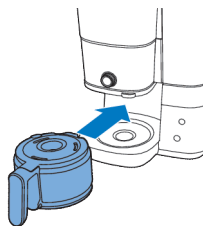

8 Πατήστε το κουμπί λειτουργίας για να ανάψετε την καφετιέρα. Η οθόνη φωτίζεται.

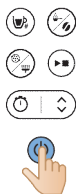

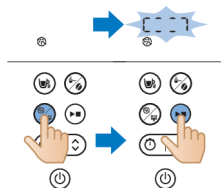

- 9 Πατήστε το κουμπί καθαρισμού στην καφετιέρα.
 10 Επιλέξτε τη ρύθμιση αφαλάτωσης.
 11 Πατήστε το κουμπί έναρξης για να επιβεβαιώσετε την επιλογή σας.
 - Η καφετιέρα θα ξεκινήσει αυτόματα τη διαδικασία αφαλάτωσης.

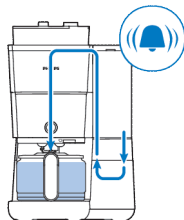

- 12 Περιμένετε μέχρι η καφετιέρα να ολοκληρώσει την αφαλάτωση.
 13 Μόλις ολοκληρωθεί η διαδικασία αφαλάτωσης, ξεπλύνετε την καφετιέρα δύο φορές με τη μέγιστη ποσότητα νερού, για να απομακρυνθούν εντελώς τυχόν υπολείμματα.

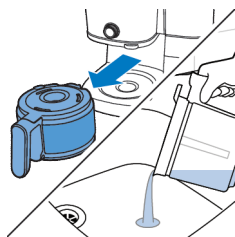

- 14 Αδειάστε την κανάτα και αφαιρέστε το χάρτινο φίλτρο με τα υπολείμματα αλάτων.
 15 Γεμίστε το δοχείο νερού με φρέσκο κρύο νερό και πατήστε το κουμπί έναρξης για να ξεκινήσετε μια νέα διαδικασία παρασκευής.
 Αφήστε την καφετιέρα να ολοκληρώσει ολόκληρη τη διαδικασία παρασκευής και αδειάστε την κανάτα.

Σημείωση: Αν είναι απαραίτητο, επαναλάβετε το βήμα 14 μέχρι το νερό που βγαίνει από τη καφετιέρα να μην μυρίζει πλέον ξίδι.

- 16 Καθαρίστε το καλάθι φίλτρου και την κανάτα με ζεστό νερό και λίγο υγρό απορρυπαντικό.
 17 Πατήστε το κουμπί λειτουργίας για να απενεργοποιήσετε τη συσκευή.

Αντιμετώπιση προβλημάτων

Σε αυτό το κεφάλαιο συνοψίζονται τα πιο συχνά προβλήματα που μπορεί να αντιμετωπίσετε με τη καφετιέρα σας. Αν δεν μπορείτε να λύσετε το πρόβλημα με τις παρακάτω πληροφορίες, ανατρέξτε στη λίστα συχνών ερωτήσεων στη διεύθυνση www.philips.com/support ή επικοινωνήστε με το Κέντρο Εξυπηρέτησης Καταναλωτών στη χώρα σας.

Μπορείτε επίσης να σαρώσετε αυτόν τον κωδικό QR για περισσότερη ηλεκτρονική υποστήριξη.



Πρόβλημα

Λύση

Η καφετιέρα δεν λειτουργεί. Συνδέστε το βύσμα στην πρίζα και πατήστε το κουμπί ενεργοποίησης/απενεργοποίησης για να ανάψετε την καφετιέρα.

Βεβαιωθείτε ότι η τάση που αναγράφεται στην καφετιέρα αντιστοιχεί στην τοπική τάση ρεύματος.

Γεμίστε το δοχείο με νερό βρύσης.

Κλείστε το καπάκι του στομίου του μύλου.

Ο μύλος δεν λειτουργεί καθόλου ή δεν λειτουργεί σωστά.

Βεβαιωθείτε ότι δεν έχετε επιλέξει αλεσμένο καφέ. Αν το σύμβολο αλεσμένου καφέ είναι ορατό στην οθόνη, έχετε επιλέξει αλεσμένο καφέ.

Καθαρίστε το στόμιο του μύλου ακολουθώντας τις οδηγίες.

Όταν χρησιμοποιείτε τον μύλο, ο καφές είναι πολύ ελαφρύς.

Γυρίστε τον διακόπτη επιπέδου άλεσης για να επιλέξετε τον επιθυμητό τύπο άλεσης από λεπτή σε χοντρή.

Χρησιμοποιήστε το κουμπί επιλογής έντασης για να ρυθμίσετε την ένταση του καφέ από το 1 έως το 3, όπου το μεγαλύτερο ψηφίο δηλώνει μεγαλύτερη ένταση.

Χρησιμοποιήστε κόκκους καφέ από πιο δυνατό χαρμάνι ή με πιο έντονη γεύση.

Όταν χρησιμοποιείτε αλεσμένο καφέ, ο καφές είναι πολύ ελαφρύς.

Βεβαιωθείτε ότι η ποσότητα του αλεσμένου καφέ στο φίλτρο είναι αντιστοιχη με την ποσότητα νερού στο δοχείο νερού. Να θυμάστε ότι η καφετιέρα χρησιμοποιεί όλο το νερό που υπάρχει στο δοχείο νερού.

Χρησιμοποιήστε αλεσμένο καφέ από πιο δυνατό χαρμάνι ή με πιο έντονη γεύση.

Για να αυξήσετε την ένταση του καφέ, αυξήστε την ποσότητα αλεσμένου καφέ ή μειώστε την ποσότητα του νερού.

Το φίλτρο υπερχειλίζει όταν απομακρύνετε την κανάτα από την καφετιέρα ενώ παρασκευάζεται ο καφές.

Αν αφαιρέσετε την κανάτα για περισσότερο από 20 δευτερόλεπτα κατά τη διάρκεια της διαδικασίας παρασκευής, η λειτουργία προστασίας σταξίματος προκαλεί υπερχειλίση του καλαθιού φίλτρου. Να θυμάστε, επίσης, ότι ο καφές δεν έχει αποκτήσει ολοκληρωμένη γεύση πριν ολοκληρωθεί η διαδικασία παρασκευής. Επομένως, σας συνιστούμε να μην αφαιρέσετε την κανάτα και να μην σερβίρετε τον καφέ πριν ολοκληρωθεί η διαδικασία παρασκευής.

Η καφετιέρα συνεχίζει να στάζει για μεγάλο χρονικό διάστημα μετά την ολοκλήρωση της διαδικασίας παρασκευής.

Το στάξιμο προκαλείται από συμπίκνωση του ατμού. Είναι απόλυτα φυσιολογικό η καφετιέρα να στάζει για λίγη ώρα.

Ανυπομονείτε να πιείτε τον καφέ σας.

Γυρίστε τον διακόπτη από τη λειτουργία φλιτζανιού στη λειτουργία κανάτας για να ενεργοποιήσετε τη λειτουργία προστασίας σταξίματος, η οποία θα σταματήσει το στάξιμο από το καλάθι φίλτρου.

Αν η συσκευή δεν σταματήσει να στάζει, η προστασία σταξίματος ενδεχομένως να έχει φράξει. Για να καθαρίσετε την προστασία σταξίματος, ανοίξτε την υποδοχή καλαθιού φίλτρου και αφαιρέστε το καλάθι φίλτρου. Ξεπλύνετε το καλάθι φίλτρου και την προστασία σταξίματος κάτω από τη βρύση.

Ο καφές δεν είναι αρκετά ζεστός.

Αν παρασκευάζετε λίγα μόνο φλιτζάνια καφέ, ο καφές στην κανάτα κρυώνει πιο γρήγορα. Ο καφές παραμένει ζεστός για περισσότερη ώρα αν παρασκευάσετε 10 φλιτζάνια, ποσότητα που αντιστοιχεί σε μία γεμάτη κανάτα.

Αφαλάτωση της μηχανής καφέ.

Οι κόκκοι καφέ φαίνεται να εξαντλούνται γρήγορα.

Για να παρασκευάσετε ένα τέλειο φλιτζάνι καφέ, η καφετιέρα χρειάζεται μια ορισμένη ποσότητα αλεσμένου καφέ. Η ποσότητα κόκκων καφέ που χρησιμοποιεί η καφετιέρα για την επίτευξη της βέλτιστης ποσότητας αλεσμένου καφέ ανά φλιτζάνι είναι φυσιολογική.

Ο χρονοδιακόπτης δεν λειτουργεί.

Πριν ρυθμίσετε τον χρονοδιακόπτη, βεβαιωθείτε ότι έχετε ολοκληρώσει όλα τα βήματα για την παρασκευή καφέ με κόκκους ή αλεσμένου καφέ.

Κωδικός σφάλματος

Κωδικός σφάλματος	Περιγραφή	Λύση	Παρατήρηση
E1	Έλλειψη νερού	Πατήστε οποιοδήποτε κουμπί για να θέσετε τη συσκευή σε κατάσταση αναμονής. Ξαναγεμίστε το δοχείο νερού και επανεκκινήστε τη συσκευή.	Αν το πρόβλημα παραμένει, ακολουθήστε τα παρακάτω βήματα: Πατήστε το κουμπί καθαρισμού και το κουμπί έναρξης ταυτόχρονα για τρία δευτερόλεπτα, μέχρι η συσκευή να αρχίσει αυτόματα να αντλεί νερό για ένα λεπτό. Επαναλάβετε αυτή τη διαδικασία 3 φορές. Αν το πρόβλημα παραμένει, επικοινωνήστε με την εξυπηρέτηση πελατών.
E2	Το δοχείο κόκκων δεν είναι διαθέσιμο	Πατήστε οποιοδήποτε κουμπί για να θέσετε τη συσκευή σε κατάσταση αναμονής. Τοποθετήστε το δοχείο κόκκων με ασφάλεια και επανεκκινήστε τη συσκευή	Αν το πρόβλημα παραμένει, επικοινωνήστε με την εξυπηρέτηση πελατών.
E3	Ο σωλήνας θέρμανσης δεν λειτουργεί κανονικά	Αποσυνδέστε τη συσκευή από την πρίζα. Συνδέστε και ενεργοποιήστε ξανά τη συσκευή μέχρι να κρυώσει εντελώς.	Αν το πρόβλημα παραμένει, επικοινωνήστε με την εξυπηρέτηση πελατών.
E4	Απόφραξη μύλου άλεσης	Αποσυνδέστε τη συσκευή από την πρίζα. Συνδέστε και ενεργοποιήστε ξανά τη συσκευή. Ακολουθήστε τα βήματα στην ενότητα "Καθαρισμός του στομίου του μύλου" για να καθαρίσετε τον μύλο άλεσης και το στόμιο υποδοχής αλεσμένου καφέ.	Αν το πρόβλημα παραμένει, επικοινωνήστε με την εξυπηρέτηση πελατών.

E5	Απόφραξη στομίου υποδοχής αλεσμένου καφέ	Αποσυνδέστε τη συσκευή από την πρίζα. Συνδέστε και ενεργοποιήστε ξανά τη συσκευή. Ακολουθήστε τα βήματα στην ενότητα "Καθαρισμός του στομίου του μύλου" για να καθαρίσετε το στόμιο υποδοχής αλεσμένου καφέ.	Αν το πρόβλημα παραμένει, επικοινωνήστε με την εξυπηρέτηση πελατών.
E6/E7/ E8	Σφάλμα προγράμματος	Αποσυνδέστε τη συσκευή από την πρίζα. Συνδέστε και ενεργοποιήστε ξανά τη συσκευή.	Αν το πρόβλημα παραμένει, επικοινωνήστε με την εξυπηρέτηση πελατών.

Въведение

Поздравления за покупката и добре дошли във Philips!

За да се възползвате изцяло от предлаганата от Philips поддръжка, регистрирайте продукта си на www.philips.com/welcome.

Общо описание

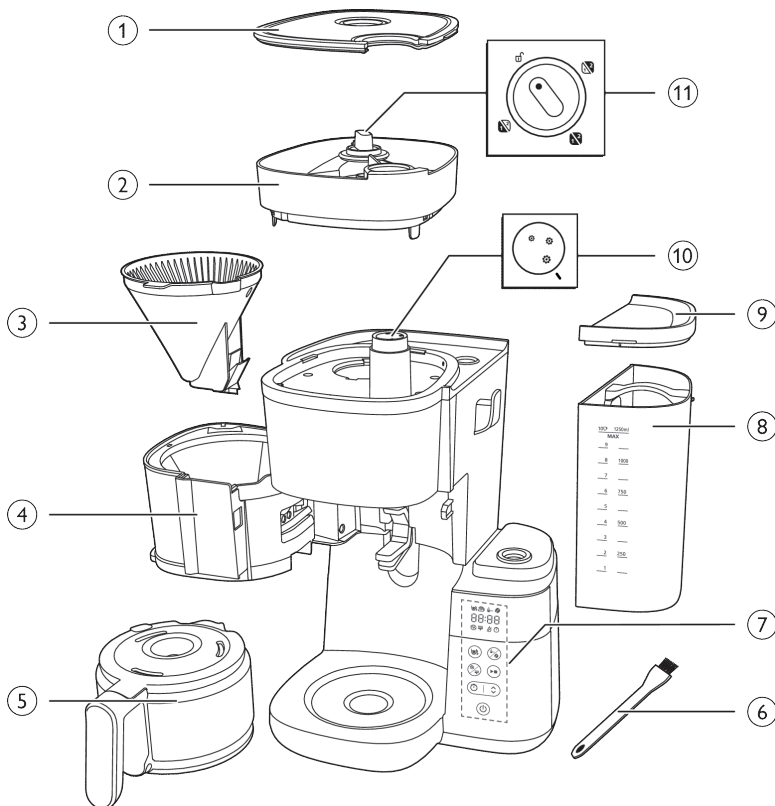

- 1 Капак на контейнера за кафе на зърна
- 2 Контейнер за кафе на зърна
- 3 Поставка за филтър
- 4 Държач на поставката за филтър
- 5 Стъклена кана
- 6 Четка за почистване на улея за кафе на зърна
- 7 Контролен панел с дисплей
- 8 Воден резервоар
- 9 Капак на водния резервоар
- 10 Копче за вид смилане на кафето
- 11 Бутон за избор на контейнер

Контролен панел



Бутон за захранване



Бутон за таймер и бутон със стрелка за регулиране на времето



Бутон за старт/пауза



Бутон за почистване



Бутон за мляно кафе и сила на кафето



Бутон за избор на чаша

Икона на дисплея



Брой чаши



Режим за поддържане на топлината



Мляно кафе



Сила на кафето



Премахване на накип



Предупреждение за ръчно почистване



Ниско ниво на водния резервоар



Таймер



Дисплей за продължителност

Първите две цифри представляват часовете, а последните две цифри представляват минутите.



Завъртете копчето в отключена позиция, след което можете да премахнете съдържанието на кафе на зърна от уреда.



Този бутон избира вида смилане на кафето, като по-големият размер показва по-едро смилане.



Режим на кана

Функцията за спиране на капенето съществува в режим на кана.

Забележка: Процесът на приготвяне не спира, когато премахнете каната. Ако не поставите каната обратно в уреда в рамките на 20 секунди, поставката за филтър ще прелее.



Режим на чаша

Ръчно превключете копчето от режим на чаша в режим на кана, за да активирате функцията за спиране на капенето, за да предотвратите капенето, след като цикълът на приготвяне приключи

Забележка: Студената керамична чаша ще абсорбира топлина от кафето, тъй като се затопля от него – моля предварително затоплете чашата с гореща вода.

Важно

Предупреждение

- Преди да включите уреда в контакта, проверете дали посоченото на уреда напрежение отговаря на това на местната ел. захранваща мрежа.
- Включвайте уреда само в заземен електрически контакт.
- Не използвайте уреда, ако щепселът, захранващият кабел или самият уред са повредени.
- С оглед предотвратяване на опасност, при повреда в захранващия кабел той трябва да бъде сменен от Philips, оторизиран от Philips сервиз или квалифициран техник.
- Този уред може да се използва от деца на възраст над 8 години и от хора с намалени физически, сензорни или умствени способности или без опит и познания, ако са под наблюдение или са инструктирани за безопасна употреба на уреда и са разбрали евентуалните опасности. Почистване и поддръжка на уреда може да се извършва от деца на възраст над 8 години и под родителски надзор. Пазете уреда и захранващия кабел далече от достъп на деца на възраст под 8 години.
- Не позволявайте на деца да си играят с уреда.

- Не оставяйте захранващия кабел да виси през ръба на масата или стойката, на която е поставен уредът.
- Използвайте този уред само по предназначение, за да избегнете потенциална опасност или нараняване.

Внимание

- Винаги изплаквайте уреда с прясна вода преди първата употреба.
- Не поставяйте уреда върху гореща повърхност и пазете захранващия кабел от допиране до горещи повърхности.
- Не поставяйте уреда в шкаф, когато го използвате.
- Изключвайте уреда от контакта, преди да пристъпите към почистване, както и ако възникнат проблеми при варенето.
- Винаги почиствайте уреда, след като уредът се охлади.
- По време на приготвяне и поддържане на топлината водният резервоар, държачът на филтъра, нагревателната плоча, долната част на уреда и пълната с кафе кана са горещи дори известно време след това.
- Не поставяйте каната върху котлон или в микровълнова фурна, за да нагрявате повторно кафето.
- Този уред е предназначен за използване за домакински и подобни цели, например във ферми, в места за ношуване и закуска, в кухненски зони за персонала в магазини, в офиси и други работни помещения, както и от клиенти в хотели, мотели и други подобни помещения от жилищен тип.
- За проверка или ремонт носете уреда в упълномощен от Philips сервиз. Не отваряйте уреда и не се опитвайте сами да ремонтирате уреда.
- Повърхността на нагревателния елемент, държачът на филтъра, долната част на уреда, нагревателната плоча и пълната с кафе кана са подложени на остатъчна топлина за известно време след употреба.
- Освен ако не е посочено друго, всички опаковъчни материали в кутията са изработени от рециклирана хартия; вижте маркировката PAP върху кутията.

Премахване на накип

- Отстранете накипа от кафемашината, когато забележите, че на дисплея се появява предупреждение за премахване на накип. Използвайте само бял оцет за премахване на накип, тъй като други продукти могат да повредят уреда.

Електромагнитни полета (EMF)

Този уред на Philips е в съответствие със стандартите по отношение на електромагнитни полета (EMF).

Рециклиране



Този символ означава, че продуктът не може да се изхвърля заедно с обикновените битови отпадъци (2012/19/ЕС).

Следвайте правилата на държавата си относно разделното събиране на електрическите и електронните уреди. Правилното изхвърляне помага за предотвратяването на потенциални негативни последици за околната среда и човешкото здраве.

Освен ако не е посочено друго, всички опаковъчни материали в кутията са изработени от рециклирана хартия; вижте маркировката PAP върху кутията.

Гаранция и поддръжка

Versuni предлага двегодишна гаранция след покупката на този продукт. Тази гаранция не е валидна, ако дефектът се дължи на неправилна употреба или лоша поддръжка. Нашата гаранция не засяга правата ви по закон като потребител. За повече информация или за позоваване на гаранцията посетете нашия уебсайт www.philips.com/support.

Преди първата употреба

Почиствайте държача на филтъра и постоянния филтър след всяка употреба.

Забърсвайте държача на филтъра старателно със суха кърпа след всяка употреба. Не забравяйте да го почистите от натрупан конденз.

Свервяване на часовника

- 1 Включете щепсела на уреда в контакта.
- Индикацията за час ще започне да мига.

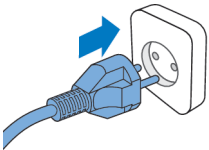

08:00



- 2 Използвайте бутона със стрелка, за да настроите часа.

08: 

- 3 След като часът е зададен, натиснете бутона за таймер, за да потвърдите часа.

08:06



- 4 Индикацията за минути ще започне да мига. Използвайте бутона със стрелка, за да настроите минутите.

08:06 

- 5 Натиснете бутона за таймер, за да потвърдите минутите.



08:06

- Текущото време вече е зададено и запазено.
- 6 За да настроите таймера в режим на готовност, можете да избирате между два подхода по-долу:
- Изключете уреда от контакта и включете отново.
 - Натиснете и задръжете бутона за таймера, докато цифрите на часа започнат да мигат.

Забележка

Уредът винаги запазва последната настройка.

Време за поддържане на топлината

Можете да изберете колко дълго искате кафето ви да се поддържа горещо след приготвянето, като регулирате времето, след което уредът автоматично да се изключва. Времето за автоматично изключване по подразбиране е 30 минути. Максималното време за автоматично изключване е 300 минути.

За да регулирате времето за автоматично изключване, следвайте стъпките по-долу:

- 1 Изключете уреда и го дръжте включен в контакта.
- 2 Натиснете и задръжете бутона за почистване, докато се покаже иконата на функцията за поддържане на топлината и започне да мига индикацията за час.

- 3 Следвайте стъпките в "Настройка на часовника", за да завършите настройката.

Промиване на уреда

Винаги промивайте кафемашината веднъж преди първата употреба, като следвате стъпките по-долу.

Предупреждение: Никога не наливайте вода в контейнера за кафе на зърна, тъй като това уврежда кафемашината.

- 1 Отворете капака на водния резервоар.

Внимание: Не слагайте във водния резервоар кафе на зърна или мляно кафе

- 2 Можете да напълните водния резервоар с вода по който и да е от начините по-долу:

- Повдигнете резервоара от уреда и го поставете под чешмата, за да напълните с вода.

- Уверете се, че куката е закрепена правилно, когато поставяте обратно.
- Хванете ушенцето на капака, за да издърпате капака на каната. Поставете каната за кафе под чешмата, за да напълните с вода. Напълнете водния резервоар с каната за кафе.
- Уверете се, че водата е под максималното ниво.

- 3 Затворете капака на водния резервоар.

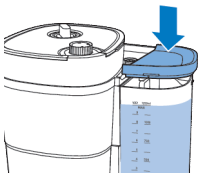
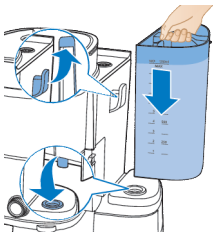
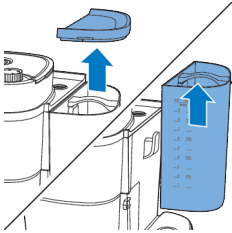

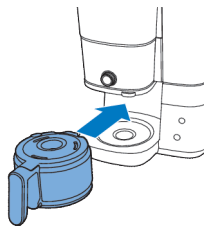

4 Поставете каната за кафе в уреда.

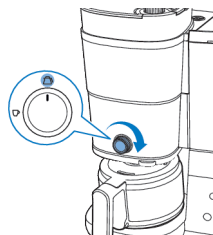

5 Завъртете бутона по средата до настройката за кана.



6 Натиснете бутона за включване/изключване.
- Уредът е включен.



7 Натиснете бутона за сила на кафето и изберете опцията за мляно кафе.

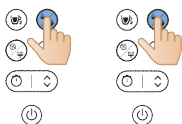

8 Натиснете бутона за чаша и изберете 10 чаши.

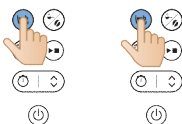

9 Натиснете бутона старт.

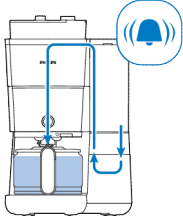

10 Уредът стартира процеса на промиване.

11 Оставете уредът да работи, докато процесът по промиване приключи.



12 Изпразнете стъклената кана.

Използване на уреда

Използване на кафе на зърна

Забележка: кафемашината ще използва необходимото количество вода на базата на брой чаши кафе, които трябва да се приготвят

Следвайте стъпките по-долу, за да използвате:

1 Отворете капака на водния резервоар и повдигнете резервоара от уреда.

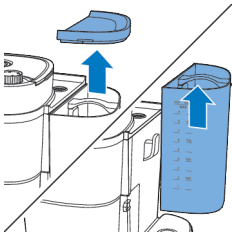

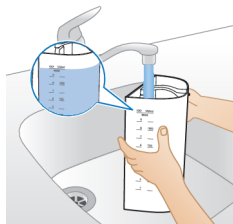

- 2 Напълнете резервоара с вода от чешмата.
- Уверете се, че водата не надвишава максималното ниво.

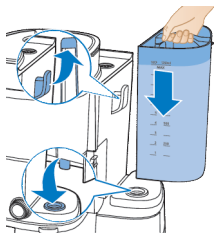

- 3 Сложете резервоара обратно в уреда.
- Уверете се, че куката е правилно прикрепена.

- 4 Затворете капака на водния резервоар.

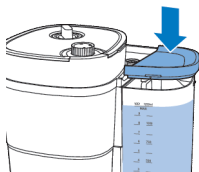

- 5 Повдигнете капака на контейнера за кафе на зърна.

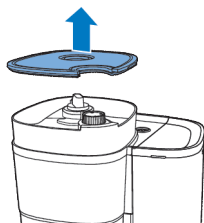

- 6 Добавете желаното кафе на зърна в контейнера.

Забележка: Винаги се уверявайте, че отделението за свежи зърна кафе на двойния контейнер за кафе на зърна е пълно поне наполовина.

Предупреждение: За да избегнете задръстване на мелачката, не използвайте сурови или карамелизирани зърна кафе. Използвайте кафе на зърна вместо зърна еспreso, тъй като зърната еспreso може да повредят мелачката.

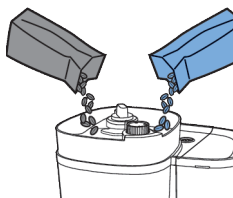

7 Затворете капака на контейнера за кафе на зърна.

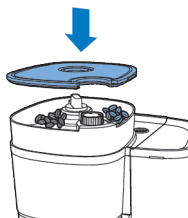

8 Завъртете бутона за избор на контейнер, за да изберете желаните зърна от двата контейнера.

- Можете дори да смесите два различни вида зърна за уникална смес.

Забележка: Винаги когато превключвате между контейнери за кафе на зърна или зърна кафе, ще има следи от кафе, останали от предишния млян вид кафе на зърна. Почистете фунията на мелачката, след като преминете към нов вид кафе на зърна, за да предотвратите това.

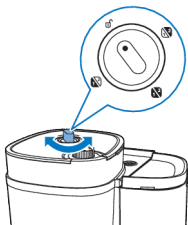

9 Изберете желаното ниво на смилане с помощта на копчето.

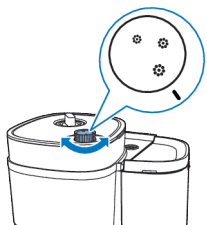

10 Хванете ушенцето, за да отворите държача на филтъра.

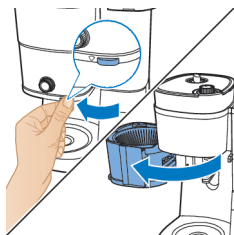

11 Поставете хартиен филтър (тип 1 x 4 или № 4) в поставката за филтър.

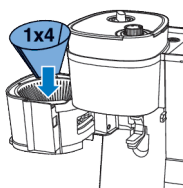

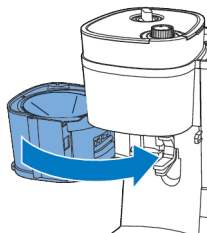

12 Затворете филтърния държач

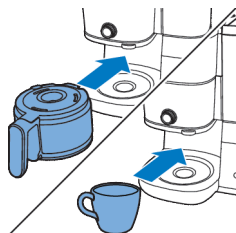

13 Поставете каната за кафе или чашата си под дозатора.

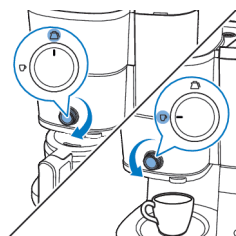

14 Използвайте бутона, за да изберете количеството кафе, което искате да направите.

Когато използвате функцията за приготвяне в чаша, можете да използвате стъклени или керамични чаши. Уверете се, че използвате чаши с височина по-малка от 10 см.

10 3

15 Включете уреда.



10 3

16 Изберете броя чаши за приготвяне, като натиснете бутона за чаша.





17 Натиснете бутона за сила, за да изберете предпочитаната от вас сила на кафето.

- 1: зърна за по-слабо кафе
- 2: зърна за средно по сила кафе
- 3: зърна за силно кафе



18 Започнете процеса, като натиснете бутона за старт/пауза.



19 Уредът започва обработката.

- Уредът ще издаде звуков сигнал, когато е готов.

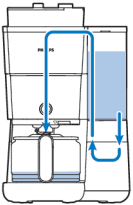

20 Премахнете чашата или каната за кафе от уреда.

Функцията за спиране на капенето ви позволява да извадите каната от кафемашината, преди процесът на приготвяне да приключи. Когато извадите каната, функцията за спиране на капенето спира потока на кафето в каната.

Процесът на приготвяне не спира, когато премахнете каната. Ако не поставите каната обратно в уреда в рамките на 20 секунди, поставката за филтър ще прелее.

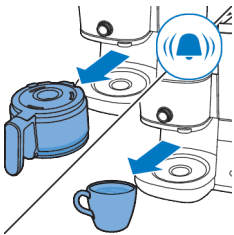

21 Насладете се на прясно пригответеното кафе.



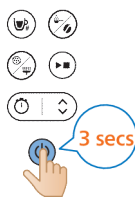

22 За да изключите уреда, натиснете и задръжте бутона за старт/пауза за три секунди.

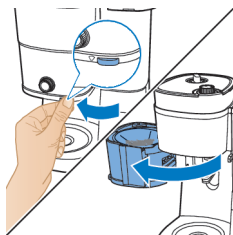

23 Отворете държача на филтъра.

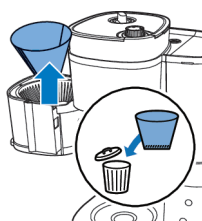

24 Отстранете използвания хартиен филтър.

Функцията за поддържане на топлината не се активира при приготвяне на една или две чаши.

Вашият уред ще поддържа напитката ви гореща, докато се изключи автоматично. Ако не искате напитката ви да остава гореща повече, натиснете бутона за включване/изключване, за да изключите уреда.

Използване на мляно кафе

Следвайте стъпките по-долу, за да използвате:

1 Проверете дали уредът има достатъчно вода, за да направите желаното количество кафе.

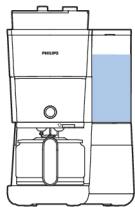

2 Хванете ушенцето, за да отворите държача на филтъра.

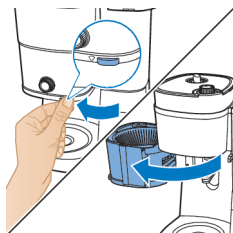

- 3 Поставете хартиен филтър (тип 1 x 4 или № 4) в поставката за филтър.

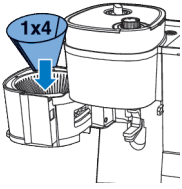

- 4 Добавете желаното количество мляно кафе в хартиения филтър в зависимост от предпочитанията си.
 - За стандартна чаша кафе използвайте 6 грама мляно кафе или 1 супена лъжица.

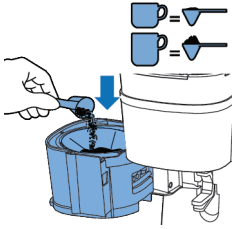

- 5 Затворете държача на филтъра.

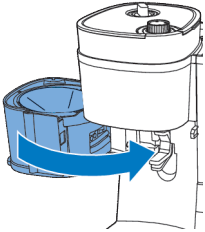

- 6 Поставете каната за кафе или чашата си под дозатора.

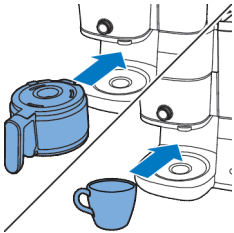

- 7 Използвайте бутона, за да изберете количеството кафе, което искате да направите.

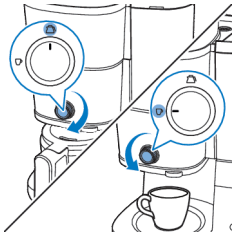



8 Включете уреда.



9 Изберете да използвате мляно кафе, като натиснете бутона за избор на режим.

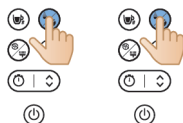

10 Изберете броя чаши за приготвяне, като натиснете бутона за чаша.

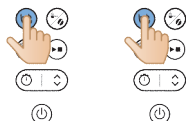

11 Започнете процеса, като натиснете бутона за старт/пауза.



12 Уредът започва обработката.

- Уредът ще издаде звуков сигнал, когато е готов.

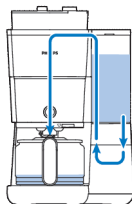

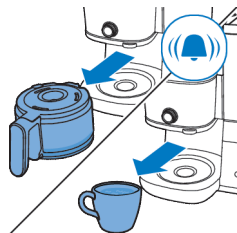

13 Премахнете чашата или каната за кафе от уреда.



14 Насладете се на прясно приготвеното кафе.



15 За да изключите уреда, натиснете и задръжте бутона за старт/пауза за три секунди.

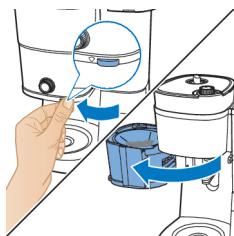

16 Отворете държача на филтъра.

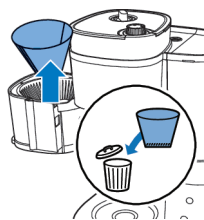

17 Отстранете използвания хартиен филтър.

Настройване на таймера

За да зададете таймера на уреда, изпълнете следните стъпки:

- 1 Включете кафемашината.
- 2 Натиснете бутона за таймер и иконата за таймер ще се появи на дисплея. Цифрите за часа мигат, за да покажат настройването на часа.

08:06 

08:00



- 3 Използвайте бутона със стрелка, за да настроите часовете. Можете по-бързо да настроите часа, като натиснете бутона със стрелка за по-дълго.

08: 

- 4 Натиснете бутона за таймера, за да потвърдите часа. Цифрите на минутите показват настройването на минутите.

08:06



- 5 Използвайте бутона със стрелка отново, за да настроите минутите. Можете по-бързо да настроите часа, като натиснете бутона със стрелка за по-дълго.

08:05



- 6 Натиснете отново бутона за таймера, за да потвърдите настройката на минутите.

За да отмените таймера, просто натиснете бутона за таймера и иконата за таймер ще изчезне от дисплея.

Функцията за спиране на капенето ви позволява да извадите каната от кафемашината, преди процесът на приготвяне да приключи. Когато извадите каната, функцията за спиране на капенето спира потока на кафето в каната.

Забележка: Процесът на приготвяне не спира, когато премахнете каната. Ако не поставите каната обратно в уреда в рамките на 20 секунди, поставката за филтър ще прелее.

Почистване и поддръжка

Почистване след всяка употреба

Никога не потапяйте кафемашината във вода или друга течност и не я мийте с течаща вода.



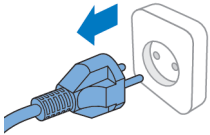





- 1 Изключете щепсела от контакта.



- 2 Избършете външността на кафемашината с влажна кърпа.
3 Почистете филтърната кошница с гореща вода и малко течен миеш препарат или ги почистете в съдомиялна машина.

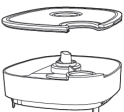

- 4 Почистете каната за кафе и капака, като изплакнете под течаща вода. Можете също и да ги почистите в съдомиялната машина.

			
	✓	✓	✓
	✓	✓	✓
	✓	✓	✓
	✓	✗	✓
	✓	✗	✓

Почистване на фунията на мелачката

Важно:

Почиствайте фунията на мелачката на всеки 1 до 2 седмици, за да предотвратите запушване със смляно кафе. Това е лесно и бързо, като следвате стъпките по-долу.

Почистете фунията на мелачката, когато забележите, че на дисплея се появява предупреждение с четка.

Забележка: Уверете се, че контейнерът за кафе на зърна е празен, преди да започнете процедурата по почистване.

- 1 Включете щепсела на уреда в контакта.

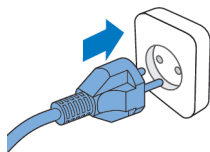

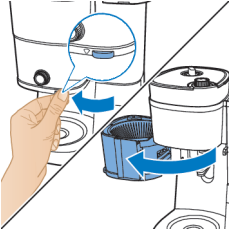

- 2 Отворете държача на филтъра, за да получите достъп до улея на фунията за смяно кафе.

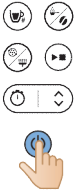

- 3 Включете кафемашината.

- 4 Натиснете бутона за почистване на контролния панел на машината.
5 Изберете настройката с четка на екрана.



- 6 Натиснете бутона старт. Това ще доведе до отваряне на капачето на улея на фунията за смяно кафе, което ще ви позволи да почистите улея с четка.



- 7 Използвайте четка, за да отстраните утайка от кафе или остатъци, които може да са се натрупали в улея.

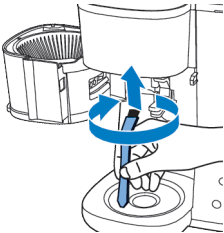



- 8 След почистване на улея натиснете отново бутона за стартиране, за да затворите капачето.

Премахване на накипа на кафемашината

Отстранете накипа от кафемашината, когато забележите, че на дисплея се появява предупреждение за премахване на накип. Използвайте само бял оцет за премахване на накип, тъй като други продукти могат да повредят кафемашината.

Предупреждение: Никога не използвайте оцет с 8% или повече съдържание на оцетна киселина, нито естествен оцет или препарати за премахване на накип на прах или таблетки, тъй като това може да причини повреда в машината.

- 1 Отворете капака на водния резервоар.

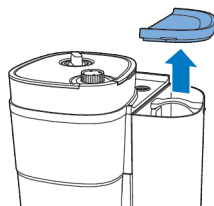

- 2 Напълнете водния резервоар с бял оцет (4% оцетна киселина) до индикацията за 10 чаши.

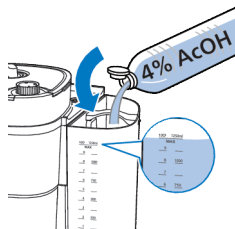

- 3 Затворете капака на водния резервоар.

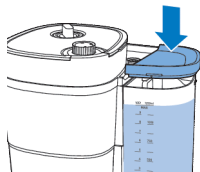

- 4 Хванете ушенцето, за да отворите държача на филтъра.

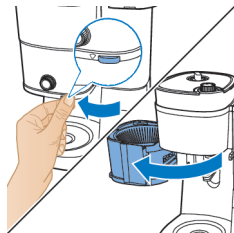

- 5 Поставете хартиен филтър (тип 1 x 4 или № 4) в поставката за филтър и затворете държача на поставката за филтър.

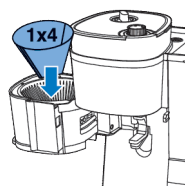

- 6 Поставете празната кана в кафемашината.

- 7 Включете щепсела на захранващия кабел в контакта.

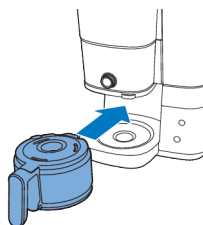

- 8 Натиснете бутона за захранване, за да включите кафемашината. Дисплеят светва.

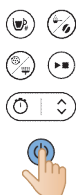

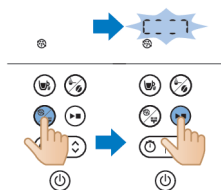

9 Натиснете бутона за почистване на кафемашината.

10 Изберете настройката за премахване на накип.

11 Натиснете бутона за старт, за да потвърдите избора си.

- Кафемашината автоматично ще започне процеса на отстраняване на накип.

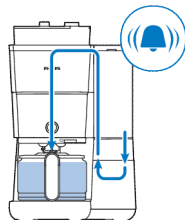

12 Изчакайте машината да завърши приготвянето на разтвора за отстраняване на накип.

13 След като процесът на отстраняване на накип приключи, изплакнете машината два пъти с максимално количество вода, за да отстраните напълно всички отлагания.

14 Изпразнете каната и отстранете хартиения филтър с остатъците от накипа.

15 Напълнете водния резервоар с прясна студена вода и натиснете бутона за старт, за да започнете друг процес на приготвяне.

Оставете кафемашината да завърши целия процес на приготвяне и изпразнете каната.

Забележка: При необходимост повтаряйте стъпка 14, докато водата, която излиза от кафемашината, престане да има вкус или мирис на оцет.

16 Измийте поставката за филтър и каната с гореща вода и малко течен миеш препарат.

17 Натиснете бутона за захранване, за да изключите уреда.

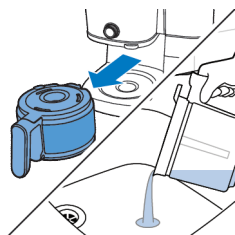

Отстраняване на неизправности

В тази глава са обобщени най-често срещаните проблеми, на които можете да се натъкнете при ползване на устройството. Ако не можете да разрешите проблема с помощта на информацията по-долу, посетете www.philips.com/support за списък с често задавани въпроси или се свържете с центъра за обслужване на потребители във вашата държава. Можете също да сканирате този QR код за повече онлайн поддръжка.



Проблем

Решение

Кафемашината не работи. Включете щепсела в стенния контакт и натиснете бутона за включване/изключване, за да включите кафемашината.

Уверете се, че посоченото върху кафемашината напрежение отговаря на това на местната електрическа мрежа.

Напълнете водния резервоар с вода.

Затворете капака на фунията на мелачката.

Мелачката не работи или не работи правилно.

Уверете се, че не сте избрали опцията за мляно кафе. Ако символът за мляно кафе се вижда на дисплея, сте избрали опцията за мляно кафе.

Почистете фунията на мелачката, като следвате инструкциите.

Когато използвам мелачката, кафето е прекалено слабо.

Завъртете копчето за вида смилане на кафето, за да изберете желаните тип смилане – от фино до едро.

Използвайте бутона за избор на сила, за да зададете силата на кафето от 1 до 3, като по-голямата цифра означава по-голяма сила.

Използвайте кафе на зърна с по-силен аромат или по-силна смес.

Когато използвам мляно кафе, кафето е прекалено слабо.

Уверете се, че количеството мляно кафе във филтъра е в съответствие с количеството вода във водния резервоар. Моля, имайте предвид, че кафемашината използва всичката вода във водния резервоар.

Използвайте смляно кафе с по-силен аромат или по-силна смес.

За да получите по-силно кафе, използвайте по-голямо количество мляно кафе или по-малко количество вода.

Филтърът прелива, когато извадя каната от кафемашината по време на приготвяне на кафе.

Ако извадите каната за повече от 20 секунди по време на приготвянето, функцията за спиране на капенето предизвиква преливане на поставката на филтъра. Също така имайте предвид, че кафето не достига пълния си вкус преди края на процеса на приготвяне. Затова ви съветваме да не изваждате каната и да изливате кафето преди края на процеса на приготвяне.

Кафемашината продължава да капе дълго след като процесът по приготвяне е приключил.

Капенето се причинява от кондензация на пара. Напълно нормално е кафемашината да капе известно време.

Не мога да изчакам за последните няколко капки.

Превключете копчето от режим на чаша към режим на кана, за да активирате функцията за спиране на капенето, и функцията ще спре капенето от поставката за филтър.

Ако капенето не спира, стоперът за функцията за спиране на капенето може да е запушен. За да почистите елемента за спиране на капенето, отворете държача на поставката за филтър и извадете поставката. Изплакнете поставката за филтър и елемента за спиране на капенето под течаща вода.

Кафето не е достатъчно горещо.

Кафето в каната се охлажда по-бързо, ако приготвяте само няколко чаши. Кафето остава горещо по-дълго, ако приготвите 10 чаши, което е пълна кана.

Премахнете накипа от кафемашината.

Изглежда сякаш кафето на зърна се използва бързо.

За приготвяне на перфектната чаша кафе кафемашината се нуждае от определено количество смляно кафе. Количеството кафе на зърна, което кафемашината използва, за да получи оптималното количество смляно кафе на чаша, е нормално.

Таймерът не работи.

Уверете се, че сте извършили всички стъпки за приготвяне на кафе с кафе на зърна или мляно кафе, преди да настроите таймера.

Код за грешка

Код за грешка	Описание	Решение	Забележка
E1	Недостиг на вода	Натиснете който и да е бутон, за да поставите уреда в режим на готовност. Допълнете водния резервоар и рестартирайте уреда.	Ако този проблем продължава, следвайте тези стъпки: Натиснете и задръжте едновременно бутон за почистване и за старт за три секунди, докато уредът автоматично започне да изпомпва вода за една минута. Повторете тази процедура 3 пъти. Свържете се с отдела за обслужване на клиенти, ако проблемът продължава.
E2	Не е наличен контейнер за кафе на зърна	Натиснете който и да е бутон, за да поставите уреда в режим на готовност. Прикрепете безопасно контейнера за зърна и рестартирайте уреда	Свържете се с отдела за обслужване на клиенти, ако проблемът продължава.
E3	Неправилно функциониране на нагревателната тръба	Изключете уреда от контакта. Включете щепсела в контакта и включете уреда отново, докато се охлади напълно.	Свържете се с отдела за обслужване на клиенти, ако проблемът продължава.
E4	Блокиране на колелото на мелачката	Изключете уреда от контакта. Включете щепсела в контакта и включете отново уреда. Следвайте стъпките в "Почистване на фунията на мелачката", за да почистите колелото на мелачката и улея на фунията за смляно кафе.	Свържете се с отдела за обслужване на клиенти, ако проблемът продължава.

E5	Запушване на улея на фунията за смляно кафе	Изключете уреда от контакта. Включете щепсела в контакта и включете отново уреда. Следвайте стъпките в "Почистване на фунията на мелачката", за да почистите улея на фунията за смляно кафе.	Свържете се с отдела за обслужване на клиенти, ако проблемът продължава.
E6/E7/E8	Грешка в програмата	Изключете уреда от контакта. Включете щепсела в контакта и включете отново уреда.	Свържете се с отдела за обслужване на клиенти, ако проблемът продължава.

Вступ

Вітаємо з придбанням виробу Philips!

Щоб уповні скористатися підтримкою, яку пропонує Philips, зареєструйте свій виріб на веб-сайті www.philips.com/welcome.

Загальний опис

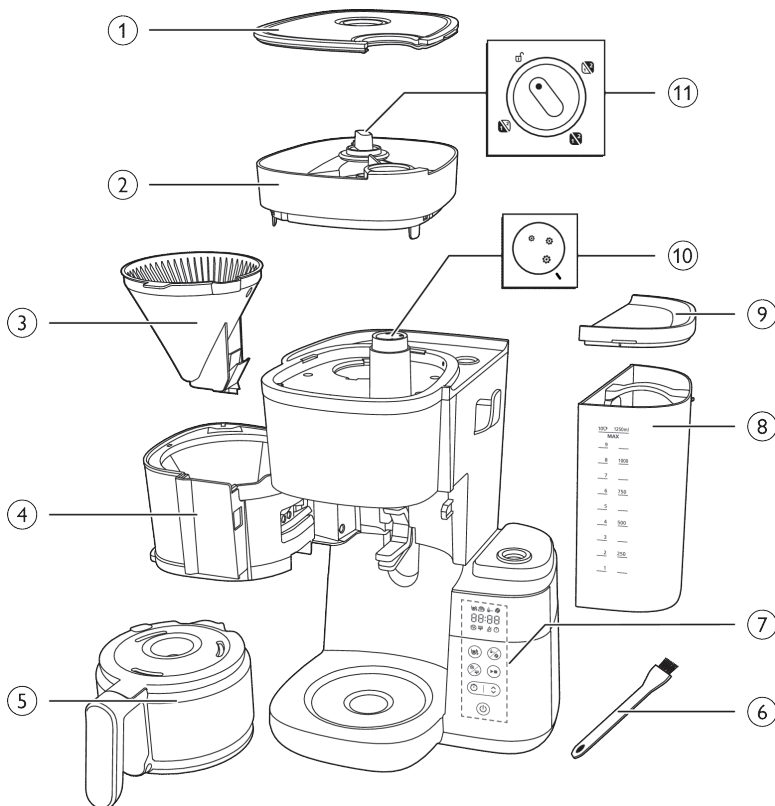

- 1 Кришка ємності для зерен
- 2 Ємність для зерен
- 3 Кошик фільтра
- 4 Тримач кошика фільтра
- 5 Скляний глек
- 6 Щітка для очищення жолоба для зерен
- 7 Панель керування з дисплеєм
- 8 Резервуар для води
- 9 Кришка резервуара для води
- 10 Регулятор грубості помелу
- 11 Регулятор вибору ємності

Панель керування



Кнопка живлення



Кнопка таймера і кнопка зі стрілкою для налаштування часу



Кнопка пуску/паузи



Кнопка очищення



Кнопка попереднього помелу та міцності кави



Кнопка вибору чашки

Піктограма на дисплеї



Кількість чашок



Режим збереження тепла



Попередньо змелена кава



Міцність кави



Видалення накипу



Сповіщення про очищення вручну



Мало води в резервуарі



Таймер



Відображення часу

Перші дві цифри позначають годину, а останні дві цифри – хвилини.



Поверніть регулятор у положення розблокування, після чого можна вийняти з пристрою ємність для зерен.



За допомогою цього регулятора можна вибрати грубість помелу, де більший розмір означає грубший помел.



Режим глека

У режимі глека працює функція запобігання протіканню.

Примітка. Процес приготування кави не зупиниться, якщо ви знімете глек. Якщо не поставити глек назад у пристрій протягом 20 секунд, кошик фільтра переповниться.



Режим чашки

Щоб запобігти витіканню води після завершення циклу приготування кави, вручну налаштуйте регулятор із режиму чашки на режим глека

Примітка. Холодне керамічне горнятко забиратиме тепло з кави, поки нагріється, тому варто попередньо розігріти чашку гарячою водою.

Важлива інформація

Попередження

- Перед тим як під'єднувати пристрій до електромережі, перевірте, чи збігається напруга, вказана на пристрої, з напругою у мережі.
- Підключайте пристрій до заземленої розетки.
- Не використовуйте пристрій, якщо штекер, шнур живлення або сам пристрій пошкоджено.
- Якщо шнур живлення пошкоджено, для уникнення небезпеки його необхідно замінити, звернувшись до сервісного центру, уповноваженого Philips, або фахівців із належною кваліфікацією.
- Цим пристроєм можуть користуватися діти віком від 8 років або більше чи особи із послабленими фізичними відчуттями або розумовими здібностями, чи без належного досвіду та знань, за умови, що користування відбувається під наглядом, їм було проведено інструктаж щодо безпечного користування пристроєм та їх було повідомлено про можливі ризики. Не дозволяйте дітям до 8 років виконувати чищення та догляд без нагляду дорослих. Зберігайте пристрій та шнур живлення подалі від дітей віком до 8 років.
- Не дозволяйте дітям бавитися пристроєм.

- Шнур живлення не повинен висіти над краєм столу або над робочою поверхнею, на якій стоїть пристрій.
- Для уникнення потенційного травмування або небезпеки використовуйте цей пристрій лише за призначенням.

Увага!

- Перед першим використанням завжди споліскуйте пристрій свіжою водою.
- Не встановлюйте пристрій на гарячу поверхню та запобігайте контакту шнура з гарячими поверхнями.
- Не ставте пристрій у шафу під час використання.
- Перед чищенням або якщо виникають проблеми, від'єднуйте пристрій від мережі.
- Завжди чистьте пристрій після повного його охолодження.
- Під час приготування кави та в режимі збереження тепла резервуар для води, тримач фільтра, плита, нижня частина пристрою, а також глек із кавою є гарячими навіть якийсь час після завершення роботи пристрою.
- Не кладіть глек на плиту або в мікрохвильовому для повторного нагрівання кави.
- Цей пристрій призначений для побутового використання вдома та в інших подібних місцях: у жилих будівлях на фермах, у готелях із комплексом послуг "ночівля і сніданок", на службових кухнях у магазинах, офісах та в інших виробничих умовах, а також клієнтами в готелях, мотелях та інших житлових середовищах.
- Перевірку та ремонт пристрою слід проводити виключно у сервісному центрі, уповноваженому Philips. Не розбирайте пристрій і не намагайтеся відремонтувати пристрій самостійно.
- Поверхня нагрівального елемента, тримач фільтра, нижня частина пристрою, плита і глек із кавою залишаються гарячими ще якийсь час після використання.
- Якщо не вказано інше, весь пакувальний матеріал у коробці виготовлено з переробленого паперу; див. маркування PAP на коробці.

Видалення накипу

- Видаляйте накип із кавомашини, коли помітите на дисплеї попередження про видалення накипу. Для видалення накипу використовуйте лише білий оцет, оскільки інші продукти можуть пошкодити пристрій.

Електромагнітні поля (ЕМП)

Цей пристрій Philips відповідає стандартам, які стосуються електромагнітних полів (ЕМП).

Переробка



Цей символ означає, що цей виріб не підлягає утилізації зі звичайними побутовими відходами (2012/19/EU).

Дотримуйтесь правил розділеного збору електричних та електронних пристроїв у вашій країні. Належна утилізація допоможе запобігти негативному впливу на навколишнє середовище та здоров'я людей.

Якщо не вказано інше, весь пакувальний матеріал у коробці виготовлено з переробленого паперу; див. маркування PAP на коробці.

Гарантія та підтримка

Versuni пропонує два роки гарантії на цей виріб після дати придбання. Ця гарантія втрачає чинність, якщо несправність виникла внаслідок неправильного використання або обслуговування пристрою. Наша гарантія не впливає на ваші законні права як споживача. Щоб отримати додаткову інформацію або скористатися гарантією, відвідайте наш вебсайт www.philips.com/support.

Перед першим використанням

Після кожного використання чистьте тримач фільтра та постійний фільтр.

Після кожного використання ретельно протирайте тримач фільтра сухою ганчіркою. Обов'язково чистьте пристрій від конденсату.

Налаштування годинника

- 1 Під'єднайте пристрій до мережі.
 - Відображення години почне блимати.

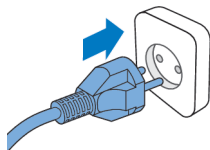

08:00



- 2 За допомогою кнопки зі стрілками налаштуйте годину.

08: 

3 Налаштувавши годину, натисніть кнопку таймера для підтвердження.

08:06



4 Почне блимати індикація хвилин. За допомогою кнопки зі стрілками налаштуйте хвилини.

08:06 

5 Натисніть кнопку таймера для підтвердження хвилин.



08:06

- Поточний час встановлено і збережено.

6 Щоб налаштувати таймер у режимі очікування, можна вибрати один із двох варіантів нижче:

- Вимкніть пристрій і знову під'єднайте його до мережі.

- Натисніть та утримуйте кнопку таймера, поки не почнуть блимати цифри години.

Примітка

Пристрій завжди зберігає останнє налаштування.

Час збереження тепла

Можна вибрати, скільки часу потрібно підтримувати каву гарячою після приготування, налаштувавши час, після якого пристрій автоматично вимкнеться. Стандартний час автоматичного вимкнення – 30 хвилин. Максимальний час автоматичного вимкнення – 300 хвилин.

Щоб налаштувати час автоматичного вимкнення, виконайте наведені нижче дії:

1 Вимкніть пристрій, але не від'єднуйте його від мережі.

2 Натисніть та утримуйте кнопку очищення, поки не з'явиться піктограма збереження тепла і не почне блимати година.

3 Виконайте крок у розділі «Налаштування годинника», щоб завершити налаштування.

Промивання пристрою

Перед першим використанням завжди промивайте кавоварку, дотримуючись наведених нижче дій.

Попередження: Ніколи не наливайте воду в ємність для зерен, оскільки це пошкодить кавоварку.

1 Відкрийте кришку резервуара для води.

Увага! Не кладіть кавові зерна або мелену каву у резервуар для води.

2 Можна наповнити резервуар водою будь-яким способом, наведеним нижче:

- Зніміть резервуар із пристрою і помістіть його під краном, щоб наповнити водою.

- Встановлюючи його на місце, переконайтеся, що гачок належним чином прикріплено.
- Візьміться за ручку кришки, щоб підняти кришку глека. Підставте глек для кави під кран, щоб наповнити його водою. Наповніть резервуар водою з глека для кави.
- Не наливайте воду вище максимального рівня.

3 Закрийте кришку резервуара для води.

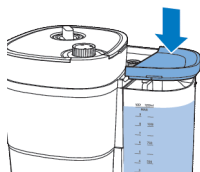
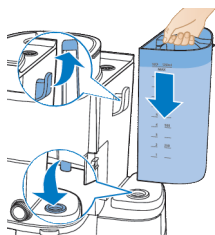
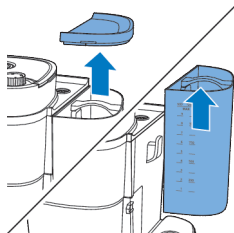

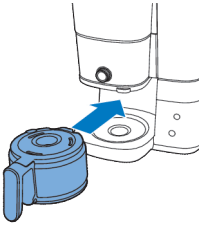

4 Поставте глек для кави у пристрій.

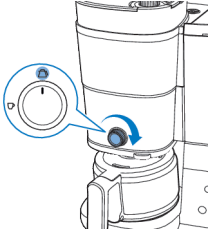

5 Поверніть центральний регулятор у положення глека.



6 Натисніть кнопку увімкнення.
- Пристрій увімкнеться.



7 Натисніть кнопку міцності кави і виберіть попередньо змелену каву.

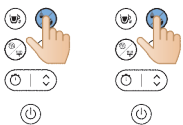

8 Натисніть кнопку чашки і виберіть 10 чашок.

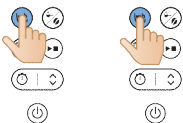



9 Натисніть кнопку пуску.

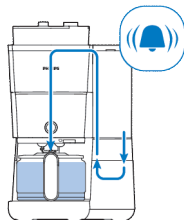

10 Пристрій почне процес промивання.

11 Дайте пристрою попрацювати, поки процес промивання не завершиться.



12 Спорожніть скляний глек.

Використання пристрою

Використання кавових зерен

Примітка. Кавомашина використовуватиме необхідну кількість води залежно від кількості чашок кави, які потрібно приготувати.

Виконайте описані нижче дії, щоб почати:

1 Відкрийте кришку резервуара для води і вийміть резервуар із пристрою.

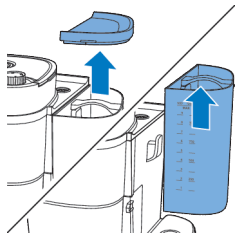

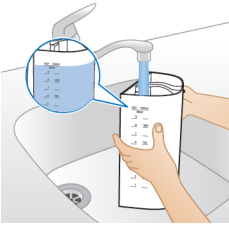

- 2 Наповніть резервуар водою з-під крана.
- Рівень води не повинен перевищувати максимальний.

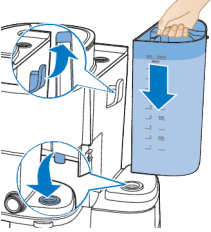

- 3 Вставте резервуар назад у пристрій.
- Гачок має бути прикріплено належним чином.

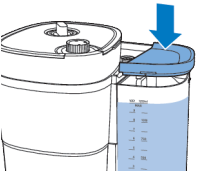

- 4 Закрийте кришку резервуара для води.

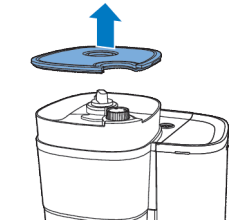

- 5 Підніміть кришку ємності для зерен.

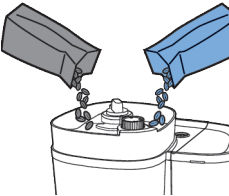

- 6 Додайте у ємність бажані кавові зерна.

Примітка. Завжди слідкуйте за тим, щоб подвійна ємність для свіжих зерен була заповнена принаймні наполовину.

Попередження: Для запобігання забиванню кавомолки не використовуйте сирі або карамелізовані зерна. Використовуйте кавові зерна замість еспресо, оскільки зерна еспресо можуть пошкодити кавомолку.

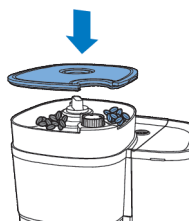

7 Закрийте кришку ємності для зерен.

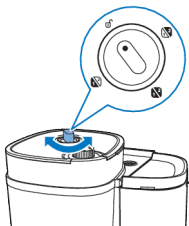

8 Поверніть регулятор вибору ємності, щоб вибрати бажані зерна з двох ємностей.

- Для унікального смаку кави можна навіть змішувати різні типи зерен.

Примітка. Щоразу, коли ви перемикатимете між контейнерами для кавових зерен або типами зерен, завжди залишатимуться сліди меленої кави попереднього типу зерен. Щоб запобігти цьому, перейшовши на новий тип кавових зерен, почистьте лійку кавомолки.

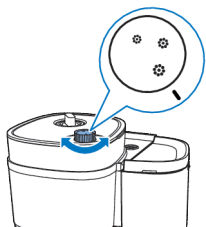

9 За допомогою регулятора виберіть потрібний рівень грубості помелу.

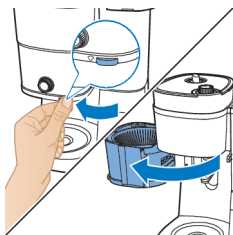

10 Візьміться за ручку, щоб відкрити тримач фільтра.

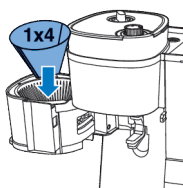

11 Вставте паперовий фільтр (типу 1x4 або №4) у кошик фільтра.

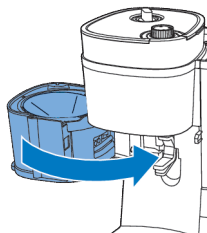

12 Закрийте тримач фільтра.

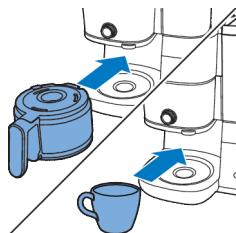

13 Поставте глек для кави або чашку під диспенсер.

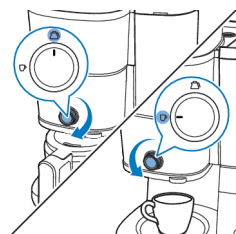

14 За допомогою регулятора виберіть кількість кави, яку потрібно приготувати.

Використовуючи функцію приготування в чашку, можна брати скляні або керамічні горнятка, а також склянки. Використовуйте чашки висотою менше 10 см.

WS 3



15 Увімкніть пристрій.

WS 3



16 Виберіть кількість чашок, які потрібно приготувати, натиснувши кнопку чашки.



17 Натисніть кнопку міцності, щоб вибрати потрібну міцність кави.

- 1: зерно для кави з м'яким смаком
- 2: зерна для кави середньої міцності
- 3: зерна для міцної кави



18 Почніть процес, натиснувши кнопку пуску/паузи.



19 Пристрій починає роботу.

- Пристрій подасть звуковий сигнал після завершення.

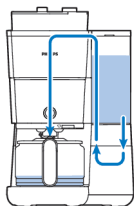

20 Заберіть чашку або глек для кави з пристрою.

Функція запобігання протіканню дозволяє зняти глек із кавоварки перед тим, як процес приготування буде завершено. Коли ви заберете глек, система запобігання протіканню зупинить потік кави у глек.

Процес приготування кави не зупиниться, якщо ви знімете глек. Якщо не поставити глек назад у пристрій протягом 20 секунд, кошик фільтра переповниться.

21 Насолоджуйтеся свіжозвареною кавою.

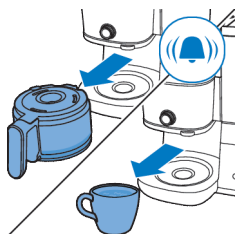



22 Щоб вимкнути пристрій, натисніть та утримуйте кнопку пуску/паузи протягом трьох секунд.

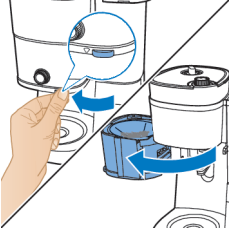

23 Відкрийте тримач фільтра

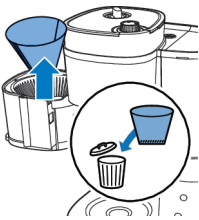

24 Вийміть використаний паперовий фільтр.

Функція збереження тепла не активується під час приготування однієї або двох 2 чашок кави.

Пристрій підтримуватиме тепло напою, поки не вимкнеться автоматично. Щоб вимкнути збереження тепла напою, натисніть кнопку увімк./вимк., щоб вимкнути пристрій.

Використання попередньо змеленої кави

Виконайте описані нижче дії, щоб почати:

1 Перевірте, чи в пристрої достатньо води для приготування потрібної кількості кави.

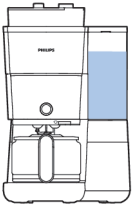

2 Візьміться за ручку, щоб відкрити тримач фільтра.

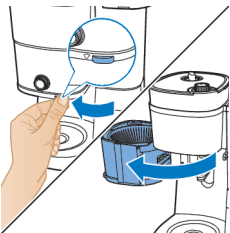

3 Вставте паперовий фільтр (типу 1x4 або №4) у кошик фільтра.

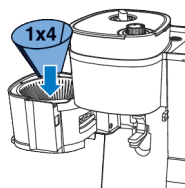

4 Додайте потрібну кількість попередньо змеленої кави у паперовий фільтр залежно від власних уподобань.
- Для стандартної чашки кави використовуйте 6 г або 1 столову ложку меленої кави.

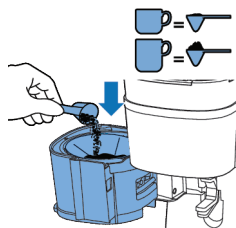

5 Закрийте тримач фільтра.

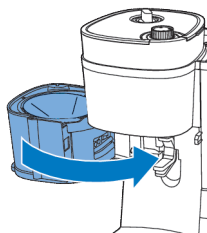

6 Поставте глек для кави або чашку під диспенсер.

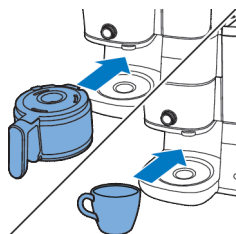

7 За допомогою регулятора виберіть кількість кави, яку потрібно приготувати.

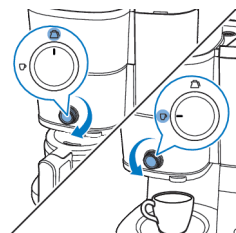



8 Увімкніть пристрій.



9 Виберіть використання попередньо змеленої кави, натиснувши кнопку вибору режиму.

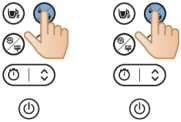

10 Виберіть кількість чашок, які потрібно приготувати, натиснувши кнопку чашки.

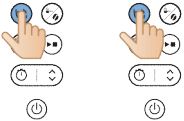

11 Почніть процес, натиснувши кнопку пуску/паузи.



12 Пристрій починає роботу.

- Пристрій подасть звуковий сигнал після завершення.

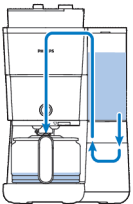

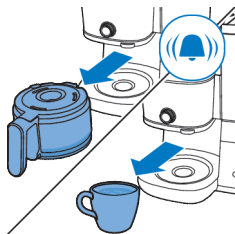

13 Заберіть чашку або глек для кави з пристрою.



14 Насолоджуйтеся свіжозвареною кавою.



15 Щоб вимкнути пристрій, натисніть та утримуйте кнопку пуску/паузи протягом трьох секунд.

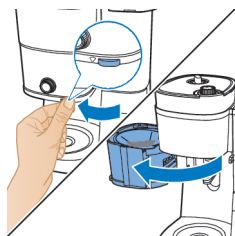

16 Відкрийте тримач фільтра

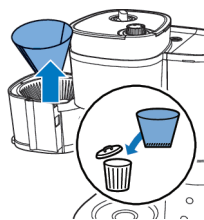

17 Вийміть використаний паперовий фільтр.

Налаштування таймера

Щоб налаштувати таймер на пристрої виконайте такі дії:

- 1 Увімкніть кавомашину.
- 2 Натисніть кнопку таймера, і на дисплеї з'явиться піктограма таймера. Блимають цифри години, позначаючи налаштування години.



- 3 За допомогою кнопки зі стрілками налаштуйте годину. Якщо потрібно швидко налаштувати, утримуйте кнопку зі стрілками натисненою.



- 4 Натисніть кнопку таймера, щоб підтвердити встановлену годину. Цифри хвилин позначають налаштування хвилин.



- 5 Щоб налаштувати хвилини, знову скористайтеся кнопкою зі стрілками. Якщо потрібно швидко налаштувати, утримуйте кнопку зі стрілками натисненою.

08:05



- 6 Натисніть кнопку таймера ще раз, щоб підтвердити встановлені хвилини.

Щоб скасувати налаштування таймера, просто натисніть кнопку таймера, і піктограма таймера зникне з дисплея.

Функція запобігання протіканню дозволяє зняти глек із кавоварки перед тим, як процес приготування буде завершено. Коли ви заберете глек, система запобігання протіканню зупинить потік кави у глек.

Примітка. Процес приготування кави не зупиниться, якщо ви знімете глек. Якщо не поставити глек назад у пристрій протягом 20 секунд, кошик фільтра переповниться.

Чищення та догляд

Чищення після кожного використання

У жодному разі не занурюйте кавомашину у воду чи іншу рідину та не мийте її під краном.

- 1 Витягніть штепсель із розетки.

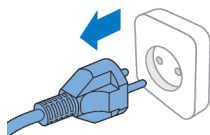









- 2 Протріть кавомашину зовні вологою ганчіркою.
3 Помийте кошик фільтра гарячою водою з миючим засобом або в посудомийній машині.



- 4 Помийте глек для кави та кришку під краном. Або помийте їх у посудомийній машині.

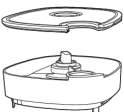

			
	✓	✓	✓
	✓	✓	✓
	✓	✓	✓
	✓	✗	✓
	✓	✗	✓

Чищення лійки кавомолки

Важлива інформація!

Для запобігання забиванню меленою кавою чистьте лійку кавомолки кожні 1–2 тижні. Це можна легко і швидко зробити за допомогою наведених нижче кроків.

Чистьте лійку кавомолки, коли помітите на дисплеї попередження зі щіткою.

Примітка. Перш ніж почати процедуру очищення, перевірте, чи ємність для кавових зерен порожня.

1 Під'єднайте пристрій до мережі.

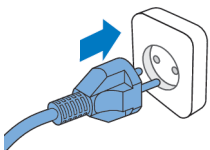

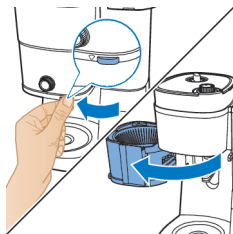

2 Відкрийте тримач фільтра, щоб отримати доступ до жолоба лійки.

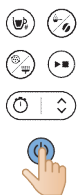

3 Увімкніть кавомашину.

4 Натисніть кнопку очищення на панелі керування кавомашини.

5 Виберіть налаштування щітки на екрані дисплея.



6 Натисніть кнопку пуску. Це призведе до того, що заслінка жолоба лійки відкриється, а ви зможете почистити жолоб щіткою.

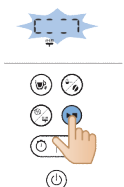

7 За допомогою щітки видаліть мелену каву та будь-які залишки, які могли накопичуватися в жолобі.

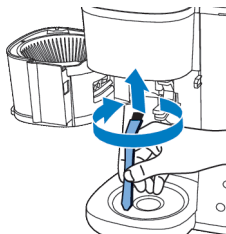

- 8 Почистивши жолоб, натисніть кнопку пуску ще раз, щоб закрити заслінку.



Видалення накипу з кавомашини

Видаляйте накип із кавомашини, коли помітите на дисплеї попередження про видалення накипу. Для видалення накипу використовуйте лише білий оцет, оскільки інші продукти можуть пошкодити кавомашину.

Попередження: Для видалення накипу ніколи не використовуйте оцет із вмістом оцтової кислоти 8% або більше, натуральний оцет або засоби для видалення накипу у вигляді порошку або таблеток, оскільки це може пошкодити пристрій.

- 1 Відкрийте кришку резервуара для води.

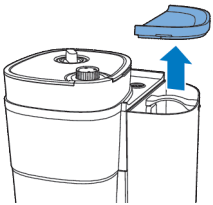

- 2 Налийте в резервуар для води білий оцет (4% розчин оцтової кислоти) до позначки 10 чашок.

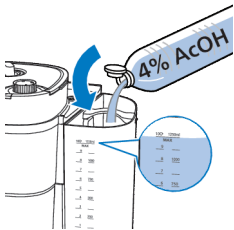

3 Закрийте кришку резервуара для води.

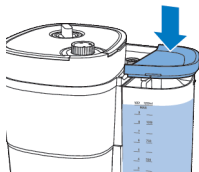

4 Візьміться за ручку, щоб відкрити тримач фільтра.

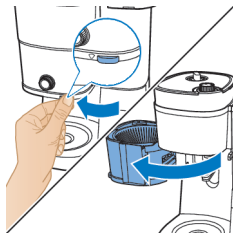

5 Встановіть паперовий фільтр (типу 1x4 або № 4) у кошик фільтра та закрийте тримач кошика фільтра.

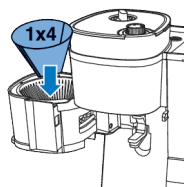

6 Поставте порожній глек у кавомашину.

7 Вставте штекер у розетку.

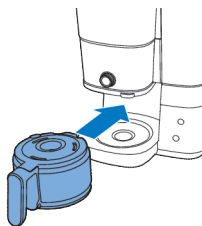

8 Натисніть кнопку живлення, щоб увімкнути кавомашину. Засвітиться дисплей.

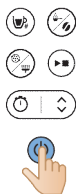

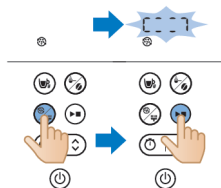

- 9 Натисніть кнопку очищення на кавомашині.
 - 10 Виберіть налаштування видалення накипу.
 - 11 Для підтвердження вибору натисніть кнопку пуску.
- Кавомашина автоматично почне процес видалення накипу.

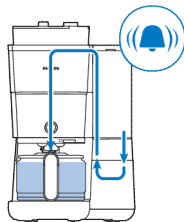

- 12 Зачекайте, поки пристрій завершить роботу з розчину для видалення накипу.
- 13 Після завершення процесу видалення накипу двічі сполосніть пристрій із максимальною кількістю води, щоб повністю видалити будь-які відкладення.

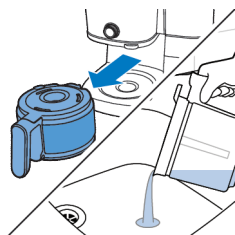

- 14 Спорожніть глек і вийміть паперовий фільтр із залишками накипу.
- 15 Наповніть резервуар свіжою холодною водою і натисніть кнопку пуску, щоб розпочати ще один процес приготування кави. Дайте кавомашині завершити весь процес приготування кави і спорожніть глек.

Примітка. У разі потреби повторюйте крок 14, поки вода, яка витікає з кавомашини, не позбудеться присмаку чи запаху оцту.

- 16 Помийте кошик фільтра і глек гарячою водою з миючим засобом.
- 17 Натисніть кнопку живлення, щоб вимкнути пристрій.

Усунення несправностей

У цьому розділі подано основні проблеми, які можуть виникнути під час використання пристрою. Якщо ви не в змозі вирішити проблему за допомогою інформації, поданої нижче, відвідайте вебсайт www.philips.com/support для перегляду списку поширених запитань або зверніться до Центру обслуговування клієнтів у своїй країні. Ви також можете відсканувати цей QR-код для отримання додаткової онлайн-підтримки.



Проблема

Кавомашина не працює.

Вирішення

Вставте штекер у розетку і натисніть кнопку увімк./вимк., щоб увімкнути кавомашину.

Перевірте, чи збігається напруга, вказана на кавомашині, з напругою в локальній мережі.

Наповніть резервуар водою.

Закрийте кришку лійки кавомолки.

Кавомолка не працює взагалі або не працює належним чином.

Переконайтеся, що ви не вибрали попередньо змелену каву. Якщо на дисплеї з'являється символ попередньо змеленої кави, вибрано попередньо змелену каву.

Почистьте лійку кавомолки, дотримуючись інструкцій.

У разі використання кавомолки кави надто слабка.

Поверніть регулятор грубості помелу для вибору бажаного типу помелу від дрібного до грубого.

За допомогою кнопки вибору міцності кави встановіть міцність від 1 до 3; де більша цифра означає більшу міцність.

Беріть кавові зерна міцнішої суміші або смаку.

У разі використання попередньо змеленої кави, кави надто слабка.

Кількість попередньо змеленої кави у фільтрі має відповідати кількості води у резервуарі. Пам'ятайте, що кавомашина використовує всю воду у резервуарі.

Беріть змелену каву міцнішої суміші або смаку.

Щоб приготувати міцнішу каву, збільште кількість попередньо змеленої кави або зменште кількість води.

Фільтр протікає, коли глек знято з кавомашини, поки кави ще готується.

Якщо під час приготування кави глек зняти довше, ніж на 20 секунд, система запобігання протіканню спричиняє переливання з кошика фільтра. Також зауважте, що кави не досягає повного смаку до закінчення процесу приготування. Тому радимо не забирати глек і не вливати каву до завершення процесу приготування.

Із кавомашини продовжує витікати рідина ще довгий час після приготування кави.

Витікання відбувається внаслідок конденсації пари. Це цілком нормально, коли з кавоварки крапає деякий час.

Неможливо дочекатися останніх крапель.

Перемкніть регулятор із режиму чашки на режим глека, щоб відкрити функцію запобігання протіканню, система запобігання протіканню зупинить крапання з кошика фільтра.

Якщо крапання не припиниться, можливо, систему запобігання протіканню заблоковано. Щоб почистити систему запобігання протіканню, відкрийте тримач кошика фільтра і вийміть кошик фільтра. Сполосніть кошик фільтра та систему запобігання протіканню під краном.

Кави недостатньо гаряча.

Кави у глеку швидше охолоджується, якщо приготувати лише кілька чашок. Кави довше залишається гарячою, якщо приготувати 10 чашок (повний глек).

Видаліть накип із кавомашини.

Здається, що кавові зерна швидко використовуються.

Для приготування ідеальної чашки кави кавомашина потребує певної кількості меленої кави. Кількість кавових зерен, яку кавоварка використовує для отримання оптимальної кількості меленої кави на чашку, є нормальною.

Таймер не працює.

Переконайтеся, що ви виконали всі кроки для приготування кави з зерен або меленої кави перед тим, як встановити таймер.

Код помилки

Код помилки	Опис	Вирішення	Примітка
E1	Недостатньо води	Натисніть будь-яку кнопку, щоб перевести пристрій у режим очікування. Наповніть резервуар водою та перезапустіть пристрій.	Якщо проблема не зникне, виконайте наведені нижче дії: Натисніть та утримуйте одночасно кнопку очищення й пуску протягом трьох секунд, поки пристрій не почне автоматично відкачувати воду протягом однієї хвилини. Повторіть цей процес 3 рази. Якщо проблема далі не зникне, зверніться до служби обслуговування клієнтів.
E2	Немає ємності для зерен	Натисніть будь-яку кнопку, щоб перевести пристрій у режим очікування. Надійно встановіть ємність для зерен і перезапустіть пристрій.	Якщо проблема не зникне, зверніться до служби обслуговування клієнтів.
E3	Несправність нагрівальної трубки	Від'єднайте пристрій від мережі. Знову під'єднайте пристрій до мережі та увімкніть, поки він повністю не охолоне.	Якщо проблема не зникне, зверніться до служби обслуговування клієнтів.
E4	Блокування диска кавомолки	Від'єднайте пристрій від мережі. Знову під'єднайте пристрій до мережі та увімкніть. Виконайте кроки у розділі «Чищення лійки кавомолки», щоб почистити диск кавомолки і жолоб лійки.	Якщо проблема не зникне, зверніться до служби обслуговування клієнтів.
E5	Блокування жолоба лійки	Від'єднайте пристрій від мережі. Знову під'єднайте пристрій до мережі та увімкніть. Виконайте кроки у розділі «Чищення лійки кавомолки», щоб почистити жолоб лійки.	Якщо проблема не зникне, зверніться до служби обслуговування клієнтів.
E6/E7/ E8	Програмна помилка	Від'єднайте пристрій від мережі. Знову під'єднайте пристрій до мережі та увімкніть.	Якщо проблема не зникне, зверніться до служби обслуговування клієнтів.

מבוא

ברכותינו על רכישתך וברוך בואך למשפחת מוצרי פיליפס!
 כדי להפיק את מלוא התועלת מהתמיכה שפיליפס מעניקה ללקוחותיה, רשמו את המוצר
 בכתובת www.philips.com/welcome.

תיאור כללי

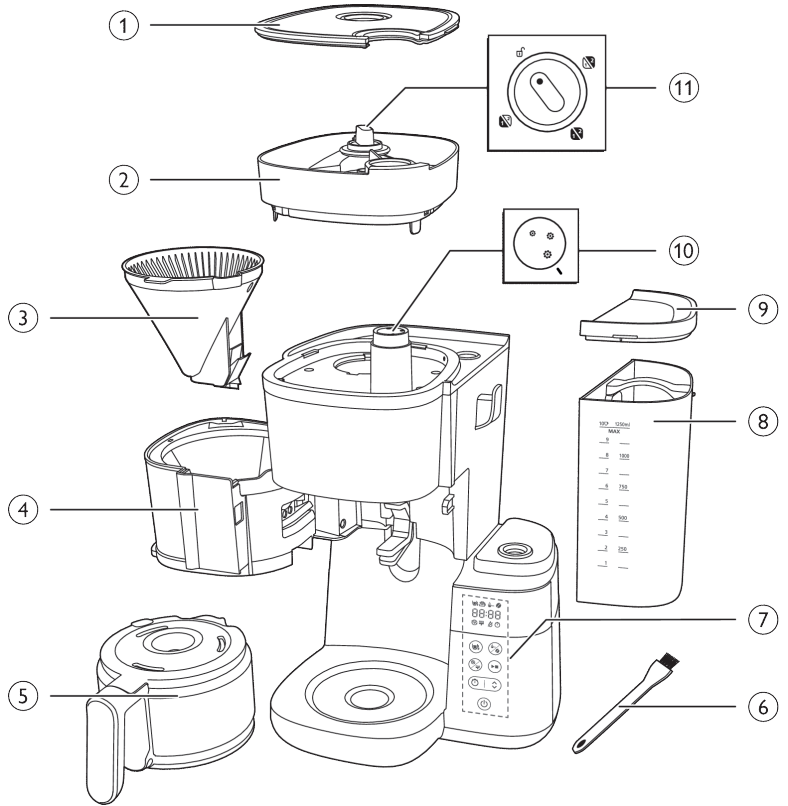

- 1 מכסה מכל פולי קפה
- 2 מכל פולי קפה
- 3 סלסלת הפילטר
- 4 תושבת סלסלת הפילטר
- 5 קנגקון זכוכית
- 6 מברשת ניקוי לפתח יציאת הפולים
- 7 לוח בקרה עם תצוגה
- 8 מכל המים
- 9 מכסה מכל המים
- 10 ידית מידת טחינה
- 11 ידית בורר מכל

לוח בקרה

לחצן הפעלה/כיבוי



לחצן טיימר ולחצן חיצים לכיוון השעון



לחצן הפעלה/השהייה



לחצן ניקוי



לחצן קפה טחון מראש וחוזק הקפה



לחצן בחירת כוס



סמל תצוגה

מספר כוסות



מצב שמירת חום



קפה טחון מראש



חוזק הקפה



הסרת אבנית



התראה לניקוי ידני



כמות מים נמוכה



טיימר



00:00

תצוגת זמן
שתי הספרות הראשונות מייצגות את השעות ושתי הספרות
האחרונות מייצגות את הדקות.

יש לסובב את הידית כדי לשחרר את הנעילה, ואז ניתן
להסיר את מכל פולי הקפה מהמכשיר.



לחצן זה בוחר את מידת טחינת הקפה, כאשר גודל גדול
יותר מציין טחינה גסה יותר.



מצב קנקן

במצב קנקן זכוכית קיימת פונקציית הפסקת טפטוף.
הערה: הסרת קנקן הזכוכית אינה מפסיקה את תהליך
הכנת הקפה. אם הקנקן לא יוחזר למכשיר תוך 20 דקות,
סלסלת הפילטר תעלה על גדותיה.



מצב כוס

יש לסובב ידנית את הידית ממצב קנקן למצב כוס כדי לפתוח
את פונקציית 'הפסקת טפטוף' ולמנוע טפטופים כשמחזור
הכנת הקפה מסתיים
הערה: כוס קרמית קרה "תגנוב" חום מהקפה בזמן שהוא
מתחמם, לכן מומלץ לחמם מראש את הכוס במים חמים.



חשוב

אזהרה

- לפני חיבור המכשיר, יש לוודא שהמתח המצוין על המכשיר מתאים למתח החשמל המקומי.
- יש לחבר את המכשיר לשקע חשמל בקיר המצויד בהארקה.
- אין להשתמש במכשיר אם השקע, כבל החשמל או המכשיר עצמו פגומים.
- כדי למנוע סכנה מכבל חשמל פגום, יש לוודא שיוחלף בידי פיליפס, מרכז שירות מורשה של פיליפס או נותני שירות מורשים אחרים.
- ילדים בני 8 ומעלה ומבוגרים בעלי יכולות פיזיות, תחושתיות או שכליות מוגבלות, או על ידי מבוגרים חסרי ניסיון וידע, יכולים להשתמש במכשיר זה רק אם השימוש נעשה תחת השגחה או לאחר שקיבלו הדרכה על אופן השימוש הבטוח בו והם מבינים את הסיכונים הכרוכים. אין לאפשר לילדים לבצע פעולות ניקוי ותחזוקה אלא אם בני שמונה שנים ובהשגחת מבוגר. יש להחזיק את המכשיר ואת כבל החשמל שלו הרחק מהישג ידם של ילדים בני פחות משמונה שנים.
- אסור לילדים לשחק עם המכשיר.
- אין לאפשר לכבל החשמל להשתלשל מטה מקצה השולחן או משטח העבודה שעליהם נמצא המכשיר.
- יש להשתמש במכשיר אך ורק למטרה לשמה הוא מיועד כדי למנוע כל אפשרות לסכנה או לפציעה.

זהירות

- יש לשטוף תמיד את המכשיר במים טריים לפני השימוש הראשון.
- אין להניח את המכשיר על משטח חם, ואסור שכבל החשמל יבוא במגע עם משטחים חמים.

- אין להניח את המכשיר בארון בעת השימוש.
- יש לנתק את המכשיר לפני ניקוי ובמקרה שמתרחשות בעיות במהלך הכנת הקפה.
- חשוב לנקות תמיד את המכשיר לאחר שמתקרר.
- מכל המים, תושבת הפילטר, צלחת החימום, החלק התחתון של המכשיר, והקנקן המלא בקפה יישארו חמים זמן נוסף גם לאחר שפעולות ההכנה והשמירה על החום הסתיימו.
- אין לשים את הקנקן על כיריים או במיקרוגל כדי לחמם מחדש את הקפה.
- מכשיר זה מיועד לשימוש ביתי או לשימוש דומה, כגון משקים חקלאיים, חדרי אירוח, מטבחונים בחנויות, משרדים וסביבות עבודה אחרות, וכן לשימוש בידי לקוחות במלונות, מלונות וסביבות מגורים אחרות.
- לצורך בדיקה או תיקון יש תמיד להחזיר את המכשיר למרכז שירות המורשה על ידי פיליפס. אסור לפתוח את המכשיר או לנסות לתקן אותו בעצמך.
- משטח גוף החימום, תושבת הפילטר, החלק התחתון של המכשיר, הצלחת החמה והקנקן המלא בקפה נתונים לחום שיורי שנמשך זמן מה לאחר השימוש.
- אלא אם צוין אחרת, כל חומרי האריזה שבקופסה עשויים מנייר ממוחזר; למידע נוסף יש לעיין בסימון ה-PAP שעל הקופסה.

הסרת אבנית

- יש לבצע הסרת אבנית בכל פעם שמופיעה התראת הסרת אבנית על גבי התצוגה. בהסרת אבנית יש להשתמש בחומץ לבן בלבד, כיוון שחומרים אחרים עלולים לגרום נזק למכשיר.

שדות אלקטרומגנטיים (EMF)

מכשיר זה של פיליפס עומד בתקנים המתייחסים לשדות אלקטרומגנטיים (EMF).

מחזור



סמל זה משמעותו שאין להשליך מוצר זה עם האשפה הביתית (EU/2012/19). יש לפעול לפי הכללים הנהוגים במדינתך לגבי איסוף נפרד של מוצרי חשמל ואלקטרוניקה המיועדים לסילוק. סילוק נכון מסייע במניעת פגיעה באיכות הסביבה ובבריאותם של בני אדם.

אלא אם צוין אחרת, כל חומרי האריזה שבקופסה עשויים מנייר ממוחזר; למידע נוסף יש לעיין בסימון ה-PAP שעל הקופסה.

אחריות ותמיכה

Versuni מציעה אחריות לשנתיים לאחר רכישת המוצר. אחריות זו אינה תקפה אם הפגם נובע משימוש לא נכון או מתחזוקה לקויה. האחריות שלנו אינה משפיעה על זכויותיך על פי חוק כצרכן. לקבלת מידע נוסף או להפעלת האחריות, בקר באתר האינטרנט שלנו www.philips.com/support.

לפני השימוש הראשון

חשוב להקפיד ולנקות את תושבת הפילטר ואת הפילטר הקבוע לאחר כל שימוש.

לאחר כל שימוש, יש לנגב את תושבת הפילטר ביסודיות עם מטלית יבשה. יש להקפיד ולנקות אותה מכל הצטברות אדים.

כיוון השעון

- 1 כעת אפשר לחבר את המכשיר לחשמל.
- תצוגת השעה תתחיל להבהב.

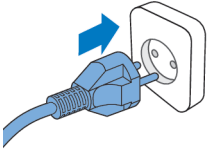

08:00



- 2 יש להשתמש בלחצן החיצים כדי לכוון את השעה.

08:00 (🔔)



- 3 לאחר הגדרת השעה, לחיצה על לחצן הטיימר תאשר את השעה.

08:06



- 4 סימון הדקות יתחיל להבהב. יש להשתמש בלחצן החיצים כדי לכוון את הדקות.

08:06 (🔔)



- 5 יש ללחוץ על לחצן הטיימר כדי לאשר ולהמשיך.



08:06

- השעה הנוכחית כעת הוגדרה ונשמרה.
- 6** כדי לכוון את שעון העצר במצב המתנה, באפשרותך לבחור בין שתי הגישות הבאות:
 - לנתק את המכשיר ולחבר אותו שוב.
 - ללחוץ לחיצה ארוכה על לחצן הטיימר עד שספרות השעה יתחילו להבהב.

הערה

המכשיר שומר תמיד את ההגדרה האחרונה.

זמן "שמירת חום"

באפשרותך לבחור כמה זמן הקפה יישאר חם לאחר ההכנה, באמצעות התאמת הזמן שלאחריו המכשיר יבצע כיבוי אוטומטי. זמן הכיבוי האוטומטי המוגדר כברירת המחדל הוא 30 דקות. זמן הכיבוי האוטומטי המרבי הוא 300 דקות.

כדי לכוון את זמן הכיבוי האוטומטי, יש לבצע את הפעולות הבאות:

- 1** לכבות את המכשיר ולהשאירו מחובר לחשמל.
- 2** ללחוץ לחיצה ארוכה על לחצן הניקוי עד שמוצג סמל "שמירת חום" והשעה מתחילה להבהב.
- 3** לעקוב אחר השלבים המופיעים ב"כיוון השעון" כדי להשלים את ההגדרה.

שטיפת המכשיר

יש לשטוף תמיד את מכונת הקפה במים טריים לפני השימוש הראשון, על פי השלבים הבאים.

אזהרה: אין לשפוך מים לתוך מיכל פולי הקפה, כיוון שזה פוגע במכונת הקפה.

- 1** יש לפתוח את מכסה מכל המים.

זהירות: אין לשים פולי קפה או קפה טחון מראש במכל המים

- 2** ניתן למלא את מכל המים בכל אחת מהדרכים הבאות:

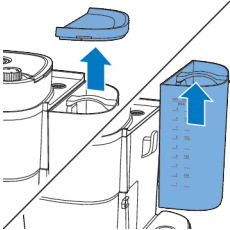

- יש להרים את המכל מחוץ למכשיר ולהניח אותו מתחת לברז כדי למלא מים.

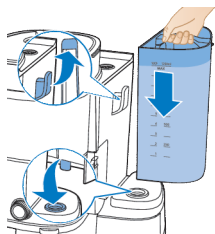

- יש לוודא שהווי מחובר היטב בעת הנחתו חזרה במקומו.
- יש לאחוז בלשונית שחרור המכסה כדי למשוך את מכסה הקנקן. יש להניח את קנקן הקפה מתחת לברז ולמלא בו מים. יש למלא את מיכל המים באמצעות קנקן הקפה.
- חשוב לוודא שהמים לא עוברים את הגובה המקסימלי.

3 יש לסגור את מכסה מכל המים.

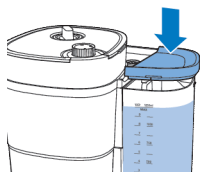

4 יש להחזיר את קנקן הקפה אל המכשיר.

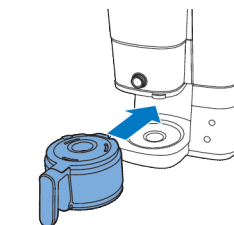

5 יש לסובב את הידית המרכזית למצב קנקן.

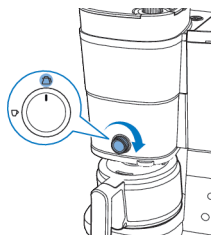

6 יש ללחוץ על לחצן הפעלה/כיבוי המכשיר מופעל.



7 יש ללחוץ על לחצן חוזק הקפה ולבחור בקפה טחון מראש.



8 יש ללחוץ על לחצן הכוס ולהגדיר 10 כוסות.

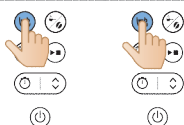

9 יש ללחוץ על לחצן ההפעלה.



10 המכשיר מתחיל את תהליך השטיפה.
11 יש להניח למכשיר לפעול עד לסיום תהליך הסמקה.

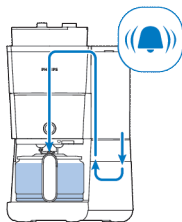

12 יש לרוקן את קנקן הזכוכית.



שימוש במכשיר

שימוש בפולי קפה

הערה: מכונת הקפה תשתמש בכמות המים הנדרשת בהתבסס על מספר הכוסות שנדרשה להכין

לשימוש יש לעקוב אחר ההוראות הבאות:

1 יש לפתוח את המכסה של מכל המים ולהרים את המיכל מתוך המכשיר.

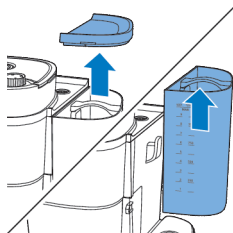

2 יש למלא את המכל במי ברז. חשוב לוודא שכמות המים אינה עולה על הרמה המרבית.



3 יש להניח את המכל בחזרה על המכשיר. יש לוודא שהמכשיר מחובר כראוי.

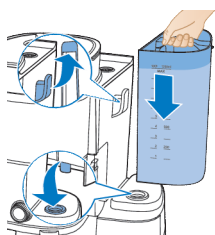

4 יש לסגור את המכסה של מכל המים.

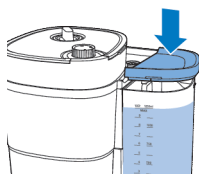

5 יש להרים את המכסה של מכל פולי הקפה.

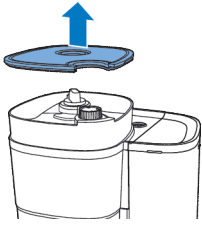

6 יש להוסיף את פולי הקפה הרצויים למכל.

הערה: יש לוודא תמיד שמיקל הקפה הכפול מלא בפולים טריים לפחות עד חצי מהנפח.

אזהרה: כדי למנוע תקלות וחסומות במטחנה, אין להשתמש בפולי קפה לא קלויים או מקורמלים. פולי אספרסו עלולים לגרום נזק למטחנה, לכן יש להשתמש בפולי קפה ולא בפולי אספרסו.

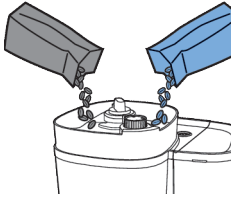

7 יש לסגור את המכסה של מכל פולי הקפה.

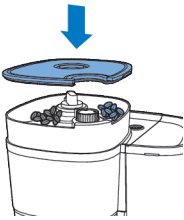

8 סובב את ידית בורר המכל כדי לבחור את הפולים הרצויים מבין שני המכלים. אפשר אפילו לערבב שני סוגי פולים שונים ליצירת תערובת ייחודית.

הערה: בכל מעבר בין מכלי פולי קפה או בהחלפת פולים, תמיד יישארו עקבות קפה מהסוג הקודם שנטחן. יש לנקות את משפך המטחנה לאחר החלפה לסוג חדש של פולים כדי למנוע זאת.

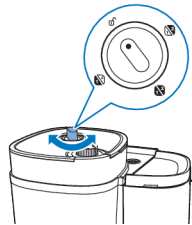

9 יש לבחור את מידת הטחינה הרצויה על-ידי סיבוב הידית.

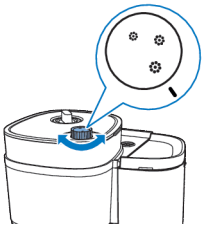

10 יש לאחוז בלשונית כדי לפתוח את תושבת הפילטר.

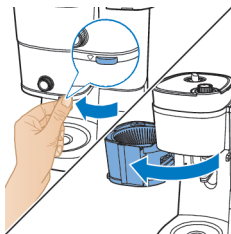

11 יש להניח פילטר נייר (סוג 1x4 או מספר 4) בתוך סלסלת הפילטר.

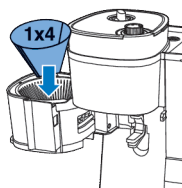

12 יש לסגור את תושבת הפילטר

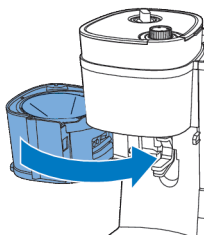

13 יש להניח את קנקן הקפה או את הספל מתחת למתקן.

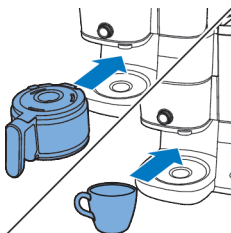

14 יש לסובב את הידיית כדי לבחור את כמות הקפה שברצונך להכין.

בשימוש באפשרות הכנת קפה בתוך כוס, ניתן להשתמש בספלים ובכוסות, מזכוכית או מחרס. חשוב להקפיד להשתמש בכוסות שגובהן נמוך מ-10 ס"מ.

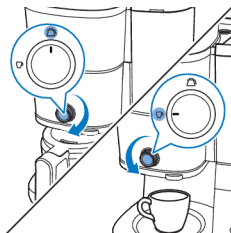

15 יש להפעיל את המכשיר.

10 3



16 יש לבחור את מספר הכוסות הרצוי בלחיצה על לחצן הכוס.

3



17 לחץ על לחצן חוזק הקפה כדי לבחור את החוזק המועדף עליך.

- 1: פולים לקפה חלש

- 2: פולים לקפה בינוני-חזק

- 3: פולים לקפה חזק

2



18 לחיצה על לחצן הפעלה/השהייה תתחיל את התהליך.



19 המכשיר מתחיל בעבודה.

- המכשיר יצפצף בסיום.

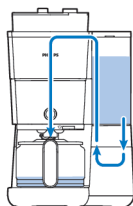

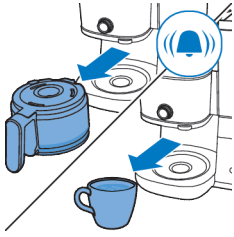

20 יש להוציא את הכוס או את קנקן הקפה מהמכשיר.

פונקציית הפסקת הטפטוף מאפשרת לך להסיר את הקנקן ממכונת הקפה לפני שתהליך ההכנה מסתיים. עם הסרת הקנקן, פונקציית הפסקת הטפטוף עוצרת את זרימת הקפה לתוך הקנקן.

הסרת קנקן הזכוכית אינה מפסיקה את תהליך הכנת הקפה. אם הקנקן לא יוחזר למכשיר תוך 20 דקות, סלסלת הפילטר תעלה על גדותיה.

21 תיהנו מהקפה הטרי שלכם.



22 כדי לכבות את המכשיר, יש ללחוץ לחיצה ארוכה על לחצן הפעלה/השהייה למשך שלוש שניות.

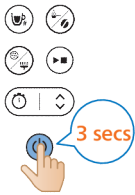

23 יש לפתוח את תושבת הפילטר.

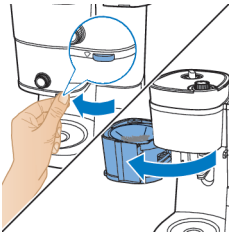

24 יש להסיר את פילטר הנייר המשומש.

פונקציית "שמירת חום" אינה מופעלת בהכנת כוס אחת או שתיים.

המכשיר ישמור על המשקה חם עד שיכבה אוטומטית. אם אין ברצונך להשאיר את המשקה בחימום, יש ללחוץ על לחצן הפעלה/כיבוי כדי לכבות את המכשיר.

שימוש בקפה טחון

לשימוש יש לעקוב אחר ההוראות הבאות:

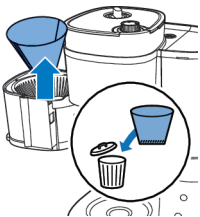

1 יש לוודא כי המכשיר מכיל מספיק מים להכנת כמות הקפה הרצויה.



2 יש לאחוז בלשונית כדי לפתוח את תושבת הפילטר.

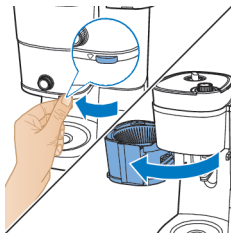

3 יש להניח פילטר נייר (סוג 1x4 או מספר 4) בתוך סלסלת הפילטר.

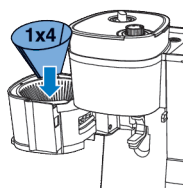

4 יש להוסיף את כמות הקפה הטחון בפילטר הנייר שבחרת בהתאם להעדפתך האישית.

- עבור כוס קפה סטנדרטית, יש להשתמש ב-6 גרם של קפה טחון, או כף אחת.

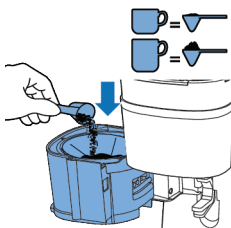

5 יש לסגור את תושבת הפילטר.

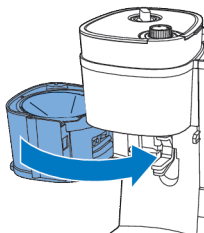

6 יש להניח את קנקן הקפה או את הספל מתחת למתקן.

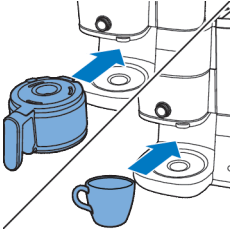

7 יש לסובב את הידית כדי לבחור את כמות הקפה שברצונך להכין.

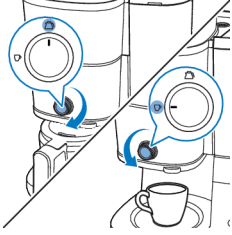

8 יש להפעיל את המכשיר.

10 3



9 יש ללחוץ על לחצן בחירת המצב כדי לבחור בשימוש בקפה טחון מראש.

10 3 → 10 4

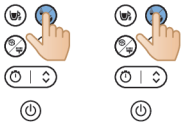

10 יש לבחור את מספר הכוסות הרצוי בלחיצה על לחצן הכוס.

10 3 → 10 4

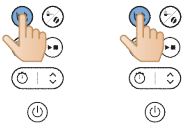

11 לחיצה על לחצן הפעלה/השהייה תתחיל את התהליך.

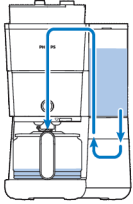

12 המכשיר מתחיל בעבודה.
- המכשיר יצפצף בסיום.

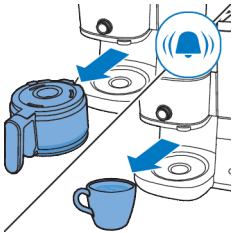

13 יש להוציא את הכוס או את קנקן הקפה מהמכשיר.



14 תיהנו מהקפה הטרי שלכם.

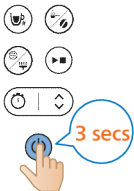

15 כדי לכבות את המכשיר, יש ללחוץ לחיצה ארוכה על לחצן הפעלה/השהייה למשך שלוש שניות.

16 יש לפתוח את תושבת הפילטר.

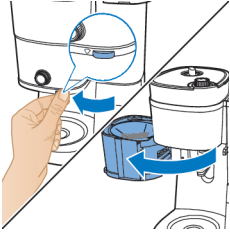

17 יש להסיר את פילטר הנייר המושמש.

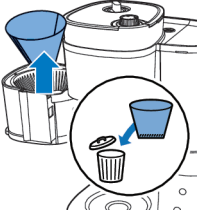

הגדרת הטיימר

כדי להגדיר את הטיימר במכשיר, יש לבצע את הפעולות הבאות:

- 1 יש להפעיל את מכונת הקפה.
- 2 יש ללחוץ על לחצן הטיימר, ואז סמל הטיימר יופיע על הצג. ספרות השעה מהבהבות כדי לציין את הגדרת השעה.

08:06 



- 3 יש להשתמש בלחצן החיצים כדי לכוון את השעות. אם ברצונך לכוון במהירות, יש ללחוץ לחיצה ארוכה על לחצן החיצים.

08:00



4 יש ללחוץ על לחצן הטיימר לאישור הגדרת השעה. ספרות הדקות מציינות את ערך הדקות.

08: ((🔔))



5 יש להשתמש שוב בלחצן החיצים כדי לכוון את הדקות. אם ברצונך לכוון במהירות, יש ללחוץ לחיצה ארוכה על לחצן החיצים.

08:06



6 יש ללחוץ שוב על לחצן הטיימר לאישור הגדרת הדקות.

כדי לבטל את הטיימר, ניתן ללחוץ על לחצן הטיימר, ואז סמל שעון הטיימר מהתצוגה.

פונקציית הפסקת הטפטוף מאפשרת לך להסיר את הקנקן ממכונת הקפה לפני שתהליך ההכנה מסתיים. עם הסרת הקנקן, פונקציית הפסקת הטפטוף עוצרת את זרימת הקפה לתוך הקנקן.

08:06 ((🔔))



הערה: הסרת קנקן הזכוכית אינה מפסיקה את תהליך הכנת הקפה. אם הקנקן לא יוחזר למכשיר תוך 20 דקות, סלסלת הפילטר תעלה על גדותיה.

ניקוי ותחזוקה

ניקוי קבוע בגמר כל שימוש

אסור לטבול את מכונת הקפה במים או בכל נוזל אחר ואין לשטוף אותה במים זורמים.

1 יש להוציא את תקע החשמל מהשקע שבקיר.

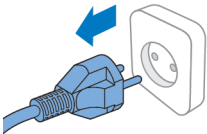









- 2 יש לנגב את חלקה החיצוני של מכונת הקפה במטלית נקיה.
- 3 יש לנקות את סלסלת הפילטר במים חמים עם נזל רחצת כלים או לנקות אותם במדיח כלים.



- 4 יש לנקות את קנקן הקפה והמכסה כדי לשטוף אותו תחת הברז. או לנקות במדיח הכלים.

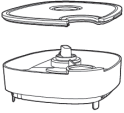

			
	✓	✓	✓
	✓	✓	✓
	✓	✓	✓
	✓	✗	✓
	✓	✗	✓

ניקוי משפך המטחנה

חשוב:

יש לנקות את משפך המטחנה פעם בשבוע עד שבועיים כדי למנוע ממנו סתימה על ידי קפה טחון. אפשר לעשות זאת בקלות ובמהירות לפי השלבים שלהלן.

יש לנקות את משפך המטחנה כאשר אתה מבחין שמופיעה התראת מברשת על גבי התצוגה.

הערה: יש לוודא שמכל פולי הקפה ריק לפני תחילת תהליך הניקוי.

1 כעת אפשר לחבר את המכשיר לחשמל.

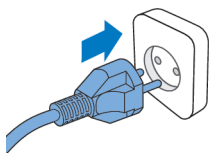

2 יש לפתוח את תושבת הפילטר כדי לגשת אל פתח משפך הטחינה.

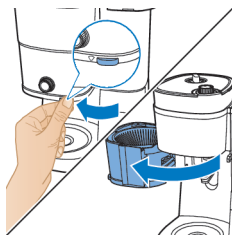

3 יש להפעיל את מכונת הקפה.

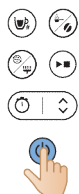

4 יש ללחוץ על לחצן הניקוי בלוח הבקרה של הכלי.

5 יש לבחור את הגדרת המברשת במסך התצוגה.

☞



⏻

6 יש ללחוץ על לחצן ההפעלה. פעולה זו תפתח את מכסה פתח יציאת הפולים ותאפשר לך לנקות את הפתח עם מברשת.



☞



⏻

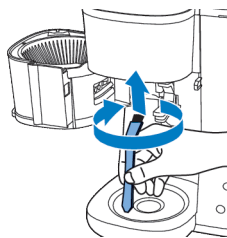

7 יש להשתמש במברשת כדי להסיר כל קפה טחון או שאריות שהצטברו בפתח.



8 לאחר ניקוי הפתח, יש ללחוץ על לחצן ההפעלה כדי לסגור את המכסה.

הסרת אבנית ממכונת הקפה
יש לבצע הסרת אבנית בכל פעם שמופיעה התראת הסרת אבנית על גבי התצוגה. בהסרת אבנית יש להשתמש בחומץ לבן בלבד, כיוון שחומרים אחרים עלולים לגרום נזק למכונת הקפה.

אזהרה: אסור להשתמש בחומץ עם תכולת חומצה אצטית של 8% או יותר, חומץ טבעי, אבקות הסרת אבנית או טבליות הסרת אבנית, כיוון שזה עלול לגרום נזק למכונה.

1 יש לפתוח את מכסה מכל המים.

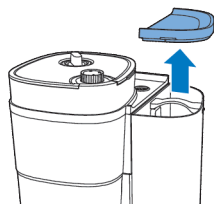

2 יש למלא את מכל המים בחומץ לבן (4% חומצה אצטית) עד הפס המסמן נפח 10 כוסות.

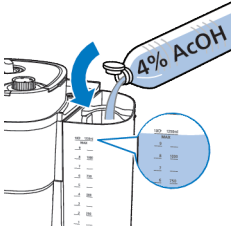

3 יש לסגור את המכסה של מכל המים.

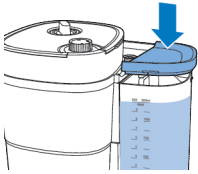

4 יש לאחוז בלשונית כדי לפתוח את תושבת הפילטר.

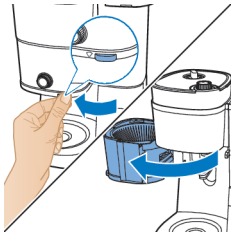

5 יש להניח פילטר נייר (סוג 1x4 או מספר 4) בתוך סלסלת הפילטר ולסגור את מחזיק סלסלת הפילטר.

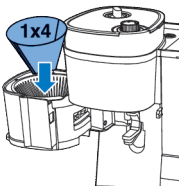

6 יש לשים את הקונקן הריק במכונת הקפה.

7 הכניסו את התקע לשקע שבקיר.

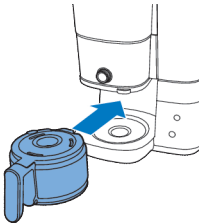

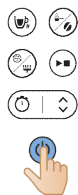

8 יש ללחוץ על לחצן הפעלה/כיבוי כדי להפעיל את מכונת הקפה. התצוגה נדלקת.

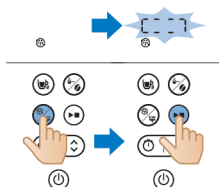

9 יש ללחוץ על לחצן הניקוי במכונת הקפה.

10 יש לבחור בהגדרת הסרת אבנית.

11 יש ללחוץ על לחצן ההפעלה כדי לאשר את בחירתך.

- מכונת הקפה תתחיל באופן אוטומטי בתהליך הסרת האבנית.

12 יש להמתין עד שהמכונה תסיים להרתיח את נוזל הסרת האבנית.

13 לאחר השלמת תהליך הסרת הריקון, יש לשטוף את הכלי פעמיים עם כמות מים מרבית כדי להסיר לחלוטין את כל שאריות הניקוי.

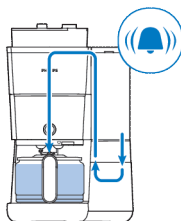

14 יש לרוקן את הקנקן ולהסיר את פילטר הנייר עם משקעי פעולת הניקוי.

15 יש למלא במים קרים וטריים את מכל המים וללחוץ על לחצן ההפעלה כדי להתחיל תהליך הרתחה נוסף.

יש לאפשר למכונת הקפה להשלים את כל תהליך הבישול ולאחר מכן לרוקן את הקנקן.

הערה: במידת הצורך, יש לחזור על שלב 14 עד שמכונת הקפה תוציא מים ללא טעם או ריח של חומץ.

16 יש לנקות את סלסלת הפילטר ואת הקנקן עם מים חמים ומעט נוזל רחצת כלים.

17 יש ללחוץ על לחצן הפעלה/כיבוי כדי לכבות את המכשיר.



פתרון בעיות

פרק זה מסכם את הבעיות הנפוצות ביותר במכשיר. אם לא ניתן לפתור את הבעיה בעזרת המידע שלהלן, בקרו באתר www.philips.com/support לקבלת רשימה של שאלות נפוצות, או פנו למרכז שירות הלקוחות במדינתכם.

באפשרותך גם לסרוק את קוד ה-QR לקבלת תמיכה מקוונת נוספת.



בעיה	פתרון
מכונת הקפה לא פועלת.	יש להכניס את התקע לשקע שבקיר ולחוץ על לחצן ההפעלה/כיבוי במכונת הקפה.
יש לוודא שהמתח המצוין על מכונת הקפה מתאים למתח החשמל המקומי.	
יש למלא את מכל המים במים.	
יש לסגור את המכסה של משפך המטחנה.	
המטחנה לא עובדת או לא עובדת כראוי.	יש לוודא שלא בחרת באפשרות קפה טחון מראש. אם סמל הקפה הטחון מוצג על גבי התצוגה, בחרת בקפה טחון מראש.
יש לנקות את משפך המטחנה על פי ההוראות.	
בשימוש במטחנה, הקפה חלש מדי.	יש לסובב את ידית מידת הטיחנה כדי לבחור את המידה הרצויה, בין דק לגס.
יש להשתמש בלחצן בחירת חוזק הקפה כדי להגדיר את חוזק הקפה בין 1 ל-3 כאשר הספרה הגדולה יותר פירושה חוזק רב יותר.	
יש להשתמש בפולי קפה מתערובת חזקה יותר או עם טעם חזק יותר.	
בשימוש בקפה טחון מראש, הקפה חלש מדי.	יש לוודא שכמות הקפה הטחון בפילטר מתאימה לכמות המים במכל המים. יש לשים לב שמכונת הקפה משתמשת בכל המים שבמכל המים.
יש להשתמש בקפה טחון מתערובת חזקה יותר או עם טעם חזק יותר.	
כדי להגביר את עוצמת הקפה, ניתן להגדיל את כמות הקפה הטחון או להקטין את כמות המים.	
המסנן עלה על גדותיו כשהסרת את הקנן ממכונת הקפה בזמן תהליך בישול הקפה.	אם הקנן מוסר למשך מעל 20 שניות במהלך תהליך הכנת הקפה, פונקציית הפסקת הטפטוף תגרום לסלסלת הפילטר לעלות על גדותיה. כמו כן, חשוב לדעת שהקפה אינו מגיע לטעמו המלא לפני סיום תהליך ההכנה. לכן אנו ממליצים שלא להסיר את הקנן ולשפוך את הקפה לפני סוף תהליך ההכנה.
מכונת הקפה ממשיכה לטפטף זמן רב לאחר שתהליך ההכנה הסתיים.	הטפטוף נגרם על ידי עיבוי של אדים. זה נורמלי לחלוטין שמכונת הקפה תטפטף במשך זמן מה.
אין באפשרותי לחכות לטיפות האחרונות.	יש לסובב את הידית ממצב כוס למצב קנן כדי להפעיל את פונקציית הפסקת הטפטוף, שתעצור את הטפטוף מסלסלת הפילטר.
אם הטפטוף לא נעצר, ייתכן שמפסיק הטפטוף סתום. כדי לנקות את מפסיק הטפטוף, יש לפתוח את תושבת סלסלת הפילטר ולהוציא את סלסלת הפילטר. יש לשטוף את סלסלת הפילטר ואת מפסיק הטפטוף מתחת לברז.	
הקפה לא מספיק חם.	הקפה בכד מתקרר מהר יותר בבישול כמות קטנה של כוסות. הקפה נשאר חם יותר בבישול 10 כוסות, שהן קנן מלא.
הסרת אבנית ממכונת הקפה.	

נראה כי פולי הקפה נגמרים במהירות. כדי להכין כוס קפה מושלמת, מכונת הקפה זקוקה לכמות מסוימת של קפה טחון. כמות פולי הקפה שמכונת הקפה משתמשת בהם כדי להשיג את הכמות האופטימלית של קפה טחון לכוס היא נורמלית.

הטיימר אינו עובד. חשוב להקפיד על השלמת כל שלבי הכנת הקפה, עם פולי קפה או קפה טחון מראש, לפני הגדרת הטיימר.

קוד שגיאה

קוד שגיאה	תיאור	פתרון	הערה
E1	Water shortage (מחסור במים)	יש ללחוץ על לחצן כלשהו כדי להעביר את המכשיר למצב המתנה. יש למלא שוב את מכל המים ולהפעיל מחדש את המכשיר.	אם הבעיה נמשכת, יש לבצע את הפעולות הבאות: יש ללחוץ לחיצה ארוכה על לחצני הניקוי וההפעלה בו-זמנית, למשך שלוש שניות, עד שהמכשיר יתחיל לשאוב מים באופן אוטומטי למשך דקה אחת. יש לחזור על התהליך 3 פעמים. יש לפנות לשירות הלקוחות אם הבעיה עדיין נמשכת.
E2	Bean container unavailable (מיכל פולי הקפה אינו זמין)	יש ללחוץ על לחצן כלשהו כדי להעביר את המכשיר למצב המתנה. יש לחבר היטב את מכל פולי הקפה ולהפעיל מחדש את המכשיר.	יש לפנות לשירות הלקוחות אם הבעיה נמשכת.
E3	Heating tube -malfunctioning (בעיה בצינור החימום)	כעת יש לנתק את המכשיר מהחשמל. יש לחבר את המכשיר ולהפעיל אותו שוב עד שהוא יתקרר לגמרי.	יש לפנות לשירות הלקוחות אם הבעיה נמשכת.
E4	Grinding wheel blockage (חסימה בגלגל הטחינה)	כעת יש לנתק את המכשיר מהחשמל. יש לחבר את המכשיר ולהפעיל אותו שוב. יש לעקוב אחר השלבים בסעיף "ניקוי משפך המטחנה" כדי לנקות את גלגל הטחינה ואת משפך המטחנה.	יש לפנות לשירות הלקוחות אם הבעיה נמשכת.
E5	Ground funnel chute blockage (חסימה בפתח משפך הטחינה)	כעת יש לנתק את המכשיר מהחשמל. יש לחבר את המכשיר ולהפעיל אותו שוב. יש לעקוב אחר השלבים בסעיף "ניקוי משפך המטחנה" כדי לנקות את פתח משפך המטחנה.	יש לפנות לשירות הלקוחות אם הבעיה נמשכת.
E6/E7/ E8	Program error (שגיאת תכנית)	כעת יש לנתק את המכשיר מהחשמל. יש לחבר את המכשיר ולהפעיל אותו שוב.	יש לפנות לשירות הלקוחות אם הבעיה נמשכת.

2023 © Versuni Holding B.V.

PHILIPS and the Philips Shield Emblem are registered trademarks of Koninklijke Philips N.V. and are used under license.

This product has been manufactured by and is sold under the responsibility of Versuni Holding B.V., and Versuni Holding B.V. is the warrantor in relation to this product.

xxxx.yy.zzzz.a (07/2023)



 >75 % recycled paper
>75 % papier recyclé